



ultra **site**®

A PLAYCORE



LIFE'S INTERMISSION



*site furnishings
& park amenities*



Distributed by: Efficient Amenities



EFFICIENT AMENITIES

Call Us Today.



(855) 884-8387

7 REASONS TO CHOOSE THE SUPERIOR
PERFORMANCE OF **ULTRACOAT**

UltraCoat is a premium thermoplastic coating by UltraSite® with superior adhesion that creates a seal tight bond to the metal surface and ensures a smooth, shiny finish without the use of PVC.

SUPERIOR
ADHESION



RESISTANCE TO
CUTTING AND
VANDALISM



ENVIRONMENTALLY
FRIENDLY



NO RUNS
OR DRIPS



UV PROTECTION

EASILY
REPAIRED



SMOOTH
FINISH
PREVENTS
MOLD AND
MILDEW



Distributed by: Efficient Amenities



**EFFICIENT
AMENITIES**

Call Us Today.



(855) 884-8387



02

PREMIUM COLLECTION

Features sleek designs to enhance any landscape.

Wilmington	3	Oxford	11
Hartford	4	Kensington	12
Savannah	5	Charleston	13
Hamilton	6	Durham	14
Augusta	7	Lexington	15
Huntington	8	Madison	16
Richmond	9-10	Palmetto	17

18

ULTRACOAT COLLECTION

Features premium thermoplastic coating for lasting durability.

Benches	18-27
Tables	28-41
Receptacles/Planters	42-49
Customization	50-51
Early Childhood	52-55

56

NATURAL COLLECTION

Features 100% recycled plastic, wood & aluminum for a more natural look.

Recycled Benches	56-59
Recycled Tables	60-64
Recycled Planters/Receptacles	65-66
100% Recycled	67
Aluminum	68
Recycled Early Childhood	69

70

ACCESSORIES

Add matching accessories to complete your space.

Receptacles & Planters	71
Umbrellas	72-73
Bollards	74-75
Bike Racks	76-78
Grills	79-80
Recreation	81

82

SHOWCASE

Transform your outdoor space into a community destination.

BarkPark	83-85
ActionFit	86-87
UltraShade/UltraShelter	88
Dero	89
Grandstands	90
Colorado Time Systems	91

92

SPECIFICATIONS

Selection Guide	92-93
Warranties	94
Plank & Color Options	95-97



PREMIUM COLLECTION



974-56 [phone icon] Wilmington Bench, vertical slats, ultra silver metallic



Distributed by: Efficient Amenities



EFFICIENT AMENITIES

Call Us Today.



(855) 884-8387

WILMINGTON
COLLECTION



974-S6 6' Wilmington Bench, vertical slats, ultra silver metallic

974 | WILMINGTON BENCH

The Wilmington Bench features high arching arms and your choice of vertical or horizontal slats.

- 4', 6', and 8' lengths
- Cast aluminum frame with powder coated finish
- Bolt together design
- All MIG Welded
- All stainless steel hardware
- Available in vertical or horizontal slats
- Portable (P) and/or surface mount (SM)
- See page 97 for color options



974-HS6 6' Wilmington Bench, horizontal slats, matte black

	4 FOOT	6 FOOT	8 FOOT
Vertical Slats	974-S4	974-S6	974-S8
Horizontal Slats	974-HS4	974-HS6	974-HS8



CL-36 Classic Swing Door Receptacle, vertical slat, black with matching flat top lid

CL-36 | CLASSIC SWING DOOR RECEPTACLE

- 1/4" x 1-1/2" steel flat bar
- All MIG welded frame
- Only available in powder coated finish
- All stainless steel hardware
- Portable and/or surface mount
- Lid and liner included

FLAT TOP LID	ASH URN LID	RAIN BONNET LID
CL-36FT	CL-36AU	CL-36RB



HARTFORD
COLLECTION



10-RDHS Hartford Table, Blue Vein



11SM-HS4 4' Hartford Bench, Black

NEW 11/12 | HARTFORD BENCH

- 4' and 6' lengths
- Powder coated finish
- Available with (11) or without back (12)
- Inground (S) or surface mount (SM)
- See page 97 for color options

	4 FOOT	6 FOOT
11 SERIES	11-HS4	11-HS6
12 SERIES	12-HS4	12-HS6



10-RDHS Hartford Table, Black

NEW 10-RDHS | HARTFORD TABLE

- 36" solid table top with umbrella hole
- Powder coated finish
- Portable and/or surface mount
- See page 97 for color options



SAVANNAH
COLLECTION



SV-B32FT Savannah Trash Receptacle, Green



922-S6 6' Savannah Bench, slat, black



922 | SAVANNAH BENCH

- 4', 6', and 8' lengths
- Standard in thermoplastic
- Powder coat available for an upcharge
- 2" x 2" all MIG welded square tube frame
- All stainless steel hardware
- Portable and/or surface mount
- See page 97 for color options

4 FOOT	6 FOOT	8 FOOT
922-B4	922-B6	922-B8
922-M4	922-M6	922-M8
922-S4	922-S6	922-S8

SV-32 | TRASH RECEPTACLE



SV-B32FT Trash Receptacle, slat, black

- 32 gallon capacity
- 29" square x 33-1/2" high
- Standard in thermoplastic
- Powder coat available for an upcharge
- Lid and plastic liner included
- 2" x 2" all MIG welded square tube frame
- Portable and/or surface mount
- See page 97 for color options

FLAT TOP LID	ASH URN LID	RAIN BONNET LID
SV-B32FT	SV-B32AU	SV-B32RB
SV-M32FT	SV-M32AU	SV-M32RB
SV-S32FT	SV-S32AU	SV-S32RB



HAMILTON
COLLECTION



LX-36RB Lexington Trash Receptacle, vertical slat, spartan bronze with matching lid



92-S6 6' Hamilton Bench without Back, vertical slat, black

91/92 | HAMILTON BENCH

- 2', 4', 6', or 8' lengths
- Fully welded bench with powder coated finish
- Vertical or Horizontal Slats
- Frame is a 1" x 1" square solid steel bar
- Ships assembled for quick installation
- Available with (91) and without back (92)
- Portable and/or surface mount
- Optional Center Arm (C) and No Side Arms (N)
- See page 97 for color options

91 SERIES	2 FOOT	4 FOOT	6 FOOT	8 FOOT
Vertical Slats	91-S2	91-S4	91-S6	91-S8
Horizontal Slats	91-HS2	91-HS4	91-HS6	91-HS8

92 SERIES	4 FOOT	6 FOOT
Vertical Slats	92-S4	92-S6
Horizontal Slats	92-HS4	92-HS6



364-RDSD Hamilton Table, solid table top with 91-S2 2' Hamilton Bench, vertical slat, brown finish

364/30 | HAMILTON TABLE

- The 30 round table comes complete with 2, 3, or 4 freestanding seats, powder coated finish, and inground or surface mount
- The portable 364 table has a round solid top with a powder coated finish (chairs not included)
- Inground or surface mount (30) and portable (364)
- See page 97 for color options



30-S Hamilton Table with 4 seats, vertical slat, black

364 SERIES	ROUND
	364-RDSD

30 SERIES	4 SEATS	3 SEATS (Single Access)	2 SEATS (Double Access)
	30-S	30H-S	30H2-S



AUGUSTA
COLLECTION



93N-HS6 6' Augusta Bench with Back, no arm rests, spartan bronze



94N-HS6 6' Augusta Bench with Back, no arm rests, spartan bronze

93/94 | AUGUSTA BENCH

- 6' length
- Powder coated finish
- All MIG welded
- Legs are made from 3/4" laser cut steel plate
- Fully welded
- Available with (93) and without back (94)
- Portable and/or surface mount
- Optional Center Arm (C), and No Side Arms (N)
- See page 97 for color options

93 SERIES	6 FOOT
No Arms	93N-HS6
Side & Center Arms	93C-HS6
Side Arms	93-HS6

94 SERIES	6 FOOT
No Arms	94N-HS6
Side Arms	94-HS6

AG-36 | AUGUSTA RECEPTACLE



AG-36FT Augusta Receptacle, vertical slat, flat top lid, spartan bronze

- 36 gallon capacity
- Only available in powder coated finish
- 1-1/2" x 1/4" flat steel strips
- Top and bottom rings are 1" pipe
- All MIG welded frame
- Portable and/or surface mount
- Lid and liner included
- See page 97 for color options

FLAT TOP	ASH URN	RAIN BONNET
AG-36FT	AG-36AU	AG-36RB



HUNTINGTON COLLECTION

52-HX6 6' Huntington Bench without Back, spartan bronze



53-HX6 6' Huntington Bench with Back, spartan bronze

52/53 | HUNTINGTON BENCH

- 2', 4', 6' and 8' lengths available
- 1-1/2" square tubing
- Features hexagonal geometric shapes and straight lines for a modern look
- Available with (53) or without back (52)
- Portable and/or surface mount
- Powder coated finish and ships fully assembled
- Fully welded
- See page 97 for color options

	2 FOOT	4 FOOT	6 FOOT	8 FOOT
52 SERIES	—	52-HX4	52-HX6	52-HX8
53 SERIES	53-HX2	53-HX4	53-HX6	53-HX8



50SM-HX Huntington Table with 4 Chairs, spartan bronze

50 | HUNTINGTON TABLE WITH 4 CHAIRS

- Features solid powder coated table top with four chairs
- Chairs feature both 1-1/2" and 1" square tubing
- Chairs can also be purchased separately without the table
- Portable and/or surface mount
- See page 97 for color options

TABLE WITH 4 CHAIRS	CHAIR
50SM-HX	53-HX2



51-HXFT Huntington Receptacle, flat top lid, spartan bronze with burgundy backing

51-HX | HUNTINGTON RECEPTACLE

- See page 43 for more information

FLAT TOP	ASH URN	RAIN BONNET
51-HXFT	51-HXAU	51-HXRB





RICHMOND
RECYCLED COLLECTION

61S-CDR6 6' Richmond Bench with Back, cedar style recycled plastic planks, black frame



62SM-CDR6 6' Richmond Bench without Back, cedar style recycled plastic planks, black frame

61/62 | RICHMOND BENCH WITHOUT BACK

- 6' length
- Features 3" square tubing legs
- Available with (61) and without back (62)
- Recycled plastic planks with powder coated frame finish
- Inground (S) or surface mount (SM)
- See page 95 for plank color options

61 SERIES

61-GRY6

61-CDR6

61-BRN6

61-GRN6

62 SERIES

62-GRY6

62-CDR6

62-BRN6

62-GRN6



64-CDR6 6' Richmond Pedestal Table, portable, cedar recycled plastic planks, black frame

63/64 | RICHMOND TABLE

- 6' length
- 2" x 4" recycled plastic planks with powder coated frame
- 2-3/8" O.D. frames
- Available as a multi pedestal table (63) or portable table with a walk-through design (64)
- Inground or surface mount (63) and portable (64)
- See page 95 for plank color options

63 SERIES

63-GRY6

63-CDR6

63-BRN6

63-GRN6

64 SERIES

64-GRY6

64-CDR6

64-BRN6

64-GRN6



60-CDR34 Richmond Trash Receptacle, cedar recycled plastic planks

60 | RICHMOND TRASH RECEPTACLE

- See page 66 for more information

TRASH RECEPTACLE

60-CDR34



RICHMOND
STEEL COLLECTION

82-HS6 6' Richmond Bench without Back, black slats, black frame



81S-HS6 6' Richmond Bench with Back, ultra blue

81 | RICHMOND BENCH WITH BACK

- 6' length
- Features 3" square tubing legs
- Available with or without arm rests
- Horizontal powder coated metal slats
- Inground (S) or surface mount (SM)
- See page 97 for color options

W/O ARMRESTS	WITH ARMRESTS
81-HS6	81C-HS6



82 | RICHMOND BENCH WITHOUT BACK

- 6' length
- Features 3" square tubing legs
- Available with or without arm rests
- Horizontal powder coated metal slats
- Inground (S) or surface mount (SM)
- See page 97 for color options

W/O ARMRESTS	WITH ARMRESTS
82-HS6	82C-HS6

82C-HS6 6' Richmond Bench without Back, with armrests, matte black



OXFORD
COLLECTION



86-S6 6' Oxford Bench with Back, ultra blue



86-S6 6' Oxford Bench with Back, ultra blue

NEW 86 | OXFORD BENCH WITH BACK

- 4' and 6' lengths
- UltraCoat thermoplastic finish
- 7 gauge steel seat with 3/8" steel plate legs
- Fully welded design
- Portable and/or surface mount
- See page 97 for color options

4 FOOT	6 FOOT
86-S4	86-S6

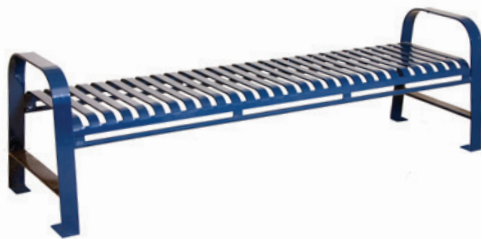

85-S6 6' Oxford Bench without Back, ultra blue

NEW 85 | OXFORD BENCH WITHOUT BACK

- 4' and 6' lengths
- UltraCoat thermoplastic finish
- 7 gauge steel seat with 3/8" steel plate legs
- Fully welded design
- Portable and/or surface mount
- See page 97 for color options

4 FOOT	6 FOOT
85-S4	85-S6



OX-36FT Oxford Receptacle, ultra blue vertical slat with matching flat top lid

NEW OX-36 | OXFORD RECEPTACLE

- See page 45 for more information

FLAT TOP	ASH URN	RAIN BONNET
OX-36FT	OX-36AU	OX-36RB



KENSINGTON
COLLECTION



43SM-S6 6' Kensington Bench with Back, black with 41-SD Kensington Receptacle, black



44SM-S6 6' Kensington Bench without Back, black

43/44 | KENSINGTON BENCH

- 6' length
- Powder coated finish
- Available with (43) or without back (44)
- Inground (S) or surface mount (SM)
- See page 97 for color options

6 FOOT

43 SERIES	43-S6
44 SERIES	44-S6



40SM-S Kensington Square Pedestal Table with 4 seats, black



42-RDS Kensington Round Solid Top Table with 3 seats, black

40/42 | KENSINGTON TABLE

- Choose between the single pedestal square table with four seats (40) or the round table with three seats (42)
- Series 40 features a rolled slat table top and series 42 features a solid top
- Feature seats that are fabricated from a 1/4" steel plate with rolled slats
- Powder coated finish
- The 40 is available inground (S) or surface mount (SM), the 42 can be portable and/or surface mount
- See page 97 for color options

	SURFACE MOUNT	INGROUND
40 SERIES	40SM-S	40S-S
42 SERIES	42-RDS	—

See page 43 for matching Kensington Receptacle



CHARLESTON
COLLECTION



964-S6 6' Charleston Bench with Back, slat, black



964-S6 6' Charleston Bench with Back, slat, green

964 | CHARLESTON BENCH WITH BACK

- 4', 6', and 8' lengths
- Thermoplastic finish
- 1-1/2" thick cast aluminum frame
- All stainless steel hardware
- Portable and/or surface mount
- Use code (AO) for add-on sections
- See page 97 for color options and 98 for pattern options

4 FOOT	6 FOOT	8 FOOT
964-V4	964-V6	964-V8
964-P4	964-P6	964-P8
964-FB4	964-FB6	964-FB8
964-W4	964-W6	964-W8
964-S4	964-S6	964-S8



968-S4 4' Charleston Bench without Back, wave, green

968 | CHARLESTON BENCH WITHOUT BACK

- 4', 6', and 8' lengths
- Thermoplastic finish
- 1-1/2" thick cast aluminum frame
- All stainless steel hardware
- Portable and/or surface mount
- Use code (AO) for add-on sections
- See page 97 for color options and 96 for pattern options

4 FOOT	6 FOOT	8 FOOT
968-V4	968-V6	968-V8
968-P4	968-P6	968-P8
968-FB4	968-FB6	968-FB8
968-W4	968-W6	968-W8
968-S4	968-S6	968-S8



DURHAM
COLLECTION

99-S6 6' Durham Bench with Back, vertical slats, black



99-S6 Durham Bench with Back, black vertical slats

99 | DURHAM BENCH WITH BACK

- 4' and 6' lengths available
- Available in horizontal or vertical powder coated metal slats
- Also available in 2' x 4" recycled slats
- Cast aluminum frame
- Portable and/or surface mount
- See page 97 for color options

4 FOOT

99-HS4

99-GRY4

99-CDR4

99-BRN4

99-GRN4

6 FOOT

9-HS6

99-GRY6

99-CDR6

99-BRN6

99-GRN6

98 | DURHAM BENCH WITHOUT BACK

- 4' and 6' lengths available
- Available vertical powder coated metal slats
- Cast aluminum frame
- Also available in 2' x 4" recycled slats
- Portable and/or surface mount
- See page 97 for color options



98-S4 4' Durham Bench without Back, vertical slats, blue powder coated finish, black frame

4 FOOT

98-S4

98-GRY4

98-CDR4

98-BRN4

98-GRN4

6 FOOT

98-S6

98-GRY6

98-CDR6

98-BRN6

98-GRN6



LEXINGTON
COLLECTION



954-P6-LL Lexington Bench with Back, perforated with custom laser letter, red



954-V6 6' Lexington Bench with Back, diamond

954 | LEXINGTON BENCH WITH BACK

- 4', 6', and 8' lengths
- UltraCoat® thermoplastic finish
- 1-1/2" thick cast aluminum frame
- All stainless steel hardware
- Portable and/or surface mount
- Add-ons optional (Example: 954AO-V4)
- See page 97 for color options and 96 for pattern options

4 FOOT	6 FOOT	8 FOOT
954-V4	954-V6	954-V8
954-P4	954-P6	954-P8
954-FB4	954-FB6	954-FB8
954-W4	954-W6	954-W8
954-S4	954-S6	954-S8

958 | LEXINGTON BENCH WITHOUT BACK

- 4', 6', and 8' lengths
- UltraCoat® thermoplastic finish
- 1-1/2" thick cast aluminum frame
- All stainless steel hardware
- Portable and/or surface mount
- Add-ons optional (Example: 958AO-V4)
- See page 97 for color options and 96 for pattern options



958-P4 4' Lexington Bench without Back, perforated

4 FOOT	6 FOOT	8 FOOT
958-V4	958-V6	958-V8
958-P4	958-P6	958-P8
958-FB4	958-FB6	958-FB8
958-W4	958-W6	958-W8
958-S4	958-S6	958-S8

See page 44 for matching Lexington Receptacle & page 49 for matching Lexington Planter



MADISON
COLLECTION

72-16 6' Madison Bench with Ipe Wood, spartan bronze frame



71-S6 6' Madison Bench with Powder Coated Finish, matte black

71/72/73 | MADISON BENCH

- 4', 6', and 8' lengths available
- 3/4" steel plate legs reinforced with 1/4" thick support bars
- Powder coated steel slats are 1/4" x 5"
- Available with (71) and without back (73)
- Without back option also available without armrests (72)
- Portable and/or surface mount
- See page 97 for color options

	4 FOOT	6 FOOT	8 FOOT
71 SERIES	71-S4	71-S6	71-S8
72 SERIES	72-S4	72-S6	72-S8
73 SERIES	73-S4	73-S6	73-S8

71/72/73 | MADISON BENCH WITH
IPE WOOD FINISH



72-16 6' Madison Bench with Ipe Wood, no armrests, spartan bronze frame

- 4', 6', and 8' lengths available
- 3/4" steel plate legs reinforced with 1/4" thick support bars
- Ipe wood comes in 1-1/4" x 6" planks and are cut to length and predrilled
- Planks are sealed on each end to prevent splitting and stained with a wood finish
- Available with (71) and without back (73)
- Without back option also available without armrests (72)
- Portable and/or surface mount

	4 FOOT	6 FOOT	8 FOOT
71 SERIES	71-I4	71-I6	71-I8
72 SERIES	72-I4	72-I6	72-I8
73 SERIES	73-I4	73-I6	73-I8



PALMETTO
COLLECTION



800-RS3 Palmetto Bench, 3-seat, black



800-RS3 Palmetto Bench, 3-seat, black

800 | PALMETTO BENCH

- 2, 3, and 4 seat options
- Powder coated finish
- Manufactured with 5/8" steel rods
- 23" wide seats
- All stainless steel hardware
- Portable (P), surface mount (SM), or inground (S)
- See page 97 for color options

2 SEAT	3 SEAT	4 SEAT
800-RS2	800-RS3	800-RS4

SV-R32 | PALMETTO TRASH RECEPTACLE

- 32 gallon capacity
- 29" square x 33-3/16" high
- Powder coated finish
- Manufactured with 5/8" steel rods
- Portable (P) or surface mount (SM)
- Liner and lid included
- See page 97 for color options



SV-R32FT Palmetto Trash Receptacle with Flat Top, black

FLAT TOP LID	ASH URN LID	RAIN BONNET LID
SV-R32FT	SV-R32AU	SV-R32RB



ULTRACOAT

ULTRACOAT COLLECTION
—
BENCHES



942SM Extra Heavy Duty Bench without Back, red with diamond rolled pattern, black frame



Distributed by: Efficient Amenities



**EFFICIENT
AMENITIES**

Call Us Today.



(855) 884-8387



Check out our
Buddy Bench
on pg. 52

940S-PR6 6' Extra Heavy Duty Bench with Back, inground, blue perforated rolled seating pattern, black frame



940P-P6 6' Extra Heavy-Duty Bench with Back, portable, green perforated pattern, black frame

940 | EXTRA HEAVY-DUTY BENCH WITH BACK

The UltraSite® 940 Bench continues to be the most popular series at UltraSite®.

- Available in 6', 8', 10', and 15' lengths
- 12" seating standard or optional deluxe (D) 15" seating
- Thermoplastic finish with powder coated frame
- 2-3/8" O.D. all MIG welded frame
- 1" O.D. brace (Portable frame only)
- All stainless steel hardware
- Portable (P), inground (S), surface mount (SM), or wall mount (WM)
- Cover Plates available for inground (S) and surface mount (SM)
- See page 97 for color options and 96 for seating patterns

6 FOOT	12" seating	(D) 15" seating
	940-V6	940-DV6
	940-VR6	940-DVR6
	940-P6	940-DP6
	940-PR6	940-DPR6
	940-FV (frame only)	

8 FOOT	12" seating	(D) 15" seating
	940-V8	940-DV8
	940-VR8	940-DVR8
	940-P8	940-DP8
	940-PR8	940-DPR8
	940-FV (frame only)	

10 FOOT	12" seating	(D) 15" seating
	940-V10	940-DV10
	940-P10	940-DP10
	940-FV10 (10' frame only)	

15 FOOT	12" seating	(D) 15" seating
	940-V15	940-DV15
	940-P15	940-DP15
	940-FV15 (15' frame only)	





942S-V15 15' Extra Heavy-Duty Bench without Back, inground, blue diamond pattern, black frame



942SM-P6 6' Extra Heavy-Duty Bench without Back, surface mount, green perforated pattern, black frame

942 | EXTRA HEAVY-DUTY BENCH WITHOUT BACK

- Available in 6', 8', 10', and 15' lengths
- 12" seating standard or optional deluxe (D) 15" seating
- Thermoplastic finish with powder coated frame
- 2-3/8" O.D. all MIG welded frame
- 1" O.D. brace (Portable frame only)
- All stainless steel hardware
- Portable (P), inground (S), surface mount (SM), or wall mount (WM)
- Cover Plates available for inground (S) and surface mount (SM)
- See page 97 for color options and 96 for seating patterns

10 FOOT	12" seating	(D) 15" seating
	942-V10	942-DV10
942-P10	942-DP10	
	942-FV10 (10' frame only)	

15 FOOT	12" seating	(D) 15" seating
	942-V15	942-DV15
942-P15	942-DP15	
	942-FV15 (15' frame only)	

6 FOOT	12" seating	(D) 15" seating
	942-V6	942-DV6
	942-VR6	942-DVR6
	942-P6	942-DP6
942-PR6	942-DPR6	
	942-FV (frame only)	

8 FOOT	12" seating	(D) 15" seating
	942-V8	942-DV8
	942-VR8	942-DVR8
	942-P8	942-DP8
942-PR8	942-DPR8	
	942-FV (frame only)	



970-V6 6' Cantilevered Bench, inground, blue diamond pattern, black frame

970 | CANTILEVERED BENCH

- Available in 4', 6', and 8' lengths
- Thermoplastic finish with powder coated frame
- Heavy-duty 2-3/8" O.D. all MIG welded frame
- All stainless steel hardware
- Inground mount only
- See page 97 for color options and 96 for seating patterns

4 FOOT	6 FOOT	8 FOOT
970-V4	970-V6	970-V8
970-P4	970-P6	970-P8
970-FB4	970-FB6	970-FB8
970-W4	970-W6	970-W8
970-S4	970-S6	970-S8





932SM-P6 6' Mall Bench, surface mount, blue perforated pattern, black frame



934S-V6 6' Geometric Mall Bench, surface mount, green diamond pattern, black frame

934 | GEOMETRIC MALL BENCH

The Geometric Mall Bench (934) is designed to fit around objects or create geometric designs.

- Available in 6' and 8' lengths
- 6' Bench has 32" square center, 8' Bench has 56" square center
- 20" deep seat with 4" tall outside border
- Thermoplastic finish with powder coated frame
- 4" bollard-style square tubing
- All stainless steel hardware
- Inground (S) or surface mount (SM)
- Seating pattern options: perforated, diamond
- See page 97 for color options

6 FOOT	8 FOOT
934-V6	934-V8
934-P6	934-P8

932 | MALL BENCH

- Available in 4', 6', and 8' lengths
- 15" deep seat with 4" tall outside border
- Thermoplastic finish with powder coated frame
- All stainless steel hardware
- Inground (S) or surface mount (SM)
- Seating pattern options: perforated, diamond, wave
- See page 97 for color options

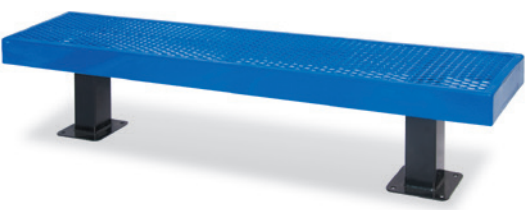

932SM-V6 6' Mall Bench, surface mount, blue diamond pattern, black frame

4 FOOT	6 FOOT	8 FOOT
932-V4	932-V6	932-V8
932-P4	932-P6	932-P8
932-W4	932-W6	932-W8





965SM-W4 4' Contour Bench with Back, surface mount, black wave pattern, spartan bronze frame



965SM-FB6 6' Contour Bench with Back, surface mount, blue fiesta pattern, black frame

965 | CONTOUR BENCH WITH BACK

- 4', 6', and 8' lengths can be extended with 4', 6', or 8' add-on (AO) benches
- Thermoplastic finish with powder coated frame
- 2-3/8" O.D. frame
- All stainless steel hardware
- Portable (P), inground (S), or surface mount (SM)
- Cover Plate available for inground (S) or surface mount (SM)
- See page 97 for color options and 96 for seating patterns

4 FOOT	6 FOOT	8 FOOT
965-V4	965-V6	965-V8
965-P4	965-P6	965-P8
965-FB4	965-FB6	965-FB8
965-W4	965-W6	965-W8
965-S4	965-S6	965-S8



966SM-P6 6' Contour Bench without Back, surface mount, green perforated pattern, black frame

966 | CONTOUR BENCH WITHOUT BACK

- 4', 6', and 8' lengths can be extended with 4', 6', or 8' add-on (AO) benches
- Thermoplastic finish with powder coated frame
- 2-3/8" O.D. frame
- All stainless steel hardware
- Portable (P), inground (S), or surface mount (SM)
- Cover Plate available for inground (S) or surface mount (SM)
- See page 97 for color options and 96 for seating patterns

4 FOOT	6 FOOT	8 FOOT
966-V4	966-V6	966-V8
966-P4	966-P6	966-P8
966-FB4	966-FB6	966-FB8
966-W4	966-W6	966-W8
966-S4	966-S6	966-S8





967-V6 6' Contour Bench Swing, blue diamond pattern, black frame

967 | CONTOUR BENCH SWING

- Available in 4' and 6' lengths
- 2-3/8" O.D. frame
- Thermoplastic finish with powder coated frame
- Uncoated galvanized swing chain
- Cover Plate available
- All stainless steel hardware
- Inground (S) mount only
- See page 97 for color options and 96 for seating patterns

4 FOOT	6 FOOT
967-V4	967-V6
967-P4	967-P6
967-FB4	967-FB6
967-W4	967-W6
967-S4	967-S6



976SM-V4 4' Contour Cantilevered Bench without Back, surface mount, blue diamond pattern, black frame

976 | CONTOUR CANTILEVERED BENCH WITHOUT BACK

- Available in 4', 6', and 8' lengths and can be extended with 4', 6', or 8' add-on (AO) benches
- Thermoplastic finish with powder coated frame
- Heavy-duty 2-3/8" O.D. all MIG welded frame
- All stainless steel hardware
- Inground (S) or surface mount (SM)
- See page 97 for color options and 96 for seating patterns

4 FOOT	6 FOOT	8 FOOT
976-V4	976-V6	976-V8
976-P4	976-P6	976-P8
976-FB4	976-FB6	976-FB8
976-W4	976-W6	976-W8
976-S4	976-S6	976-S8



975SM-W6 6' Contour Cantilevered Bench with Back, surface mount, red wave pattern, white frame

975 | CONTOUR CANTILEVERED BENCH WITH BACK

- Available in 4', 6', and 8' lengths and can be extended with 4', 6', or 8' add-on (AO) benches
- Thermoplastic finish with powder coated frame
- Heavy-duty 2-3/8" O.D. all MIG welded frame
- All stainless steel hardware
- Inground (S) or surface mount (SM)
- See page 97 for color options and 96 for seating patterns

4 FOOT	6 FOOT	8 FOOT
975-V4	975-V6	975-V8
975-P4	975-P6	975-P8
975-FB4	975-FB6	975-FB8
975-W4	975-W6	975-W8
975-S4	975-S6	975-S8

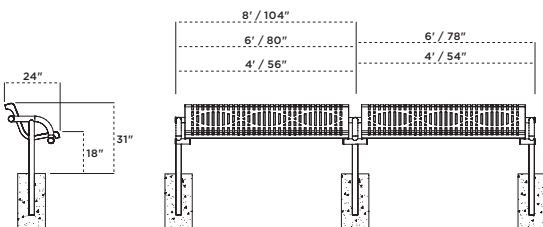



962SM-V6 6' Double-Sided Bollard Bench, surface mount, green diamond pattern, green frame



962SM-V6 6' Double-Sided Bollard Bench, surface mount, ultra blue diamond pattern, ultra blue frame

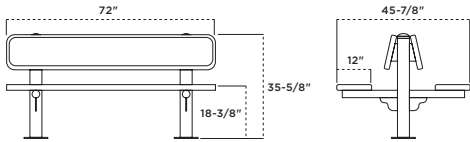

962 | BOLLARD STYLE BENCH

- Available in 6' and 8' lengths
- Thermoplastic finish with powder coated frame
- 4" bollard-style square post
- 2-3/8" O.D. all MIG welded seat support arm
- All stainless steel hardware
- Inground (S) or surface mount (SM)
- Seating pattern options: perforated rolled, diamond rolled
- See page 97 for color options

6 FOOT	8 FOOT
962-V6	962-V8
962-VR6	962-VR8
962-P6	962-P8
962-PR6	962-PR8



961SM-V6 6' Single-Sided Bollard Bench, surface mount, red diamond pattern, black frame

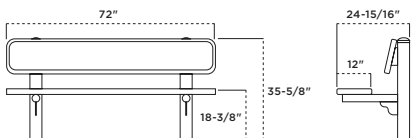

961 | BOLLARD STYLE BENCH

- Available in 6' and 8' lengths
- Thermoplastic finish with powder coated frame
- 4" bollard-style square post
- 2-3/8" O.D. all MIG welded seat support arm
- All stainless steel hardware
- Inground (S) or surface mount (SM)
- Seating pattern options: perforated, perforated rolled, diamond, diamond rolled
- See page 97 for color options

6 FOOT	8 FOOT
961-V6	961-V8
961-VR6	961-VR8
961-P6	961-P8
961-PR6	961-PR8





800-VS3 3-Seat Straight Bench with Back, portable, brown diamond pattern, brown frame

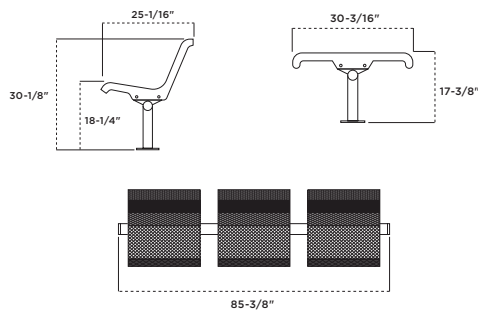

800/700 | STRAIGHT BENCH

- Thermoplastic finish with powder coated frame
- 2-3/8" O.D. all MIG welded frame
- 1-5/8" O.D. feet (portable only)
- All stainless steel hardware
- Portable (P), inground (S), or surface mount (SM)
- Available with (800) or without (700) back
- Available in 2 or 3 individual seat sections
- Sections can be placed side-by-side to create straight or oval configuring
- Seating pattern options: perforated, diamond, rod
- See page 97 for color options

WITH BACK	2 SEAT		3 SEAT		W/O BACK	2 SEAT		3 SEAT	
	800-VS2	800-VS3	700-VS2	700-VS3					
	800-PS2	800-PS3	700-PS2	700-PS3					
	800-RS2	800-RS3	700-RS2	700-RS3					

815 / 715 | 830 / 730 | CONCAVE AND CONVEX BENCHES

The 3-seat 815 & 715 series has 15° angles, while the 830 & 730 series has 30° angles. This allows the seating to be placed in a semi-circular arrangement.



715SM-VCA3 3-Seat Concave Bench without Back, surface mount, green diamond pattern, black frame

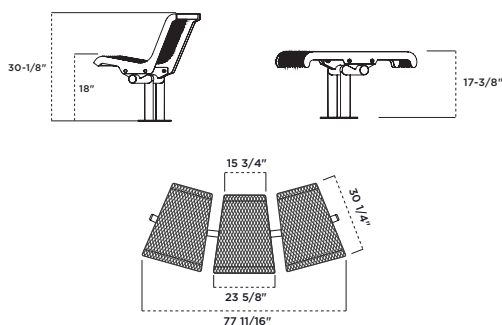

- Thermoplastic finish with powder coated frame
- 2-3/8" O.D. all MIG welded main support
- 1-5/8" O.D. feet (portable only)
- All stainless steel hardware
- Portable (P), inground (S), or surface mount (SM)
- Series 815 & 830 are with backs
- Series 715 & 730 are without backs
- Seating pattern options: perforated, diamond
- See page 97 for color options

815 / 715		830 / 730	
WITH BACK	W/O BACK	WITH BACK	W/O BACK
815-VCX3	715-VCX3	830-VCX3	730-VCX3
815-PCX3	715-PCX3	830-PCX3	730-PCX3
815-PCA3	715-PCA3		



BENCHES



955SM-W6 6' Sierra Bench, surface mount, red wave pattern, red frame

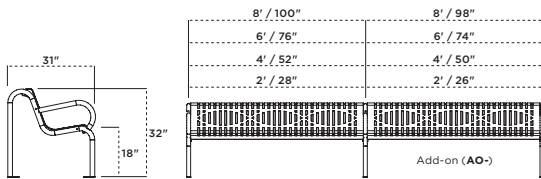

955 | SIERRA BENCH

- Available in 2', 4', 6', and 8' with optional add-on (AO) benches
- Thermoplastic finish with powder coated frame
- 1-5/8" O.D. all MIG welded frame
- All stainless steel hardware
- Portable (P), inground (S), or surface mount (SM)
- See page 97 for color options and 96 for seating patterns

BENCH	2 FOOT	4 FOOT	6 FOOT	8 FOOT
	955-V24	955-V4	955-V6	955-V8
	955-P24	955-P4	955-P6	955-P8
	955-FB24	955-FB4	955-FB6	955-FB8
	955-W24	955-W4	955-W6	955-W8
955-S24	955-S4	955-S6	955-S8	

ADD-ON	2 FOOT	4 FOOT	6 FOOT	8 FOOT
	955AO-V24	955AO-V4	955AO-V6	955AO-V8
	955AO-P24	955AO-P4	955AO-P6	955AO-P8
	955AO-FB24	955AO-FB4	955AO-FB6	955AO-FB8
	955AO-W24	955AO-W4	955AO-W6	955AO-W8
955AO-S24	955AO-S4	955AO-S6	955AO-S8	



950P-V6 6' Capri Bench, portable, black diamond rolled pattern, black frame

950 | CAPRI BENCH

- Available in 4', 6', and 8' lengths
- Thermoplastic finish with powder coated frame
- Heavy-duty 2-3/8" O.D. all MIG welded frame
- All stainless steel hardware
- Portable (P), inground (S), or surface mount (SM)
- See page 97 for color options and 96 for seating patterns

4 FOOT	6 FOOT	8 FOOT
950-V4	950-V6	950-V8
950-P4	950-P6	950-P8
950-FB4	950-FB6	950-FB8
950-W4	950-W6	950-W8
950-S4	950-S6	950-S8



963-V6 Contour Bench, portable, blue diamond pattern, black frame

NEW 963 | CONTOUR BENCH

- Available in 4' and 6' lengths
- Thermoplastic finish with powder coated frame
- Heavy-duty 2-3/8" O.D. all MIG welded frame
- All stainless steel hardware
- Portable (P), inground (S), or surface mount (SM)
- See page 97 for color options

4 FOOT	6 FOOT
963-V4	963-V6





955-W6-LL 6' Sierra Bench, red wave pattern, black frame, custom laser lettering



96-S6 6' Jackson Bench, black slat pattern, black frame

96 | JACKSON BENCH WITH BACK

This powder coated bench features a bolt Bolt-Thru design for easy installation and a high end look.

- Available in 4', 6', and 8' lengths
- Powder coated frame and slats
- 1-1/2" square tubing frame
- All stainless steel hardware
- Portable and/or surface mount
- See page 97 for powder coat color options
- Seating pattern: slat only
- See page 46 for matching receptacle

4 FOOT	6 FOOT	8 FOOT
P96-S4	P96-S6	P96-S8



95-S6 6' Jackson Bench, black slat pattern, black frame

95 | JACKSON BENCH WITHOUT BACK

This powder coated bench features a bolt Bolt-Thru design for easy installation and a high end look.

- Available in 4', 6', and 8' lengths
- Powder coated frame and slats
- 1-1/2" square tubing frame
- All stainless steel hardware
- Portable and/or surface mount
- See page 97 for powder coat color options
- Seating pattern: slat only
- See page 46 for matching receptacle

4 FOOT	6 FOOT	8 FOOT
P95-S4	P95-S6	P95-S8



ULTRACOAT

ULTRACOAT COLLECTION
—
TABLES



358-RT 30" Round Table, ultra blue diamond pattern, ultra blue frame



Distributed by: Efficient Amenities



EFFICIENT AMENITIES

Call Us Today.



(855) 884-8387



358H-P-GT 6" Square Table with optional game top, blue perforated pattern, black frame



358-VR 46" Square Table, green diamond rolled pattern, black frame

358 | SQUARE, OCTAGON, & ROUND TABLE

- 46" square, octagon, or round table with 1-9/16" I.D. umbrella hole standard
- Thermoplastic finish with powder coated frame
- 1-5/8" O.D. frame with 1" O.D. brace
- All MIG welded frame with walk-through design
- All stainless steel hardware
- Portable and/or surface mount
- Game top option available (add GT)
- See page 97 for color options and 96 for patterns

SQUARE	SQUARE W/ GAME TOP	OCTAGON	OCTAGON W/ GAME TOP	ROUND	ROUND W/ GAME TOP
358-V	358-V-GT	358-OV	358-OV-GT	358-RDV	358-RDV-GT
358-P	358-P-GT	358-OP	358-OP-GT	358-RDP	358-RDP-GT
358-VR	358-VR-GT	358-OVR	358-OVR-GT	—	—
358-PR	358-PR-GT	358-OPR	358-OPR-GT	—	—

358H | 3-SEAT TABLES

- Open end allows for wheel chair access
- All stainless steel hardware
- Surface mount recommended
- See page 97 for color options and 96 for seating patterns

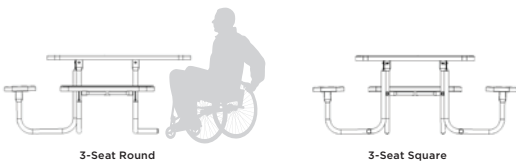

3-Seat Round

3-Seat Square

SQUARE	OCTAGON	ROUND
358H-V	358H-OV	358H-RDV
358H-P	358H-OP	358H-RDP
358H-VR	358H-OVR	—
358H-PR	358H-OPR	—





238-V6 6' Extra Heavy-Duty Rectangular Table, blue diamond pattern, black frame



238-V8 8' Extra Heavy-Duty Rectangular Table, brown diamond pattern, white frame

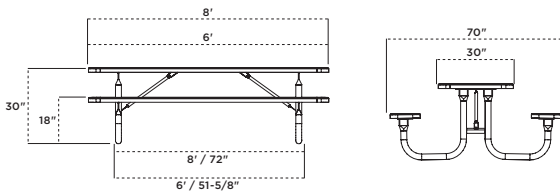

238 | EXTRA HEAVY-DUTY RECTANGULAR TABLE

- 4', 6' and 8' lengths
- Thermoplastic finish with powder coated frame
- 2-3/8" O.D. frame with 1" O.D. brace
- All MIG welded frame with walk-through designs
- All stainless steel hardware
- Portable and/or surface mount
- See page 97 for color options and 96 for patterns

4 FOOT	6 FOOT	8 FOOT
238-V4	238-V6	238-V8
238-P4	238-VR6	238-VR8
—	238-P6	238-P8
—	238-PR6	238-PR8
—	238-FV (frame only)	238-FV (frame only)



238H-V8 8' Double-Sided ADA Accessible Table, red diamond pattern, black frame

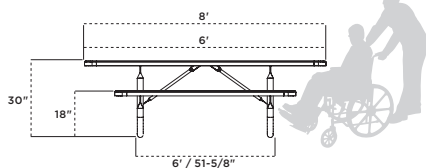

238H | EXTRA HEAVY-DUTY 8' ADA ACCESSIBLE TABLE 

- Available in an 8' ADA Accessible option with choice of single or double-sided accessibility
- Thermoplastic finish with powder coated frame
- 2-3/8" O.D. frame with 1" O.D. brace
- All MIG welded frame with walk-through designs
- All stainless steel hardware
- Portable and/or surface mount
- See page 97 for color options and 96 for patterns

ADA Double-Sided	ADA Single-Sided
238H-V8	238HS-V8
238H-VR8	238HS-VR8
238H-P8	238HS-P8
238H-PR8	238HS-PR8
238H-FV (frame only)	238HS-FV (frame only)





238H-3-V12 12' ADA Shelter Table, portable, red diamond pattern, black frame

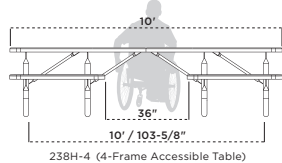
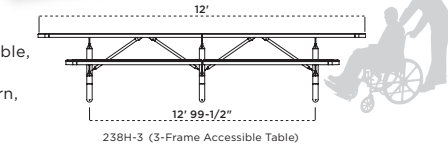

238H | EXTRA HEAVY-DUTY ADA SHELTER TABLE 

- Available in 10' length with 4 frames or 12' length with 3 frames
- ADA accessible
- Thermoplastic finish with powder coated frame
- 2-3/8" O.D. all MIG welded frame
- Features walk-through design
- 1" O.D. brace
- All stainless steel hardware
- Portable and/or surface mount
- See page 97 for color options and 96 for patterns

10 FOOT, 4-FRAME	12 FOOT, 3-FRAME
238H-4-V10	238H-3-V12
238H-4-P10	238H-3-P12
238H-4-FV (frame only)	238H-3-FV (frame only)



238HS-V6 6' Extra Heavy-Duty Single Sided ADA Table, portable, green diamond pattern, black frame

NEW 238HS | EXTRA HEAVY-DUTY SINGLE SIDED ADA TABLE 

- Available in 6' length
- ADA accessible
- Thermoplastic finish with powder coated frame
- 2-3/8" O.D. all MIG welded frame
- Features walk-through design
- 1" O.D. brace
- All stainless steel hardware
- Surface mount only
- See page 97 for color options and 96 for patterns

6 FOOT	8 FOOT
238HS-P6	238HS-V8
238HS-V6	238HS-VR8
—	238HS-P8
—	238HS-PR8
—	238HS-FV (frame only)



238-3-V10 10' Shelter Table, brown diamond pattern, black frame

238-3 | EXTRA HEAVY-DUTY SHELTER TABLE

- Available in 10' or 12' lengths with 3 frames
- Thermoplastic finish with powder coated frame
- 2-3/8" O.D. frame with 1" O.D. brace
- All MIG welded frame with walk-through designs
- All stainless steel hardware
- Portable and/or surface mount
- Includes 2 sections and 3 legs for added support
- See page 97 for color options and 96 for patterns

10 FOOT, 3-FRAME	12 FOOT, 3-FRAME
238-3-V10	238-3-V12
238-3-P10	238-3-P12
238-3-FV (frame only)	238-3-FV (frame only)



TABLES



158-P8 8' Heavy-Duty Rectangular Table, black perforated pattern, black frame

158 | HEAVY-DUTY RECTANGULAR TABLE

- 4', 6', and 8' lengths with walk-through design
- Thermoplastic finish with powder coated frame
- 1-5/8" O.D. all MIG welded frame
- 1" O.D. brace
- All stainless steel hardware
- Portable and/or surface mount
- See page 97 for color options and 96 for patterns

4 FOOT	6 FOOT	8 FOOT
158-V4	158-V6	158-V8
158-P4	158-VR6	158-VR8
—	158-P6	158-P8
—	158-PR6	158-PR8
—	158-FV (frame only)	158-FV (frame only)



158H-V8 8' Heavy-Duty Rectangular Table, red diamond pattern, black frame

158H | HEAVY-DUTY 8' ADA ACCESSIBLE TABLE 

- Available in an 8' ADA accessible option with choice of single or double-sided handicap accessibility
- Thermoplastic finish with powder coated frame
- 1-5/8" O.D. all MIG welded frame
- 1" O.D. brace
- All stainless steel hardware
- Portable and/or surface mount
- See page 97 for color options and 96 for patterns

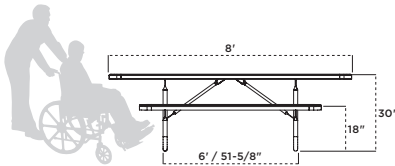

ADA DOUBLE SIDED	ADA SINGLE SIDED
158H-V8	158HS-V8
158H-VR8	158HS-VR8
158H-P8	158HS-P8
158-PR8	158HS-PR8
158-FV (frame only)	158-FV (frame only)



BT158-V6 6' Heavy-Duty Bolt-Thru Rectangular Table, green diamond pattern, black frame

BT158 | HEAVY-DUTY BOLT-THRU TABLE

- Available in 6' and 8' lengths
- Thermoplastic finish with powder coated frame
- 1-5/8" O.D. bolt together frame
- 1" O.D. brace
- All stainless steel hardware
- Portable and/or surface mount
- See page 97 for color options and 96 for patterns

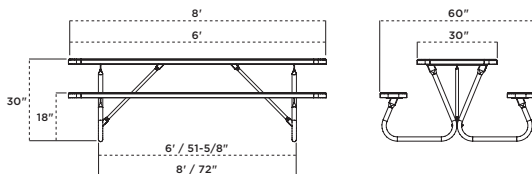

6 FOOT	8 FOOT
BT158-V6	BT158-V8
BT158-VR6	BT158-VR8
BT158-P6	BT158-P8
BT158-PR6	BT158-PR8
BT158-FV (frame only)	BT158-FV (frame only)





230-RDPC-46 46" Round Contour Table, brown perforated pattern, brown frame



BT238-V6 6' Extra Heavy-Duty Bolt-thru Rectangular Table, green diamond pattern, black frame

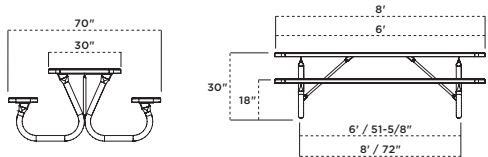

BT238 | EXTRAHEAVY-DUTY BOLT-THRU

- Available in 6' and 8' lengths
- Thermoplastic finish with powder coated frame
- 2-3/8" O.D. all bolt together walk-through frame
- 1" O.D. brace
- All stainless steel hardware
- Portable and/or surface mount
- See page 97 for color options and 96 for patterns

6 FOOT	8 FOOT
BT238-V6	BT238-V8
BT238-VR6	BT238-VR8
BT238-P6	BT238-P8
BT238-PR6	BT238-PR8
BT238-FV (frame only)	BT238-FV (frame only)



230-RDPC-46 46" Round Contour Table, brown perforated pattern, brown frame

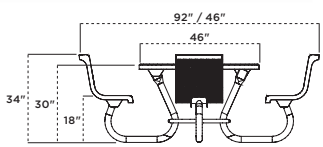

230 | ROUND CONTOUR TABLE

- 46" table top with a standard 1-9/16" dia. umbrella hole
- Thermoplastic finish with powder coated frame
- 2-3/8" O.D. all bolt together walk-through frame
- All stainless steel hardware
- Portable and/or surface mount
- See page 97 for color options and 96 for patterns

46" TABLE	46" 3-SEAT TABLE
230-RDVC46	230H-RDVC46
230-RDPC46	230H-RDPC46





238H-V8 8' Extra Heavy-Duty Bolt-Thru Rectangular Table, green diamond pattern, black frame



337SM-P6 6' Heavy-Duty Rectangular Single Pedestal Table, surface mount, brown perforated pattern, black frame

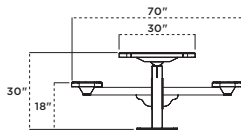

337 | HEAVY-DUTY RECTANGULAR SINGLE PEDESTAL TABLE 

- Available in 4' and 6' lengths with ADA accessibility
- Thermoplastic finish with powder coated frame
- 4" x 4" square post frame with 3" x 3" square support arms
- All MIG welded frame
- All stainless steel hardware
- Inground (S) or surface mount (SM)
- See page 97 for color options and 96 for patterns

4 FOOT	6 FOOT
337-V4	337-V6
337-P4	337-VR6
—	337-P6
—	337-PR6



349S-V6 6' Multi Pedestal Table, inground, ultra blue diamond pattern, black frame

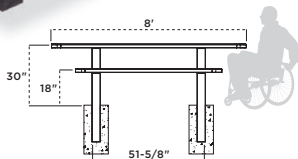

349 | MULTI PEDESTAL TABLE 

- Available in 6', and 8' lengths with ADA accessibility (8' only)
- Thermoplastic finish with powder coated frame
- 4" square post all MIG welded frame with walk-through design
- All stainless steel hardware
- Inground (S) or surface mount (SM)
- See page 97 for color options and 96 for patterns

6 FOOT	8 FOOT	ADA 8 FOOT
349-V6	349-V8	349H-V8
349-P6	349-P8	349H-P8
349-VR6	349-VR8	349H-VR8
349-PR6	349-PR8	349H-PR8





347-P6 6' Rectangular Dual Pedestal Table, green perforated pattern, black frame

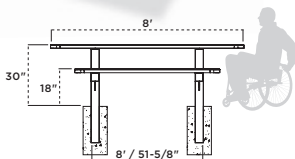

347 | RECTANGULAR DUAL PEDESTAL

- Available in 6' and 8' lengths with ADA accessibility (8' only)
- Thermoplastic top and seats with powder coated frame
- 4" x 4" square all MIG welded frame and support arms
- All stainless steel hardware
- Inground (S) or surface mount (SM)
- See page 97 for color options and 96 for patterns

6 FOOT	8 FOOT	ADA 8 FOOT
347-V6	347-V8	347H-V8
347-P6	347-P8	347H-P8
347-VR6	347-VR8	347H-VR8
347-PR6	347-PR8	347H-PR8



238U-V6 6' Utility Table, portable, red diamond pattern, black frame

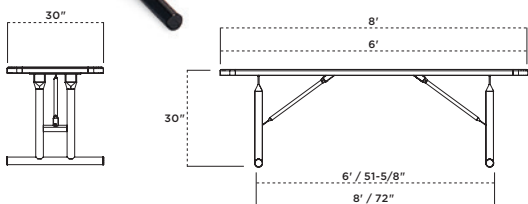

238U | UTILITY TABLE

Utility Tables have an easy access design and are ideal for any park or restaurant.

- Available in 6' and 8' lengths with ADA accessibility
- Thermoplastic finish with powder coated frame
- 2-3/8" O.D. all MIG welded frame
- 1" O.D. brace
- All stainless steel hardware
- Portable only
- See page 97 for color options and 96 for patterns

6 FOOT	8 FOOT
238U-V6	238U-V8
238U-VR6	238U-VR8
238U-P6	238U-P8
238U-PR6	238U-PR8



349SU-V8 8' Utility Table, inground mount, blue diamond pattern, black frame

349SU | MULTI PEDESTAL UTILITY TABLE

Utility Tables have an easy access design and are ideal for any park or restaurant.

- Available in 6' and 8' lengths with ADA accessibility
- Thermoplastic finish with powder coated frame
- 4" square post all MIG welded frame with walk-through design
- All stainless steel hardware
- Inground (S) or surface mount (SM)
- See page 97 for color options and 96 for patterns

6 FOOT	8 FOOT
349SU-V6	349SU-V8
349SU-VR6	349SU-VR8
349SU-P6	349SU-P8
349SU-PR6	349SU-PR8





358-P-GT 46" Square Table with optional game top, blue perforated pattern, black frame



239SM-V 8' Rectangle UltraSite® Span Leg Table, green diamond pattern, black frame

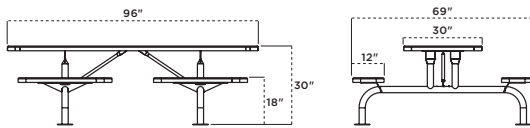

239 | RECTANGULAR ULTRASITE® SPAN LEG TABLE

- Span Leg design allows additional legroom and easy clean-up access, ideal for outdoor eating areas
- Available in 8' only
- Thermoplastic finish with powder coated frame
- Frame is made of 2 3/8" O.D. powder coated steel tubing
- All MIG welded frame
- Inground (S) or surface mount (SM)
- Cover plates are available in sets of 2, sold separately
- Pattern options: perforated, diamond
- See page 97 for color options

RECTANGLE TABLE

- 239-V
- 239-P



369SM-V Square UltraSite® Span Leg Table, black diamond pattern, black frame

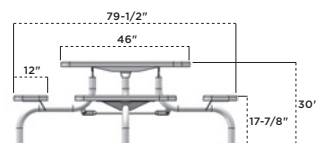

369 | SQUARE SPAN LEG TABLE

- Span Leg design allows additional legroom and easy clean-up access, ideal for outdoor eating areas
- Frame is made of 2 3/8" O.D. powder coated steel tubing
- Thermoplastic finish with powder coated frame
- All MIG welded frame
- Inground (S) or surface mount (SM)
- ADA accessible option available
- Cover plates are available in sets of 2, sold separately
- Pattern options: perforated, diamond
- Available in square, round, or octagon shapes
- See page 97 for color options

ROUND TABLE	OCTAGON TABLE	SQUARE TABLE	3-SEAT SQUARE TABLE
369-RDV	369-OV	369-V	369H-V
369-RDP	369-OP	369-P	369H-P





501S-P 1 Seat Canteen Table, red perforated pattern, red frame
 504S-P 4 Seat Canteen Table, red perforated pattern, red frame



501S-P Canteen Table, red perforated pattern, red frame

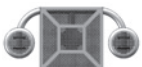

2 SEAT

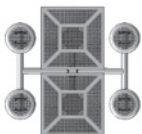

4 SEAT

501 | CANTEEN TABLE

- Single pedestal design allows for easy clean-up access, ideal for outdoor eating areas
- Available in multiple sizes with 1, 2, and 4-seat options
- Thermoplastic finish with powder coated frame
- Inground (S) or surface mount (SM)
- Pattern: perforated only
- See page 97 for color options

1 SEAT	2 SEAT	4 SEAT
501-P	502-P	504-P



358-VC 46" Square Capri Seating Table, green diamond pattern, green frame

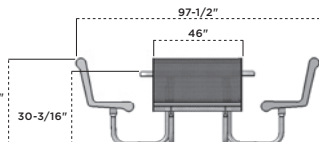

358 | CAPRI SEATING TABLE

- 46" square or octagon table top with a standard 1-9/16" dia. umbrella hole
- Thermoplastic finish with powder coated frame
- 1-5/8" O.D. all MIG welded frame with walk-through design
- All stainless steel hardware
- Portable and/or surface mount
- Seating pattern options: perforated, diamond
- See page 97 for color options

SQUARE	OCTAGON	SQUARE 3-SEAT
358-VC	358-OVC	358H-VC
358-PC	358-OPC	358H-PC





320-P6 6' Canopy Table, inground, ultra blue perforated pattern, black frame



320-P6 6' Canopy Table, inground, ultra blue perforated pattern, black frame

320/321 | CANOPY TABLE

- 6' lengths available with canopy
- Thermoplastic finish with powder coated frame
- 4" x 4" square all MIG welded frame and support arms
- Canopy offers protection from the sun
- All stainless steel hardware
- Inground mount only
- Pattern options: perforated, diamond
- See page 97 for color options

TABLE (320)	BENCH (321)
320-V6	321-V6
320-P6	321-P6

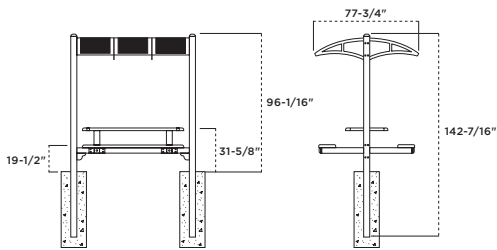
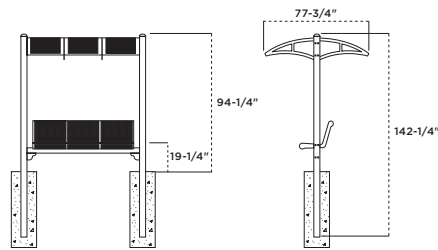

TABLE (320)



BENCH (321)





338S-RDV 46" Round Single Pedestal Table, inground mount, red diamond pattern, black frame shown with PR-32-LL Custom, Metal Trash Receptacle, red perforated pattern with RBR-32-08 rain bonnet lid and PL-32 plastic liner.



338 | 46" SINGLE PEDESTAL TABLE 

- 46" square, octagon, or round top table with standard 1-9/16" I.D. umbrella hole
- Thermoplastic finish with powder coated frame
- 4" x 4" square post frame with 2-7/8" O.D. round support arms
- All stainless steel hardware
- Inground (S) or surface mount (SM)
- ADA accessible option available
- See page 97 for color options and 96 for patterns

338SM-RDV 46" Round Single Pedestal Table, surface mount, red diamond pattern, black frame

SQUARE	OCTAGON	ROUND	ADA DOUBLE-SIDED	ADA SINGLE-SIDED
338-V	338-OV	338-RDV	338H2-add (H2)	338H3-add (H3)
338-P	338-OP	338-RDP		
338-VR	338-OVR			
338-PR	338-OPR			

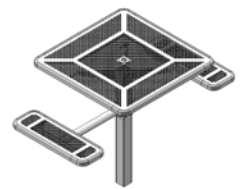

338H2

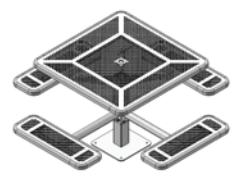

338SM-P





361L-V Portable Square Low Food Court Table, green diamond pattern, black frame with 953-V Low Food Court Chairs, green diamond pattern, black frame



360P-RDSD Round Tall Food Court Table, portable, green solid top, black frame

360/360L | PEDESTAL FOOD COURT TABLE

- 36" table top with 42" high frame or optional low (L) 30" frame
- Thermoplastic finish with powder coated frame
- 3-1/2" O.D. all MIG welded – portable (P)
- 3" Square all MIG welded – inground (S) or surface mount (SM)
- All stainless steel hardware
- Portable (P), Inground (S), or surface mount (SM)
- Can be used with the 956/953 food court chairs
- Umbrella hole not available
- See page 97 for color options and 96 for patterns

42" TALL	SQUARE	ROUND	30" LOW	SQUARE	ROUND
	360-V	360-RDV		360L-V	360L-RDV
	360-P	360-RDP		360L-P	360L-RDP
	360-SD	360-RDSD		360L-SD	360L-RDSD



361L-RDV Low Round Food Court Table, portable, green diamond pattern, black frame

361 | FOOD COURT TABLE

- 36" table top with 42" high frame or optional low (L) 30" frame
- 1-9/16" diameter umbrella hole
- Thermoplastic finish with powder coated frame
- 1-5/8" O.D. all MIG welded (portable)
- All stainless steel hardware
- Portable only
- Can be used with the 956/953 food court chairs
- Pattern options: perforated, diamond
- See page 97 for color options

42" TALL	SQUARE	ROUND	30" LOW	SQUARE	ROUND
	361-V	361-RDV		361L-V	361L-RDV
	361-P	361-RDP		361L-P	361L-RDP
	361-SD	361-RDSD		361L-SD	361L-RDSD





956-V Tall Food Court Chairs, green diamond pattern, green frame

956 | TALL FOOD COURT CHAIRS

- 30" chair with 18" wide contour seat
- Thermoplastic finish with powder coated frame
- 1-5/16" O.D. all MIG welded
- All stainless steel hardware
- Portable only
- Can be used with the 42" tall 360/361 tables
- See page 97 for color options and 96 for patterns

30" CHAIR

- 956-V
- 956-P
- 956-FB
- 956-W
- 956-S



953-V Low Food Court Chair, green diamond pattern, black frame

953 | STANDARD FOOD COURT CHAIRS

- 18" contour seat
- Thermoplastic finish with powder coated frame
- 1-5/16" O.D. all MIG welded arched support legs and arms
- All stainless steel hardware
- Portable only
- Can be used with the 30" tall 360L/361L tables
- See page 97 for color options and 96 for patterns

18" CHAIR

- 953-V
- 953-P
- 953-FB
- 953-W
- 953-S



362SM-RDV 46" Ultra Bar Height Table, surface mount, ultra blue diamond pattern, ultra blue frame

362 | ULTRA BAR HEIGHT TABLE

- 46" table top with a standard 1-9/16" diameter umbrella hole
- Thermoplastic finish with powder coated frame
- 2-3/8" O.D. all MIG welded frame
- Cover plates available
- All stainless steel hardware
- Inground (S) or Surface Mount (SM)
- Pattern options: perforated, diamond
- See page 97 for color options

46" ROUND TABLE

- 362-RDV
- 362-RDP

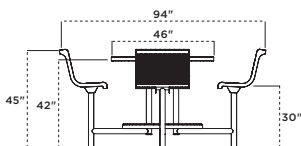

ULTRACOAT

ULTRACOAT & PREMIUM COLLECTION
—
RECEPTACLES



41-SD Kingston Receptacle, vertical slat, blue vein



Distributed by: Efficient Amenities



EFFICIENT AMENITIES

Call Us Today.



(855) 884-8387



41-SD Kensington Receptacle, vertical slat, black

41-SD | KENSINGTON RECEPTACLE

The Kensington receptacle features a side loading opening and a solid top.

- 36 gallon capacity
- Only available in powder coated finish
- 1-1/2" x 1/4" flat steel strips
- All MIG welded frame
- Portable and/or surface mount
- Lid and liner included
- See page 97 for color options



AG-36FT Augusta Receptacle, vertical slat, flat top lid, spartan bronze

AG-36 | AUGUSTA RECEPTACLE

- 36 gallon capacity
- Only available in powder coated finish
- 1-1/2" x 1/4" flat steel strips
- Top and bottom rings are 1" pipe
- All MIG welded frame
- Portable and/or surface mount
- Lid and liner included
- See page 97 for color options

FLAT TOP	ASH URN	RAIN BONNET
AG-36FT	AG-36AU	AG-36RB



51-HX Huntington Receptacle, flat top lid, spartan bronze frame with burgundy backing

51-HX | HUNTINGTON RECEPTACLE

- 32 gallon capacity
- Only available in powder coated finish
- Inner shield can be powder coated in a different color
- 1" square steel tubing
- Top and bottom rings are 1-1/2" square steel tubing
- All MIG welded
- Portable and/or surface mount
- Lid and liner included
- See page 97 for color options

FLAT TOP	ASH URN	RAIN BONNET
51-HXFT	51-HXAU	51-HXRB





LX-36RB Lexington Receptacle, vertical slat, spartan bronze with matching rain bonnet lid



LX-36FT Lexington Trash Receptacle, vertical slat, beige with matching flat top lid

LX-36 | LEXINGTON RECEPTACLE

- 36 gallon capacity
- Only available in powder coated finish
- 1/8" x 2" steel flat bar
- All MIG welded frame
- Portable and/or surface mount
- Lid and liner included
- See page 97 for color options

FLAT TOP	ASH URN	RAIN BONNET
LX-36FT	LX-36AU	LX-36RB

Add a decal to most lids to give a receptacle the versatility of being both a trash receptacle and recycling receptacle.



LX-72 Dual Lexington Trash Receptacle, vertical slat, black with (2) matching flat top lids with decal option

LX-72 | DUAL LEXINGTON RECEPTACLE

- Holds 2 32 gallon liners and 2 powder coated lids
- Only available in powder coated finish
- 1/8" x 2" steel flat bar
- Zinc plated hardware
- Optional decals are white lettering with black background
- Decals installed onsite
- Portable and/or surface mount
- Lids and liners included
- See page 97 for color options

FLAT TOP	ASH URN	RAIN BONNET
LX-72-FT	LX72-AU	LX-72-RB

DECAL OPTIONS			
"CANS"	"PLASTICS"	"TRASH"	"RECYCLE"
01-05-0136	01-05-0137	01-05-0135	01-05-0130





OX-36FT Oxford Receptacle, ultra blue vertical slat with flat top lid



OX-36FT Oxford Receptacle, ultra blue vertical slat with matching flat top lid

NEW OX-36 | OXFORD RECEPTACLE

- 36 gallon capacity
- Thermoplastic finish
- Slat design with flared top
- All MIG welded
- Lid and liner included

FLAT TOP	ASH URN	RAIN BONNET
OX-36FT	OX-36AU	OX-36RB

CL-36 | CLASSIC SWING DOOR RECEPTACLE

- 1/4" x 1-1/2" steel flat bar
- All MIG welded frame
- Only available in powder coated finish
- All stainless steel hardware
- Portable and/or surface mount
- Lid and liner included



CL-36 Classic Swing Door Receptacle, vertical slat, black with matching flat top lid

FLAT TOP LID	ASH URN LID	RAIN BONNET LID
CL-36FT	CL-36AU	CL-36RB





PR-32 Metal Trash Receptacle, blue perforated pattern with RT-32 Round Top Lid and PL-32 Liner



JK-36FT Jackson Receptacle, green vertical slat with matching flat top lid

JK-36 | JACKSON RECEPTACLE

- 36 gallon capacity
- Only available in powder coated finish
- 1/8" x 2" steel flat bar
- All MIG welded frame
- Portable and/or surface mount
- Lid and liner included
- See page 97 for color options

FLAT TOP	ASH URN	RAIN BONNET
JK-36FT	JK-36AU	JK-36RB



SD-36FT Swing Door Receptacle, vertical slat, blue with matching flat top lid

NEW SD-36FT | SWING DOOR RECEPTACLE

- 36 gallon capacity
- Thermoplastic finish
- Slat design with flared top
- All MIG welded unit
- Lid and liner included
- Featuring easy access swing door
- Portable and/or surface mount

FLAT TOP	ASH URN	RAIN BONNET
SD-36FT	SD-36AU	SD-36RB





EX-32 Metal Trash Receptacle, blue diamond pattern with **FTR-32-08** Flat Top Lid and **PL-32** Liner

W-32 Metal Trash Receptacle, red wave pattern with **RT-32** Round Dome-Top Lid and **PL-32** Liner

METAL TRASH RECEPTACLES

- Available in 32 gallon and 55 gallon capacities
- Thermoplastic finish
- All MIG welded unit
- Portable with mounting kit sold separately
- Lids and liners are sold separately
- See page 48 for lids and liners
- See page 97 for color options and 96 for patterns

32 GALLON	55 GALLON
EX-32	EX-55
PR-32	PR-55
FB-32	FB-55
W-32	W-55
S-32	S-55



PR-32RE Standard Recycled Logo Receptacle, ultra blue perforated pattern with **FTR-32-08** Flat Top Lid and **PL-32** Liner

32RE | STANDARD RECYCLE LOGO RECEPTACLE

- 32 gallon capacity
- Thermoplastic finish
- All MIG welded unit
- Portable with mounting kit sold separately
- Lid and liner sold separately
- Three recycling emblems to be visible from all angles
- See page 48 for lids and liners
- Diamond (EX) and perforated (PR) patterns only
- See page 97 for color options

32 GALLON
PR-32RE
EX-32RE



You can customize most receptacles.
See page 51 for more information.

PR-32-CL Custom Metal Trash Receptacle, perforated pattern, black with optional color backing, **RBR-32-08** Rain Bonnet Lid and **PL-32** Liner



SM KIT Surface Mounting Kit



IG KIT Inground Mounting Kit

RECEPTACLE MOUNTING KITS

All trash receptacles are portable and can be converted into either inground (IG) or surface mount (SM). Kits fit 32, 36 (IG only), and 55 gallon receptacles. Sold separately

- 2-3/8" O.D. all MIG welded pipe
- Powder coated black finish

SIZE	INGROUND	SURFACE
32 GAL	IG KIT	SM KIT
36 GAL	IG KIT	--
55 GAL	IG KIT	SM KIT



RECEPTACLES

METAL RECEPTACLE LIDS

- Fit our 32 or 55 gallon receptacles
- 8" opening (08) standard
- Optional 14" opening (14) available
- 23-3/4" I.D. opening (32 gallon tops)
- 1/2" diameter rod (AUR & RBR)
- All MIG welded frame (AUR & RBR)

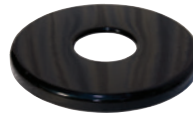

FTR-32-08

FTR | FLAT TOP

- 24"w (26³/₄" for 55 gal.)
- Spun metal lid
- Thermoplastic lids required on thermoplastic receptacles
- Powder coated lids required on recycled plastic receptacles
- See page 97 for color options

SIZE	8" OPENING	14" OPENING
32 GAL	FTR-32-08	FTR-32-14
55 GAL	FTR-55-08	FTR-55-14

RT-32 | ROUND TOP



RT-32

- 11³/₄"h x 24 7/8"w
- 32 gallon 24" I.D.
- Heavy duty polyethylene w/ swing door
- Only available on thermoplastic receptacles
- Comes standard as black (also available in Brown, Gray, or Blue)

32 GAL	RT-32
--------	-------

DT-32 | DOME TOP



DT-32

- 17"h x 24³/₈"w for 32 gal.
- 18"h x 28¹/₄"w for 55 gal.
- 32 gal. 24" I.D. and 55 gal. 27" I.D.
- Heavy duty polyethylene w/ swing door
- Only available on thermoplastic receptacles
- Black only

32 GAL	DT-32	55 GAL	DT-55
--------	-------	--------	-------



AUR-32-08

AUR | ASH URN

- 13"h x 24"w (26³/₄" for 55 gal.)
- 20 gauge spun metal bonnet and ash urn
- Thermoplastic lids required on thermoplastic receptacles
- Powder coated lids required on recycled plastic receptacles
- See page 97 for color options

SIZE	8" OPENING	14" OPENING
32 GAL	AUR-32-08	AUR-32-14
55 GAL	AUR-55-08	AUR-55-14

RBR | RAIN BONNET



RBR-32-08

- 13"h x 24"w (26³/₄" for 55 gal.)
- 20 gauge spun metal bonnet
- Thermoplastic lids required on thermoplastic receptacles
- Powder coated lids required on recycled plastic receptacles
- See page 97 for color options

SIZE	8" OPENING	14" OPENING
32 GAL	RBR-32-08	RBR-32-14
55 GAL	RBR-55-08	RBR-55-14

See page 47 for receptacle mounting kits



PL | RECEPTACLE LINER

- Liner fits most of our 32 and 55 gallon trash receptacles.
- 32-Gallon measures 21-7/8" wide x 27-1/2" tall
- 55-Gallon measures 23-3/8" wide x 31-3/8" tall
- Heavy-Duty Plastic
- Sold separately unless noted

32 GALLON	55 GALLON
PL-32	PL-55



CABLE | 18" CABLE

Cable is sold separately. **Specify cable when ordering lid and receptacle**

- Attachment is used to keep the lid and trash receptacle permanently connected
- 3/32" diameter braided cable



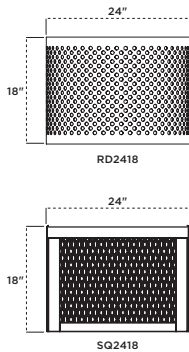

RD2418-P Round Planter, black perforated pattern

RD2418/SQ2418 | PLANTER

- 24" wide x 18" high planters
- Thermoplastic finish
- All MIG welded frame
- Diamond (V) or Perforated (P) design
- Portable and/or surface mount
- 01-05-0212 liner sold separately
- See page 97 for color options

SQUARE	ROUND
SQ2418-V	RD2418-V
SQ2418-P	RD2418-P



RD2418-LX Lexington Planter, brown vertical slat pattern

RD2418-LX | LEXINGTON PLANTER

- 24" wide x 18" high planters
- Powder coated finish
- 1/8" x 2" steel flat bar
- All MIG welded frame
- Portable and/or surface mount
- Inground mounting kit available - sold separately
- 01-05-0212 liner sold separately
- See page 97 for color options



PR-12AT Trash Combo, green perforated pattern

12/12AT | ASH TRAY & ASH TRAY/TRASH COMBO

- 12 Series Ash Tray and 12AT Ash Tray/Trash combination.
- 12-1/2" wide x 24" high
- All MIG welded
- Portable and/or surface mount
- Liner included with EX-12 and PR-12 only
- See page 97 for color options

STYLE	ASH TRAY	ASH TRAY/ TRASH COMBO
Diamond Pattern	EX-12	EX-12AT
Perforated Pattern	PR-12	PR-12AT



ULTRACOAT

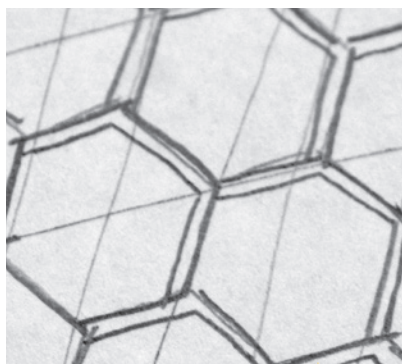
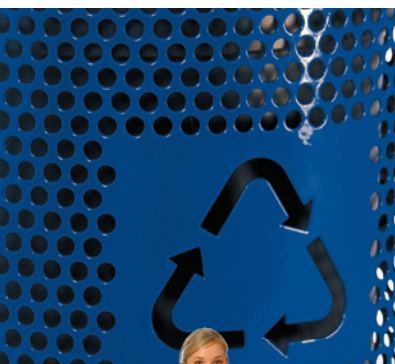
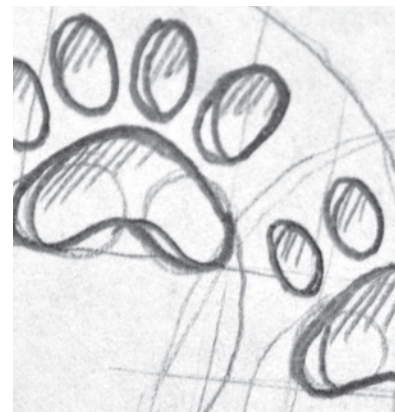
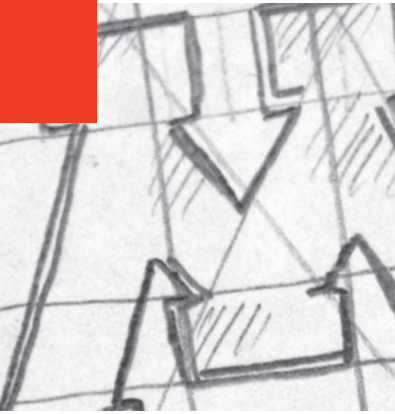
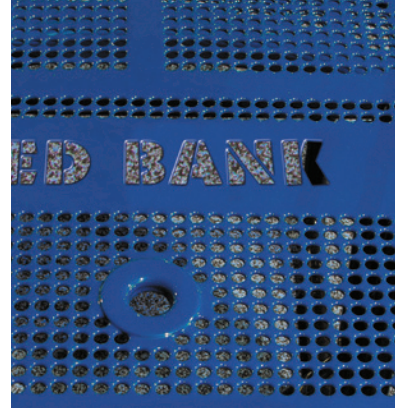

Distributed by: Efficient Amenities



EFFICIENT AMENITIES

Call Us Today.



(855) 884-8387

LOGOS & LETTERING

Include your logo, emblem, or insignia on most UltraSite® classic furnishings.

- Smooth cut edges
- Artwork is converted to an exact replica
- Customized typeface and style
- 2D proof provided for approval

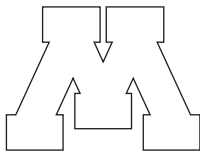
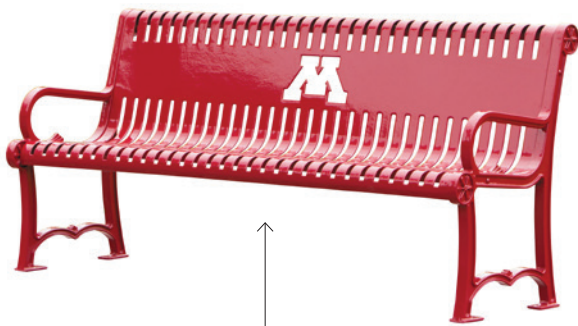
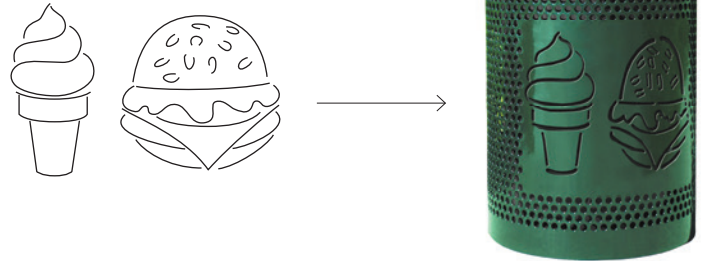

BLUFF CITY



PR-55-CL Custom Metal Trash Receptacle, black perforated pattern with optional ultra silver backing, shown with FTR-55-08 Flat Top Lid, and PL-55 Liner





BUDDY BENCH BUILDER

CREATE YOUR VERY OWN CUSTOM BUDDY BENCH FOLLOWING OUR EASY 4 STEP PROCESS.

please give us a call if you have any questions and a customer service representative will be happy to assist you. 800-458-5872

1

CHOOSE YOUR BUDDY BENCH



940P-P6-BB 6' Buddy Bench, portable, blue diamond pattern, black frame

940 | BUDDY BENCH

- Available in 6' or 8'
- Diamond or Perforated Pattern
- Portable (P), inground (S), or surface mount (SM)
- Thermoplastic finish (on seat and back) with powder coated frame
- 1" O.D. Brace (portable frame only)

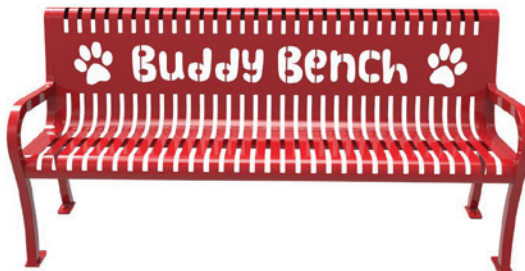

954-CL 6' Lexington Buddy Bench, red slat pattern

954 | LEXINGTON BUDDY BENCH

- Available in 4', 6', or 8'
- Slat pattern
- Portable and/or surface mount
- 1-1/2" thick cast aluminum frame
- Thermoplastic finish



2

CHOOSE YOUR LETTERING

*Don't see what you're looking for?
Call us for a custom quote!*

A. Buddy Bench

D. BUDDY BENCH

B. BUDDY BENCH

E. Buddy Bench

C. Buddy Bench

F. Buddy Bench

3

CHOOSE YOUR ICON



SUN



TREE



BALLOONS



FRIENDS



PAW PRINT

4

CHOOSE YOUR COLOR



ULTRA BLUE



BURGUNDY



GREEN



BEIGE



BLUE



RED



BROWN



BLACK

ULTRACOAT® THERMOPLASTIC COLORS

- Superior Adhesion
- Resistance to Cutting and Vandalism
- No Runs or Drips
- Smooth Finish Prevents Mold and Mildew
- Easily Repaired
- UV Protection
- Environmentally Friendly



ULTRA BLUE



BURGUNDY



GREEN



BEIGE



BLUE



RED



BROWN



BLACK



YELLOW



PURPLE



DARK GREY



MATTE BLACK



WHITE

STANDARD POWDER COAT COLORS

The steel framework used in the UltraCoat® product line delivers one of the industry's most durable protective coatings. UltraSite® further enhances the durability by applying a superior powder coated finish. The process provides five layers of protection from harmful environmental elements, with very little maintenance.





940PPS-V3 3' Portable Preschool Bench, red diamond pattern, black frame

940PPS | 3' PORTABLE PRESCHOOL BENCH

- 3' length with 12" high seating
- Thermoplastic finish and powder coated frame
- 1-5/8" O.D. all MIG welded pipe
- 1" O.D. brace (portable frame only)
- All stainless steel hardware
- Portable (P) or inground (S)
- See page 97 for color options and 96 for seating patterns

PRESCHOOL

940PPS-V3

940PPS-P3

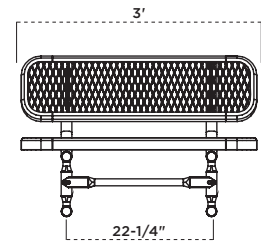
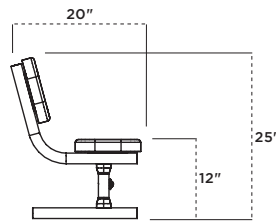

158PS-V6 6' Rectangular Preschool Table, green diamond pattern, black frame

158PS | RECTANGULAR PRESCHOOL TABLE

- Available in 4', 6', and 8' lengths with 20" high top and 12" high seating
- Thermoplastic finish with powder coated frame
- 1-5/8" O.D. all MIG welded pipe with 1" O.D. brace
- Walk through design
- All stainless steel hardware
- Portable
- See page 97 for color options and 96 for patterns

4 FOOT

158PS-V4

158PS-P4

6 FOOT

158PS-V6

158PS-P6

8 FOOT

158PS-V8

158PS-P8

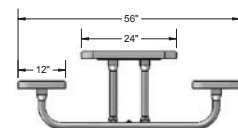



358PS-PLP Learning Table with Perforated Pattern



350PS-P Preschool Table with solid table top design and perforated seating

350PS | PORTABLE PRESCHOOL TABLE

- 46" table top and 20" high seating
- 1-5/8" O.D. all MIG welded pipe with 1" O.D. brace
- Walk through design
- All stainless steel hardware
- Also available with custom decal

46" TABLE	SQUARE Solid Top	SQUARE Solid Top with Custom Decal
	350PS-P	350PS-P-DL
	350PS-V	350PS-V-DL



358PS-PLP Learning Table, perforated pattern

358PS | PORTABLE PRESCHOOL TABLE

- 46" table top and 20" high seating
- 1-5/8" O.D. all MIG welded pipe with 1" O.D. brace
- Walk through design
- All stainless steel hardware
- Also available with learning table top that includes alphabet and numbers 0-9 to compliment your early childhood setting

46" TABLE	SQUARE	OCTAGON	ROUND	LEARNING TABLE
	358PS-P	358PS-OP	358PS-RDP	358PS-PLP
	358PS-V	358PS-OV	358PS-RDV	
	358PS-VR	358PS-OVR		
	358PS-PR	358PS-OPR		

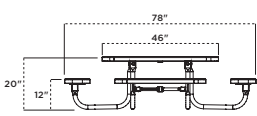
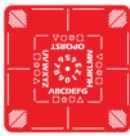

NATURAL COLLECTION



100% Recycled Plastic Planks

982S-46 6' Recycled Bench with Back, inground mount, 3" x 4" custom blue recycled planks, blue frame
*Contact us for more information about custom colors



Distributed by: Efficient Amenities



EFFICIENT AMENITIES

Call Us Today.



(855) 884-8387



968-CDR6 6' Charleston Recycled Bench without back, cedar recycled plastic planks, black frame

968 | CHARLESTON RECYCLED BENCH WITHOUT BACK

- 6' and 8' lengths
- Recycled planks with thermoplastic finish on frame
- 1-1/2" thick cast aluminum frame
- All stainless steel hardware
- Portable and/or surface mount
- See page 95 for plank color options

6 FOOT	8 FOOT
968-GRY6	968-GRY8
968-CDR6	968-CDR8
968-BRN6	968-BRN8
968-GRN6	968-GRN8



964-BRN6 6' Charleston Recycled Bench, brown recycled plastic planks, black frame

964 | CHARLESTON RECYCLED BENCH WITH BACK

- 6' and 8' lengths
- Recycled planks with thermoplastic finish on frame
- 1-1/2" thick cast aluminum frame
- All stainless steel hardware
- Portable and/or surface mount
- See page 95 for plank color options

6 FOOT	8 FOOT
964-GRY6	964-GRY8
964-CDR6	964-CDR8
964-BRN6	964-BRN8
964-GRN6	964-GRN8



982SM-GRN46 6' Recycled Bench with Back, surface mount, 4" x 4" green recycled plastic planks, black frame

982 | RECYCLED BENCH WITH BACK

- Available in 6' or 8' lengths
- Available with 2" x 4", 3" x 4", or 4" x 4" recycled plastic planks with powder coated finish on frame
- 3" x 3" square all MIG welded frame
- All zinc plated hardware
- Surface mount (SM) or inground mount (S)
- See page 95 for plank color options

6 FOOT	2" x 4" <input type="checkbox"/>	3" x 4" <input type="checkbox"/>	4" x 4" <input type="checkbox"/>
	982-GRY6	982-GRY36	982-GRY46
	982-CDR6	982-CDR36	982-CDR46
	982-BRN6	982-BRN36	982-BRN46
	982-GRN6	982-GRN36	982-GRN46

8 FOOT	2" x 4" <input type="checkbox"/>	3" x 4" <input type="checkbox"/>	4" x 4" <input type="checkbox"/>
	982-GRY8	982-GRY38	982-GRY48
	982-CDR8	982-CDR38	982-CDR48
	982-BRN8	982-BRN38	982-BRN48
	982-GRN8	982-GRN38	982-GRN48



BENCHES



952SM-GRN46 6' Recycled Bench without Back, surface mount, 4" x 4" green recycled plastic planks, black frame

952 | RECYCLED BENCH WITHOUT BACK

- Available in 6' or 8' lengths
- Available with 2" x 4", 3" x 4", or 4" x 4" recycled plastic planks with powder coated or hot-dip galvanized frame
- 3" x 3" square all MIG welded frame
- All zinc plated hardware
- Surface mount (SM) or inground mount (S)
- See page 97 for frame color options and 95 for plank color options

6 FOOT	2" x 4"	3" x 4"	4" x 4"
	952-GRY6	952-GRY36	952-GRY46
952-CDR6	952-CDR36	952-CDR46	
952-BRN6	952-BRN36	952-BRN46	
952-GRN6	952-GRN36	952-GRN46	

8 FOOT	2" x 4"	3" x 4"	4" x 4"
	952-GRY8	952-GRY38	952-GRY48
952-CDR8	952-CDR38	952-CDR48	
952-BRN8	952-BRN38	952-BRN48	
952-GRN8	952-GRN38	952-GRN48	



940P-GRN6 6' Extra Heavy Duty Bench, portable, 2"x4" green recycled plastic planks, galvanized frame

940 | EXTRA HEAVY-DUTY BENCH

- Available in 6' or 8' lengths
- Standard 2" x 4" planks with the option of 2" x 10" planks with powder coated or hot-dip galvanized frame
- All MIG welded frame
- Brace is 1" O.D. pipe
- All Zinc plated hardware
- Portable (P), inground (S), or surface mount (SM)
- See page 97 for frame color options and 95 for plank color options

6 FOOT	2" x 4"	2" x 10"	8 FOOT	2" x 4"	2" x 10"
	940-U6	940-U16		940-U8	940-U18
940-PT6	940-PT16	940-PT8	940-PT18		
940-T6	940-T16	940-T8	940-T18		
940-GRY6	940-GRY16	940-GRY8	940-GRY18		
940-CDR6	940-CDR16	940-CDR8	940-CDR18		
940-BRN6	940-BRN16	940-BRN8	940-BRN18		
940-GRN6	940-GRN16	940-GRN8	940-GRN18		
940-F6	(frame only)	940-F8	(frame only)		



965SM-BRN6 6' Double-Post Contour Park Bench, surface mount, brown recycled plastic planks, brown frame

965 | DOUBLE-POST CONTOUR PARK BENCH

- Available in 6' or 8' lengths
- Standard 2" x 4" planks with 8-slat contoured seating
- All MIG welded frame made of 2-3/8" O.D. pipe
- Frame can be powder coated or hot-dip galvanized
- Zinc plated hardware
- Inground (S), surface mount (SM) or Portable (P)
- See page 97 for frame color options and 95 for plank color options

6 FOOT	8 FOOT
965-U6	965-U8
965-PT6	965-PT8
965-T6	965-T8
965-GRY6	965-GRY8
965-CDR6	965-CDR8
965-BRN6	965-BRN8
965-GRN6	965-GRN8



975SM-PT6 6' Single-Post Contour Park Bench, surface mount, pressure treated wood planks, brown frame

975 | SINGLE-POST CONTOUR PARK BENCH

- Available in 6' or 8' lengths
- Standard 2" x 4" planks with 8-slat contoured seating
- All MIG welded frame made of 2-3/8" O.D. pipe
- Frame can be powder coated or hot-dip galvanized
- Zinc plated hardware
- Inground (S) or surface mount (SM)
- See page 97 for frame color options and 95 for plank color options

6 FOOT	8 FOOT
975-U6	975-U8
975-PT6	975-PT8
975-T6	975-T8
975-GRY6	975-GRY8
975-CDR6	975-CDR8
975-BRN6	975-BRN8
975-GRN6	975-GRN8



615-CDR6 6' Richmond Bench with Back, cedar recycled plastic planks, black frame

61 | RICHMOND BENCH WITH BACK

- 6' length
- Features 3" square tubing legs
- Recycled plastic planks or horizontal powder coated metal slats
- Powder coated frame finish
- Inground (S) or surface mount (SM)
- See page 95 for plank color options

6 FOOT
61-GRY6
61-CDR6
61-BRN6
61-GRN6



625-CDR6 6' Richmond Bench without Back, cedar recycled plastic planks, black frame

62 | RICHMOND BENCH WITHOUT BACK

- 6' length
- Features 3" square tubing legs
- Recycled plastic planks or horizontal powder coated metal slats
- Powder coated frame finish
- Inground (S) or surface mount (SM)
- See page 95 for plank color options

6 FOOT
62-GRY6
62-CDR6
62-BRN6
62-GRN6



992-GRN6 6' Bench without Back, 2 planters, portable, green recycled plastic planks

992/993 | RECYCLED PLASTIC BENCH WITH PLANTERS

- 6' Recycled frame with all zinc plated hardware
- Available with 2 (992) or 3 (993) planters
- Portable (P)
- See page 95 for plank color options
- Liners sold separately 01-05-0212

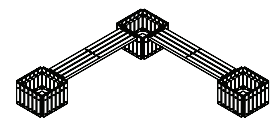

993



TABLES



238-GRN6 6' Extra Heavy-Duty Rectangular Table, green recycled plastic planks, portable, galvanized frame

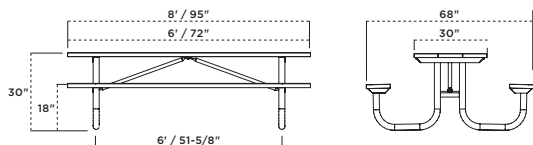

238 | EXTRA HEAVY-DUTY RECTANGULAR TABLE

- Available in 6' or 8' lengths with walk-through design
- 2" x 10" planks
- 2-3/8" O.D. all MIG welded frame with 1-5/16" O.D. brace
- Frame can be powder coated or hot-dip galvanized
- All galvanized hardware (for wood)
- All zinc plated hardware (for recycled plastic)
- Table has pre-drilled holes for a portable and/or surface mount frame
- See page 97 for frame color options and 95 for plank color options

6 FOOT	8 FOOT
238-U6	238-U8
238-PT6	238-PT8
238-T6	238-T8
238-GRY6	238-GRY8
238-CDR6	238-CDR8
238-BRN6	238-BRN8
238-GRN6	238-GRN8



238-PT6 6' Extra Heavy-Duty Rectangular Table, pressure treated planks, portable, galvanized frame

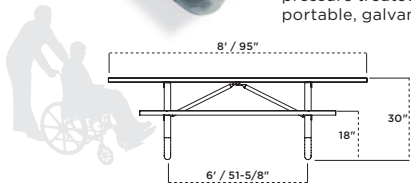

238H | ADA ACCESSIBLE TABLE

- Available in an 8' ADA accessible option with choice of double-sided (H) or single-sided (HS) accessibility
- Recycled planks available Double-Sided (H) only
- Frame can be powder coated or hot-dip galvanized
- All galvanized hardware (for wood)
- All zinc plated hardware (for recycled plastic)
- See page 97 for frame color options and 95 for plank color options

ADA Double-Sided	ADA Single-Sided
238H-U8	238HS-U8
238H-PT8	238HS-PT8
238H-T8	238HS-T8
238H-GRY8	
238H-CDR8	
238H-BRN8	
238H-GRN8	



238H-4-PT10 10' ADA Shelter Table, pressure treated planks, portable, brown frame

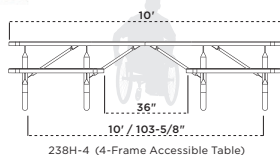

238H-4 (4-Frame Accessible Table)

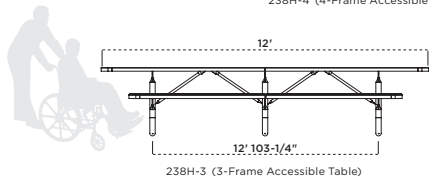

238H-3 (3-Frame Accessible Table)

238H | ADA SHELTER TABLE

- Available in 10' and 12' lengths with walk-through design
- Available as 3 or 4 frames
- 2" x 10" planks
- 2-3/8" O.D. all MIG welded frame with 1-5/16" brace
- Frame can be powder coated or hot-dip galvanized
- All galvanized hardware (for wood)
- All zinc plated hardware (for recycled plastic)
- Portable and/or surface mount
- See page 97 for frame color options and 95 for plank color options

10' ADA 4-Frame	12' ADA 3-Frame
238H-4-U10	238H-3-U12
238H-4-PT10	238H-3-PT12
238H-4-T10	238H-3-T12
238H-4-F10 (frame only)	238H-3-F12 (frame only)





238-3-T10 10' Shelter Table, redwood stain planks, portable, galvanized frame

238-3 | SHELTER TABLE

- Available in 10' and 12' lengths with walk-through design
- 2" x 10" planks
- 2-3/8" O.D. all MIG welded frame
- 1-5/16" O.D. brace
- Frame can be powder coated or hot-dip galvanized
- All galvanized hardware (for wood)
- All zinc plated hardware (for recycled plastic)
- Portable and/or surface mount
- See page 97 for frame color options and 95 for plank color options

10 FOOT	12 FOOT
238-3-U10	238-3-U12
238-3-PT10	238-3-PT12
238-3-T10	238-3-T12
238-3-F10 (frame only)	238-3-F12 (frame only)



BT238-BRN6 6' Bolt-Thru Extra Heavy-Duty Rectangular Table, portable, brown recycled planks, galvanized frame

BT238 | BOLT-THRU EXTRA HEAVY-DUTY TABLE

- 6' and 8' lengths
- 2" x 10" planks
- 2-3/8" O.D. bolt-thru frame
- 1-5/16" O.D. brace
- Frame can be powder coated or hot-dip galvanized
- All galvanized hardware (for wood)
- All zinc plated hardware (for recycled plastic)
- Portable and/or surface mount
- See page 97 for frame color options and 95 for plank color options

6 FOOT	8 FOOT
BT238-U6	BT238-U8
BT238-PT6	BT238-PT8
BT238-T6	BT238-T8
BT238-GRY6	BT238-GRY8
BT238-CDR6	BT238-CDR8
BT238-BRN6	BT238-BRN8
BT238-GRN6	BT238-GRN8
BT238-F6 (frame only)	BT238-F8 (frame only)



158-GRY6 6' Heavy-Duty Rectangular Table, portable, grey recycled plastic planks, black frame

158 | HEAVY-DUTY RECTANGULAR TABLE

- Available in 6' or 8' lengths with walk-through design
- 2" x 10" planks
- 1-5/8" O.D. all MIG welded frame with 1-5/16" O.D. brace
- Frame can be powder coated or hot-dip galvanized
- All galvanized hardware (for wood)
- All zinc plated hardware (for recycled plastic)
- Portable and/or surface mount
- See page 97 for frame color options and 95 for plank color options

6 FOOT	8 FOOT
158-U6	158-U8
158-PT6	158-PT8
158-T6	158-T8
158-GRY6	158-GRY8
158-CDR6	158-CDR8
158-BRN6	158-BRN8
158-GRN6	158-GRN8
158-F6 (frame only)	158-F8 (frame only)

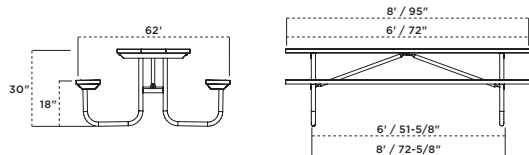

TABLES



158H-PT8 8' Double-Sided ADA Accessible Table, portable, pressure treated planks, galvanized frame

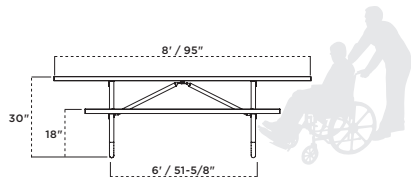

158H | ACCESSIBLE TABLE 

- Available in an 8' ADA accessible option with choice of single or double-sided accessibility
- Frame can be powder coated or hot-dip galvanized
- See page 97 for frame color options and 95 for plank color options

ADA Double-Sided	ADA Single-Sided
158H-U8	158HS-U8
158H-PT8	158HS-PT8
158H-T8	158HS-T8
158H-GRY8	
158H-CDR8	
158H-BRN8	
158H-GRN8	
158H-F8 (frame only)	158HS-F8 (frame only)



BT158-GRN6 6' Bolt-Thru Heavy-Duty Table, green recycled plastic planks, galvanized frame

BT158 | BOLT-THRU HEAVY-DUTY TABLE

- Available in 6' and 8' lengths
- 2" x 10" planks
- 1-5/8" O.D. all bolt together walk-through design
- 1-5/16" O.D. brace
- Frame can be powder coated or hot-dip galvanized
- All galvanized hardware (for wood)
- All zinc plated hardware (for recycled plastic)
- Portable and/or surface mount
- See page 97 for frame color options and 95 for plank color options

6 FOOT	8 FOOT
BT158-U6	BT158-U8
BT158-PT6	BT158-PT8
BT158-T6	BT158-T8
BT158-GRY6	BT158-GRY8
BT158-CDR6	BT158-CDR8
BT158-BRN6	BT158-BRN8
BT158-GRN6	BT158-GRN8
158-F6 (frame only)	BT158-F8 (frame only)



358-PT48 4-Seat 48" Square Table, pressure treated planks, galvanized frame

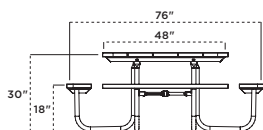

358 | 48" SQUARE TABLE

- 48" table with umbrella hole diameter 1-9/16" I.D.
- 1-5/8" O.D. all bolt together walk-through design
- 1" O.D. brace
- Frame can be powder coated or hot-dip galvanized
- All galvanized hardware (for wood)
- All zinc plated hardware (for recycled plastic)
- Portable and/or surface mount
- See page 97 for frame color options and 95 for plank color options

SQUARE TABLE
358-U48
358-PT48
358-T48
358-GRY48
358-CDR48
358-BRN48
358-GRN48





358H-CDR48 3-Seat 48" ADA Square Table, cedar recycled plastic planks, black frame

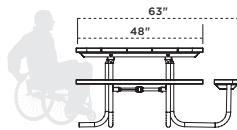

358H

358H | ADA 48" SQUARE TABLE

- 48" table with umbrella hole diameter 1-9/16" I.D.
- ADA accessible with 3-seat
- 1-5/8" O.D. all bolt together walk-through design
- 1" O.D. brace
- Frame can be powder coated or hot-dip galvanized
- All galvanized hardware (for wood)
- All zinc plated hardware (for recycled plastic)
- Portable and/or surface mount
- See page 97 for frame color options and 95 for plank color options

ADA 3-SEAT TABLE

358H-U48
358H-PT48
358H-T48
358H-GRY48
358H-CDR48
358H-BRN48
358H-GRN48



64-CDR6 6' Richmond Table, portable, cedar recycled plastic planks, black frame

63/64 | RICHMOND TABLE

- 6' length
- 2" x 4" recycled plastic planks
- 2-3/8" O.D. frames
- Powder coated frame
- Available as a multi pedestal table (63) or portable table with a walk-through design (64)
- Inground or surface mount (63) and portable (64)
- See page 95 for plank color options

63 SERIES	64 SERIES
63-GRY6	64-GRY6
63-CDR6	64-CDR6
63-BRN6	64-BRN6
63-GRN6	64-GRN6



349SM-GRN6 6' Multi-Pedestal Table, surface mount, green recycled plastic planks, black frame

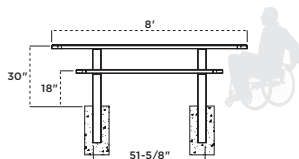

349H

349/348 | MULTI-PEDESTAL TABLE

- Available in 6', and 8' lengths with ADA double-sided accessibility
- 2" x 10" (349) or 3" x 4" (348) recycled plastic planks
- 4" square post all MIG welded frame with walk-through design
- Powder coated frame
- All galvanized hardware (for wood)
- All zinc plated hardware (for recycled plastic)
- Inground (S) or surface mount (SM)
- See page 97 for frame color options and 95 for plank color options

	6 FOOT	8 FOOT	ADA 8 FOOT
SERIES 349	349-U6	349-U8	349H-U8
	349-PT6	349-PT8	349H-PT8
	349-T6	349-T8	349H-T8
	349-GRY6	349-GRY8	349H-GRY8
	349-CDR6	349-CDR8	349H-CDR8
	349-BRN6	349-BRN8	349H-BRN8
	349-GRN6	349-GRN8	349H-GRN8
SERIES 348	348-GRY6	348-GRY8	348H-GRY8
	348-CDR6	348-CDR8	348H-CDR8
	348-BRN6	348-BRN8	348H-BRN8
	348-GRN6	348-GRN8	348H-GRN8



TABLES



358SM-PT48 4-Seat Single Pedestal Table, pressure treated planks, black frame

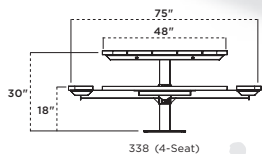

338 (4-Seat)

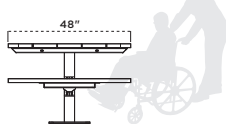

338H2 (Double-Sided Accessibility)

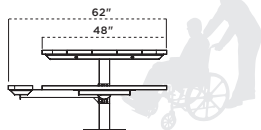

338H3 (Single-Sided Accessibility)

338/338H | 48" SINGLE PEDESTAL TABLE

- 48" table with umbrella hole diameter 1-9/16" I.D.
- ADA accessible with 2-seat or 3-seat option
- 4" x 4" all MIG welded frame with 2-7/8" O.D. round support arms
- Powder coated frame
- All zinc plated hardware
- Inground (S) or surface mount (SM)
- See page 97 for frame color options and 95 for plank color options

4-SEAT	ADA 3-SEAT	ADA 2-SEAT
338-U48	338H3-U48	338H2-U48
338-PT48	338H3-PT48	338H2-PT48
338-T48	338H3-T48	338H2-T48
338-GRY48	338H3-GRY48	338H2-GRY48
338-CDR48	338H3-CDR48	338H2-CDR48
338-BRN48	338H3-BRN48	338H2-BRN48
338-GRN48	338H3-GRN48	338H2-GRN48



347-PT6 6' Dual Pedestal Rectangular Table, pressure treated planks, brown frame

347 | DUAL PEDESTAL RECTANGULAR TABLE

- Available in 6' or 8' lengths with attached seats
- 2" x 10" planks
- Optional 8' ADA version with double-sided accessibility
- 4" x 4" all MIG welded frame
- Powder coated frame
- All zinc plated hardware (for recycled plastic)
- Inground (S) or surface mount (SM)
- See page 97 for frame color options and 95 for plank color options

6 FOOT	8 FOOT	ADA 8 FOOT
347-U6	347-U8	347H-U8
347-PT6	347-PT8	347H-PT8
347-T6	347-T8	347H-T8
347-GRY6	347-GRY8	347H-GRY8
347-CDR6	347-CDR8	347H-CDR8
347-BRN6	347-BRN8	347H-BRN8
347-GRN6	347-GRN8	347H-GRN8



337-PT6 6' Single Pedestal Rectangular Table, untreated planks, black frame

337 | SINGLE PEDESTAL RECTANGULAR TABLE

- This table is ADA accessible and comes in 4' or 6' lengths
- 4" x 4" square main post with 3" x 3" square arm posts
- 2" x 10" planks
- Powder coated frame
- All galvanized hardware (for wood)
- All zinc plated hardware (for recycled plastic)
- Inground (S) or surface mount (SM)
- See page 97 for frame color options and 95 for plank color options

4 FOOT	6 FOOT
337-U4	337-U6
337-PT4	337-PT6
337-T4	337-T6
337-GRY4	337-GRY6
337-CDR4	337-CDR6
337-BRN4	337-BRN6
337-GRN4	337-GRN6





TR-32-CDR Round Receptacle with
FT-32-08 Flat Top Lid, cedar recycled planks

TR-32 | ROUND RECEPTACLE

- 32 gallon capacity
- 34" high with a 26-11/16" diameter
- 2" x 4" planks in wood or recycled plastic
- All zinc plated hardware
- Portable with mounting kit sold separately
- Lid and liner sold separately
- See page 95 for plank color options

ROUND RECEPTACLE

TR-32-U	TR-32-GRY
TR-32-PT	TR-32-CDR
TR-32-T	TR-32-BRN
	TR-32-GRN



TRSQ-32-BRN Square Receptacle with
FT-32-TRSQ Flat Top Lid, brown recycled planks

TRSQ-32 | SQUARE RECEPTACLE

- 32 gallon capacity
- 34" high and 27" wide
- 2" x 4" planks in wood or recycled plastic
- All zinc plated hardware
- Portable with mounting kit sold separately
- Lid and liner sold separately
- See page 95 for plank color options

SQUARE RECEPTACLE

TRSQ-32-U	TRSQ-32-GRY
TRSQ-32-PT	TRSQ-32-CDR
TRSQ-32-T	TRSQ-32-BRN
	TRSQ-32-GRN



TRSQ-40-GRN Double Recycling
Receptacle, green recycled plastic planks

TRSQ-20/40/60 | RECYCLING RECEPTACLE

- Available as a single, double or triple recycling receptacle
- 2" x 4" planks in recycled plastic planks
- All zinc plated hardware
- Lid and liner sold separately
- Portable with mounting kit sold separately
- Choose between: Trash, Cans, Plastic, Paper, or Glass
- See page 95 for plank color options

SINGLE RECYCLING RECEPTACLE	DOUBLE RECYCLING RECEPTACLE	TRIPLE RECYCLING RECEPTACLE
TRSQ-20-GRY	TRSQ-40-GRY	TRSQ-60-GRY
TRSQ-20-CDR	TRSQ-40-CDR	TRSQ-60-CDR
TRSQ-20-BRN	TRSQ-40-BRN	TRSQ-60-BRN
TRSQ-20-GRN	TRSQ-40-GRN	TRSQ-60-GRN



CH-GRN32FT Charleston
Receptacle, green recycled
plastic planks

CH | CHARLESTON RECEPTACLE

The Charleston Receptacle features powder coated decorative rosettes around the top of the receptacle.

- 32 gallon capacity
- 2" x 4" recycled plastic planks
- Lid and liner are included
- Portable with mounting kit sold separately
- See page 95 for plank color options

FLAT TOP	ASH URN	RAIN BONNET
CH-R32FT	CH-R32AU	CH-R32RB



RECEPTACLES & PLANTERS



60-CDR34 Richmond Trash Receptacle, cedar recycled plastic planks

60 | RICHMOND TRASH RECEPTACLE

- 32 gallon capacity
- Available in recycled plastic planks
- Features metal accent tubes
- Includes liner and flat top lid
- See page 95 for plank color options

TRASH RECEPTACLE

60-CDR34



RD2418-BRN Round Planter, brown recycled plastic planks



SQ2418-GRN Square Planter, green recycled plastic planks

RD2418/SQ2418 | PLANTER

- 18" high and 26-3/4" wide
- 2" x 4" planks in wood or recycled plastic
- All zinc plated hardware
- Portable with mounting kit sold separately
- See page 95 for plank color options
- 01-05-0212 Liner sold separately

ROUND PLANTER

RD2418-U
RD2418-PT
RD2418-T
RD2418-GRY
RD2418-CDR
RD2418-BRN
RD2418-GRN

SQUARE PLANTER

SQ2418-U
SQ2418-PT
SQ2418-T
SQ2418-GRY
SQ2418-CDR
SQ2418-BRN
SQ2418-GRN



FT-32-TRSQ
Flat Top Lid



RB-32-TRSQ
Rain Bonnet Lid



AU-32-TRSQ
Ash Urn Lid

SQUARE RECEPTACLE LIDS

- Fits our 32 gallon receptacles
- 14 gauge
- All MIG welded frame (AUR & RBR)
- See page 42 for round receptacle lids
- Thermoplastic coated
- See page 97 for color options



SM KIT Surface Mounting Kit



IG KIT Inground Mounting Kit

RECEPTACLE MOUNTING KITS

Most trash receptacles are portable and can be converted into either inground (IG) or surface mount (SM). Kits fit 32, 36 (IG only), and 55 gallon receptacles. Sold separately

- 2-3/8" O.D. all MIG welded pipe
- Powder coated black finish

SIZE **INGROUND** **SURFACE**

32 GAL	IG KIT	SM KIT
36 GAL	IG KIT	--
55 GAL	IG KIT	SM KIT





Customization available!

20/21 | RECYCLED BENCH WITH BACK

- Available in 6' or 8' lengths
- Series 20 has six 2" x 4" recycled plastic planks
- Series 21 has four 2" x 6" recycled plastic planks
- Recycled plastic frame
- All zinc plated hardware
- Portable only
- Available in 3 plank colors: cedar, green, grey

20-CDR6 6' Recycled Bench with Back, portable, green recycled plastic planks, black frame

20 SERIES	6 FOOT	8 FOOT	21 SERIES	6 FOOT	8 FOOT
	20-GRY6	20-GRY8		21-GRY6	21-GRY8
20-CDR6	20-CDR8	21-CDR6	21-CDR8		
20-GRN6	20-GRN8	21-GRN6	21-GRN8		



22-GRY6 6' Recycled Bench without Back, portable, grey recycled plastic planks, black frame

22 | RECYCLED BENCH WITHOUT BACK

- Available in 6' or 8' lengths
- Three 2" x 4" recycled plastic planks
- Recycled plastic frame
- All zinc plated hardware
- Portable only
- Available in 3 plank colors: cedar, green, grey

6 FOOT	8 FOOT
22-GRY6	22-GRY8
22-CDR6	22-CDR8
22-GRN6	22-GRN8



26-HEX-GRN 6' Hexagon Table, green recycled plastic planks, black frame

26 | RECYCLED PICNIC TABLES

- 6' hexagon table
- Recycled plastic planks and frame
- All zinc plated hardware
- Portable and/or surface mount
- Available in 2 plank colors: cedar or green

6 FOOT
26-HEX-CDR
26-HEX-GRN



24-CDR6 6' Rectangular Table, cedar recycled plastic planks, black frame

24 | RECYCLED PICNIC TABLES 

- Available in 6' or 8' lengths
- Optional 8' ADA version
- Recycled plastic planks and frame
- All zinc plated hardware
- Portable and/or surface mount
- Available in 3 plank colors: cedar, green, grey

6 FOOT	8 FOOT	ADA 8 FOOT
24-CDR6	24-CDR8	24H-CDR8
24-GRN6	24-GRN8	24H-GRN8
24-GRY6	24-GRY8	24H-GRY8



ALUMINUM



682-T Double-Sided Galvanized Trash Receptacle

682 | GALVANIZED TRASH RECEPTACLE

The galvanized trash receptacles and lids can be ordered separately or with inground post and holder(s).

- 3-1/2" O.D. Post
- 1/2" Steel Bar
- 4" O.D. Adjustable Collar
- Portable (P) or inground (S)

	30 GAL CAN	30 GAL LID	HOLDER	CAN, HOLDER, CHAIN
Single-Sided	G31	L31	681	681-T
Double-Sided	—	—	682	682-T



940-A6 6' Aluminum Bench, portable, galvanized frame

940 | ALUMINUM BENCH

- Available in 6', 8', 15', and 21' lengths
- Standard 2" x 10" Aluminum Planks
- Frame can be powder coated or hot-dip galvanized
- Portable (P), inground (S), or surface mount (SM)

6 FOOT	8 FOOT	15 FOOT	21 FOOT
940-A6	940-A8	940-A15	940-A21



942-A15 15' Aluminum Team Bench, portable, galvanized frame

942 | PARK & TEAM BENCHES | WITHOUT BACK

- Available in 6', 8', 15' or 21' lengths
- 2" x 10" aluminum, wood, or recycled plastic style planks
- All MIG welded frame with zinc plated hardware
- Frame can be powder coated or hot-dip galvanized
- Brace is 1" O.D. pipe
- Portable (P), inground (S), or surface mount (SM)

6 FOOT	8 FOOT	15 FOOT	21 FOOT
942-A6	942-A8	SIG15	SIG21

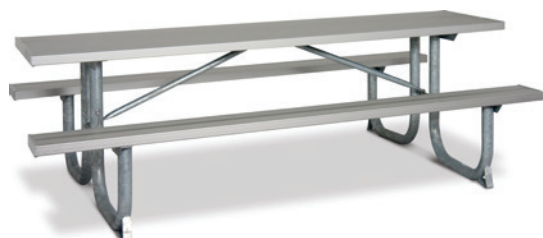

238-A8 8' Extra Heavy-Duty Rectangular Table, aluminum, galvanized frame

238/238H | EXTRA HEAVY-DUTY
158/158H | RECTANGULAR TABLE

- Available in 6', 8', 10' or 12' lengths with walk-through design
- 2" x 10" planks
- 2-3/8" O.D. all MIG welded frame with 1-5/16" O.D. brace (238/238H)
- 1-5/8" O.D. all MIG welded frame with 1-5/16" O.D. brace (158/158H)
- Frame can be powder coated or hot-dip galvanized
- All zinc plated hardware
- Table has pre-drilled holes for a portable and/or surface mount frame

6 FOOT	Bolt-Thru 6 FOOT	8 FOOT	Bolt-Thru 8 FOOT	10 FOOT	12 FOOT
238-A6	FT238-A6	238-A8	FT238-A8	238-3-A10	238-4-A12
158-A6	—	158-A8	—	—	—
ADA 8 FOOT (double-sided)	ADA 8 FOOT (single-sided)	ADA 10 FOOT	ADA 12 FOOT		
238H-A8	238HS-A8	238H-3-A10	238H-3-A12		
158H-A8	158HS-A8	—	—		





P257 Kid's Size Park Bench

257 | KID'S SIZE PARK BENCH

- 1" O.D. all MIG welded pipe with 1" O.D. brace
- All zinc plated hardware
- Comes standard with red high density polyethylene planks and a green powder coated frame
- Seats and backs are 9" x 36"
- Portable

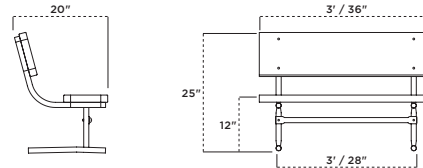

P557-PE4BL 4' Heavy-Duty Preschool Table

557 | HEAVY-DUTY 4' PRESCHOOL TABLE

- 1-5/8" O.D. all MIG welded pipe with 1" O.D. brace
- Walk through design
- All zinc plated hardware
- Available with green or blue high density polyethylene planks with powder coated frame
- Seats are 9" x 48" and table top is 30" x 48"
- Portable



357-G 46" Preschool Table

357 | 46" PRESCHOOL TABLE

- 1" O.D. all bolt together frame with 1" O.D. brace
- Walk through design
- All zinc plated hardware
- Features high density polyethylene planks with zinc plated or powder coated frame
- Seats are 9" x 48" and table top is 30" x 48"
- Portable

GREEN PLANKS YELLOW FRAME	RED & GREEN PLANKS YELLOW FRAME
357-G	357-MC

GREEN PLANKS ZINC PLATED FRAME	RED & GREEN PLANKS ZINC PLATED FRAME
357	357-MC







See pages 42-45 to view Premium receptacles

LX-36 | LEXINGTON RECEPTACLE

- 36 gallon capacity
- Only available in powder coated finish
- 1/8" x 2" steel flat bar
- All MIG welded frame
- All stainless steel hardware
- Portable and/or surface mount
- Lid and liner included

LX-36FT Lexington Trash Receptacle, vertical slat pattern, beige with matching flat top lid



See page 46-47 to view UltraCoat receptacles

METAL TRASH RECEPTACLE

- Available in 32 or 55 gallon capacities
- Thermoplastic finish
- All MIG welded unit
- Portable with mounting kit sold separately
- Lid and liner sold separately

EX-32 Metal Trash Receptacle, blue diamond pattern with **FTR-32-08** Flat Top Lid and **PL-32** Liner



See page 65 to view Natural receptacles

TR-32 | ROUND RECEPTACLE

- 32 gallon capacity
- 34" high with a 26-11/16" diameter
- 2" x 4" planks in wood or recycled plastic
- All zinc plated hardware
- Portable with mounting kit sold separately
- Lid and liner sold separately

TR-32-CDR Round Receptacle with cedar recycled planks
FT-32-TR Flat Top Lid



See page 49 to view planters

RD2418-LX | LEXINGTON PLANTER

- 24" wide x 18" high planters
- Powder coated finish
- 1/8" x 2" steel flat bar
- All MIG welded frame
- Portable and/or surface mount
- Inground mounting kit available - sold separately

RD2418-LX Lexington Planter, brown vertical slat pattern





MUV-70 7' UltraSite Umbrella with wooden pole, natural



MUV-70 7' UltraSite Umbrella with wooden pole, pacific blue

MUV | ULTRASITE® UMBRELLA

- Wooden pole
- Acrylic Fabric
- Manual lift system
- Threaded coupling
- Vented top
- Machine washable cover
- See page 73 for color options

7 FOOT DIAMETER	9 FOOT DIAMETER
MUV-70	MUV-90

758 | ULTRASITE® UMBRELLA

- Anodized aluminum pole with 3-position tilt
- (8) 3/8" diameter zinc plated steel spring wire
- Your choice of manual or crank lift
- Alternating color panels available with upcharge
- Umbrella post diameter 1-5/8" O.D.
- See page 73 for color options



7-1/2' GRADE A Textilene Open Weave	7-1/2' GRADE B Textilene Closed Weave
758A-75	758B-75

758A-75 7-1/2' UltraSite Umbrella with anodized aluminum pole, red





7G-CRA UltraSite Umbrella with bright aluminum pole, forest green



7G-CRW UltraSite Umbrella with white aluminum pole, pacific blue

7GC | ULTRASITE® UMBRELLA

The unique fiberglass support rib construction ensures strength, resilience, and durability and holds up to the harshest weather conditions—intense sunlight, high winds, salt air, and driving rain—and will not decay or lose its shape. Our flexible fiberglass ribs absorb wind gusts without breaking and last four to five times longer than traditional steel or wood ribbed umbrellas.

- Two piece post construction
- (6) 3/8" diameter fiberglass ribs
- Each umbrella weighs 15 lbs (plus packaging)
- Molded nylon joints and end tips
- .065" thick aluminum post
- Umbrella post diameter 1-1/2" O.D.
- Anodized and powder coated finishes
- Crank lift mechanism
- Top with valance in vinyl coated weave only
- Alternating colors are not available
- See below for color options

White Aluminum Pole	Champagne Aluminum Pole	Bright Aluminum Pole
7G-CRW	7G-CRC	7G-CRA

MUV COLOR OPTIONS



758 COLOR OPTIONS OPEN WEAVE



758 COLOR OPTIONS CLOSED WEAVE

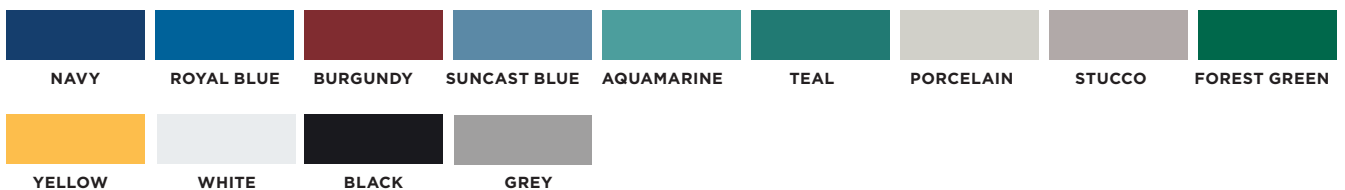

7GC COLOR OPTIONS



BOLLARDS

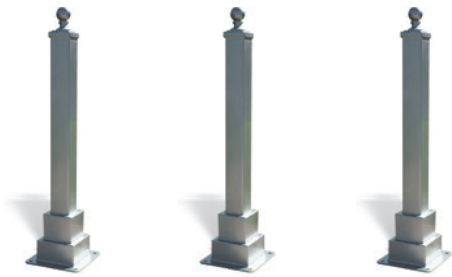

2003/2004 | HAMPTON SERIES

- 4" width
- Available in 3' and 4' heights
- Powder coated finish
- 1 and 2 Loop options available for use with chain
- Surface mount (SM) or inground (S)
- See page 97 for color options

	3 FOOT	4 FOOT
4" width	2003	2004



2633/2833 | CLASSIC BIKE BOLLARD

- Available in 6" or 8" diameters
- Available in 3' and 4' heights
- Powder coated finish
- Surface mount (SM) or inground (S)
- See page 97 for color options

	3 FOOT	4 FOOT
6" diameter	2633	2634
8" diameter	2833	2834



2023/2024 | DOVER SERIES

- 6" width
- Available in 3' and 4' heights
- Powder coated finish
- Surface mount (SM) or inground (S)
- See page 97 for color options

	3 FOOT	4 FOOT
6" width	2023	2024



2013/2014 | MODERN BIKE BOLLARD

- 4" width
- Available in 3' and 4' heights
- 1 and 2 Loop options available for use with chain
- Powder coated finish
- Surface mount (SM) or inground (S)
- See page 97 for color options

	3 FOOT	4 FOOT
4" width	2013	2014



2803/2804 | SAFETY BOLLARD

- 8" diameter
- Available in 3' and 4' heights
- 1 and 2 Loop options available for use with chain
- Powder coated finish
- Surface mount (SM) or inground (S)
- See page 97 for color options

	3 FOOT	4 FOOT
8" diameter	2803	2804





2624 | SHORELINE

- Available in 6" or 8" diameters
- Available in 3' and 4' heights
- Powder coated finish
- Surface (SM) or inground (S)
- See page 97 for color options

	3 FOOT	4 FOOT
6" diameter	2623	2624
8" diameter	2823	2824

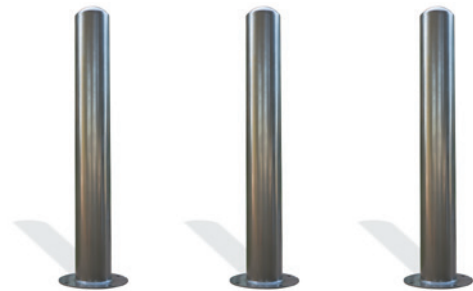

2603/2604 | NEWPORT SERIES

- 6" diameter
- Available in 3' and 4' heights
- 1 and 2 Loop options available for use with chain
- Powder coated finish
- Surface mount (SM) and inground (S)
- See page 97 for color options

	3 FOOT	4 FOOT
6" diameter	2603	2604



2643/2843 | FAIRFAX

- Available in 6" or 8" diameters
- Available in 3' and 4' heights
- Powder coated finish
- Surface mount (SM) or inground (S)
- See page 97 for color options

	3 FOOT	4 FOOT
6" diameter	2643	2644
8" diameter	2843	2844

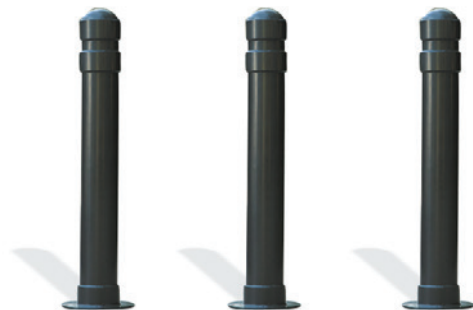

2613/2813 | ROCKLAND SERIES

- 6" and 8" diameters
- Available in 3' and 4' heights
- 1 and 2 Loop options available for use with chain
- Powder coated finish
- Surface mount (SM) or inground (S)
- See page 97 for color options

	3 FOOT	4 FOOT
6" diameter	2613	2614
8" diameter	2813	2814



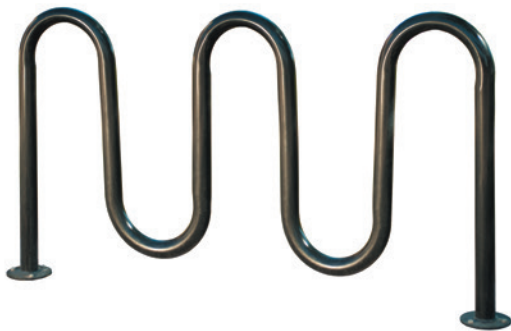

5805SM Contemporary 5 Loop Bike Rack, surface mount

5800 | CONTEMPORARY LOOP BIKE RACK

- 1, 3, 5, 9, and 11 loop options
- 2-3/8" O.D. steel tubing
- Available as hot-dip galvanized or optional powder coated finish
- Inground (S) or surface mount (SM)
- See page 97 for color options

1 LOOP 1'3" 2 bikes	3 LOOP 2'3" 5 bikes	5 LOOP 5'3" 7 bikes	9 LOOP 9'3" 11 bikes	11 LOOPS 11'3" 13 bikes
5801	5803	5805	5809	5811

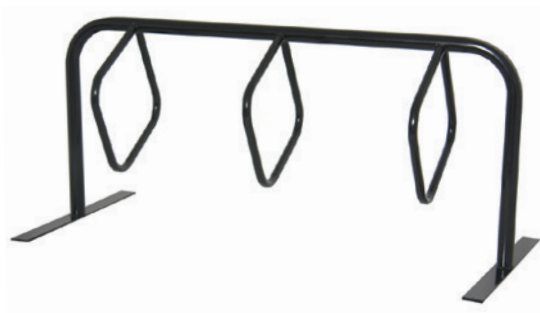
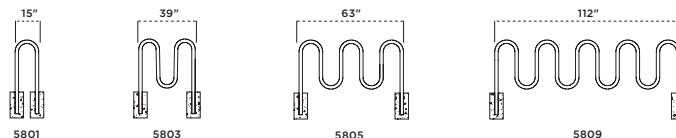

5603 Hanger Rack, 3-Loop, black

5603/5604/5605 | HANGER RACK

- 3, 4, and 5 loop options
- Round tubing
- Powder coated finish
- Portable (P) and/or surface mount (SM)
- See page 97 for color options

3 LOOP 6'3" 6 bikes	4 LOOP 8'3" 8 bikes	5 LOOP 10'3" 10 bikes
5603	5604	5605

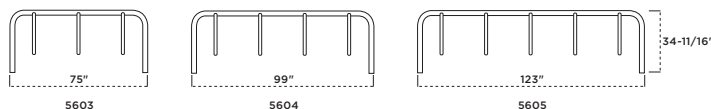

5801SM Standard Inverted Rack

5801/5801D | INVERTED SERIES

- 1, 2, 3, 4, and 5 loop options on c-channel rails
- 14.5" wide standard / 30" wide deluxe (D)
- Round tubing
- Powder coated finish
- Surface mount only
- See page 97 for color options

2 LOOP 3' 4 bikes	3 LOOP 5.5' 6 bikes	4 LOOP 8' 8 bikes	5 LOOP 10.5' 10 bikes
5801-2	5801-3	5801-4	5801-5
5801D-2	5801D-3	5801D-4	5801D-5





5821D Deluxe Inverted Rack

5821/5821D | INVERTED SERIES

- 1, 2, 3, 4, and 5 loop options on c-channel rails
- 18" wide standard / 30" wide deluxe (D)
- Square tubing
- Powder coated finish
- Surface mount only
- See page 97 for color options

2 LOOP 3' 4 bikes	3 LOOP 5.5' 6 bikes	4 LOOP 8' 8 bikes	5 LOOP 10.5' 10 bikes
5821-2	5821-3	5821-4	5821-5
5821D-2	5821D-3	5821D-4	5821D-5



5030 | FLARE RACK

- Capacity up to 2 bikes
- 38-7/16" high x 26-1/4" wide
- Framework is 2-3/8" O.D. pipe
- Powder coated finish
- Inground (S) or surface mount (SM)
- See page 97 for color options

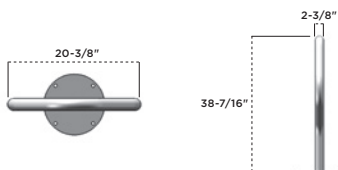

5040 | HITCH RACK

- Capacity up to 2 bikes
- 36" high x 20" wide
- 2-3/8" O.D. 12 gauge steel tubing
- Rings are 1-5/16" x 14 gauge zinc tubing
- Powder coated finish
- Inground (S) or surface mount (SM)
- See page 97 for color options

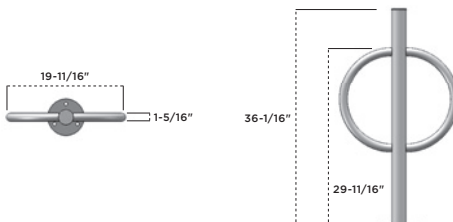



632 Rotating Grill



5020 | HORIZONS RACK

- Capacity up to 2 bikes
- Framework is 2" square x 11 gauge steel tubing
- Powder coated finish
- Inground (S) or surface mount (SM)
- See page 97 for color options

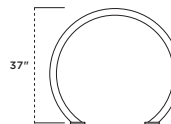
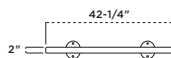

5000 | SOLSTICE RACK

- Capacity up to 2 bikes
- Framework is 1.9" O.D. round x 11 gauge steel tubing
- Powder coated finish
- Inground (S) or surface mount (SM)
- See page 97 for color options

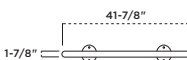



280 square inches of cooking area

616 | ROTATING FLIP-BACK GRILL

- Grill measures 20"L x 14"D x 8"H
- Grill rotates a full 360°
- Durable rust-resistant high-temp black powder coated firebox
- Optional hot-dip (G) galvanized firebox
- 4-level adjustable cooking grate has cool-coil handles
- Grate flips back for easy clean-up and fire building
- All MIG welded 7 ga. base plate with 10 ga. side plates
- Galvanized iron pipe post inground mount
- ADA version available

	2-3/8" post	2-3/8" post with shelf	3-1/2" post	3-1/2" post with shelf
Standard	616	616-U	616-3	616-3-U
Galvanized	616G	616G-U	616G-3	616G-3-U



Lockable grill cover available (P-01-03-0135)

550 square inches of cooking area

650 | DUAL GRATE GRILL

- Grill measures 20"L x 28"D x 8"H
- Durable rust-resistant high-temp black powder coated firebox
- Optional hot-dip (G) galvanized firebox
- 4-level adjustable cooking grate has cool-coil handles
- All MIG welded 7 ga. base plate with 10 ga. side plate
- 2-3/8" O.D. posts: permanent inground mount
- Optional lockable grill cover: P-01-03-0135 (for use when grill is out of service)



Lockable grill cover available (P-01-03-0133)

280-300 square inches of cooking area

620/630 | ADJUSTABLE ROTATING GRILL

- 620 measures 20"L x 14"D x 8"H with 280 square inch cooking area
- 630 measures 20"L x 15"D x 10"H with 300 square inch cooking area
- Grill rotates a full 360°
- Durable rust-resistant, high-temp, black powder coated firebox
- Optional hot-dip (G) galvanized firebox
- 4-level adjustable cooking grate has cool-coil handles
- All MIG welded 7 ga. base plate with 10 ga. side plate
- 2-3/8" O.D. post (Standard on the 620) inground mount
- 3-1/2" O.D. post (Recommended on the 630) inground mount
- Optional lockable grill cover: P-01-03-0133 (for use when grill is out of service)

620 SERIES	2-3/8" post	2-3/8" post with shelf	3-1/2" post
Standard	620	620-U	620-3
ADA Standard	620H	—	620H-3
Galvanized	620G	620G-U	620G-3
ADA Galvanized	620HG	—	620HG-3

630 SERIES	2-3/8" post	2-3/8" post with shelf	3-1/2" post
Standard	630	630-U	630-3
ADA Standard	—	—	630H-3
Galvanized	630G	630G-U	630G-3
ADA Galvanized	—	—	630HG-3



1,008 square inches of cooking area

621 | BI-LEVEL GRILL

- Grill measures 28"L x 36"D x 10"H
- Durable rust-resistant, high-temp, black powder coated firebox
- Includes a utility shelf with a 4-level adjustable cooking grate
- 4" square post with 1/4" gussets for additional support
- All MIG welded 7 ga. base plate and side walls
- Inground (S) or surface mount (SM)



GRILLS



*1,064 square inches
of cooking area*

627 | COMMERCIAL GRILL

- Grill measures 28"L x 36"D x 10"H
- Durable rust-resistant, high-temp black powder coated firebox
- Cantilever cooking grate
- Grill features a double-flip-back cooking surface for easy cleaning
- 4" sq. post support tubing
- All MIG welded 7 ga. base plate with 10 ga. side walls
- Inground (S) or surface mount (SM)



*300 square inches
of cooking area*

632 | ROTATING GRILL

- Grill measures 20-1/16"L x 18-5/16"D x 40"H
- Grill rotates a full 360°
- Durable rust-resistant high-temp black powder coated firebox
- Cantilever cooking grate
- All MIG welded 7 ga. base plate with 10 ga. side walls
- Inground (S) or surface mount (SM)

	3-1/2" post	3-1/2" post ADA
Standard	632-3	632H-3
Galvanized	632G-3	632HG-3



*300 square inches
of cooking area*

600 | FIRE RING

- 32" diameter x 30" deep
- Durable rust-resistant, high-temp, black powder coated firebox
- Cooking grate is permanently attached with a cool-coil handle
- Grate flips back for easy clean-up and fire building
- All MIG welded 7 gauge outer wall with 1" safety lip
- Staple anchors are included for a permanent inground mount
- Fire ring only; ADA accessible double fire ring available

	7" HIGH	9" HIGH	18" HIGH ADA	18" HIGH ADA
With Grate	600	600-9	600H	600H-D (with inner ring)
No Grate	601	601-9	—	—



*285 square inches
of cooking area*

612 | MULTI-FUNCTIONAL FIRE RING

- 32" diameter x 30" deep
- Durable rust-resistant, high-temp, black powder-coat firebox
- Permanently mounted 4-level adjustable cooking grate with cool-coil handles
- All MIG welded 7 gauge outer wall with 1" safety lip
- Staple anchors are included for a permanent inground mount

7" HIGH	9" HIGH	18" HIGH ADA	18" HIGH ADA
612	612-9	612H	612H-D (with inner ring)





670 | LANTERN HANGER

- Standard galvanized finish
- Powder coated finish is optional
- 2-3/8" O.D. all MIG welded pipe
- End cap and lantern hook included
- Available as ADA accessible (670H)
- Inground mount



110/115 | GOLF BAG STANDS

The Golf Bag Stand is available with or without a bench. The golf bag holder has a 6, 8, 12, or 16-bag capacity.

- 6' or 8' lengths
- Thermoplastic finish with powder coated frame
- 2-3/8" all MIG welded frame
- All stainless steel hardware
- Portable and/or surface mount
- See page 97 for color options

6-BAG	8-BAG	8-BAG w/ bench	12-BAG	16-BAG
110-16V	110-18V	115-28V	110-26V	110-28V
110-16P	110-18P	115-28P	110-26P	110-28P

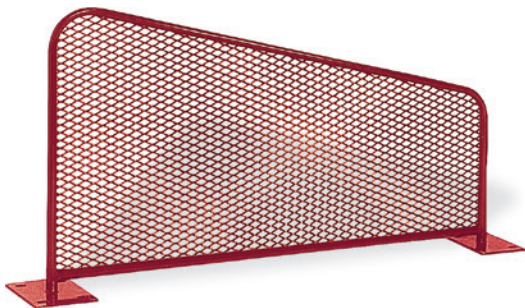

100/105 | GOLF RANGE DIVIDERS

The UltraSite® Tee/Driving Range Dividers are designed for safety to deflect golf balls.

- Thermoplastic finish
- 1" all MIG welded
- Diamond pattern only
- 105 Golf Range Divider comes with golf bag rest
- Inground (S) or surface mount (SM)
- See page 97 for color options

Inground	Surface Mount
110S-V	100SM-V
105S-V	105SM-V

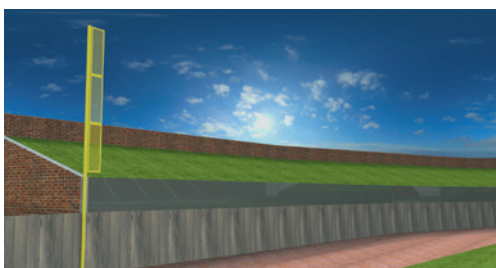

119S-V20 | FOUL BALL POLES

- Two piece bolt together construction
- 3-1/2" OD 11 ga steel tubing
- Wing Panel is 12 ga expanded metal design
- Powder coated finish
- Inground only, Ground sleeves (G-03-02-0022) sold separately
- See page 97 for color options



SHOWCASE



Distributed by: Efficient Amenities



EFFICIENT AMENITIES

Call Us Today.



(855) 884-8387



PBARK-410 Dog Walk & PBARK-420 Paws/Grooming Table

BarkPark® by UltraSite® offers dog park equipment based on popular agility obstacles and has been developed for use by dogs of all abilities and confidence levels.

Most of all, BarkParks build attractive and fun places for pets and their families to exercise, socialize, and enjoy nature!

Visit our website to view the full line and get access to our complete catalog:

www.dogparkproduct.com



TBARK-430 Hoop Jump



PBARK-470 Stepping Paws



BarkParks's proprietary CanineCoat™ provides slip-resistant traction, UV protection, and resistance to vandalism and urine.



BARKPARK

AGILITY OBSTACLES

BarkPark agility obstacles are developed for use by dogs of all abilities and confidence levels.



PBARK-450 Rover Jump Over



PBARK-440 Teeter Totter

COORDINATING SITE AMENITIES

Featuring laser cut paw prints and bones to coordinate with your BarkPark equipment.

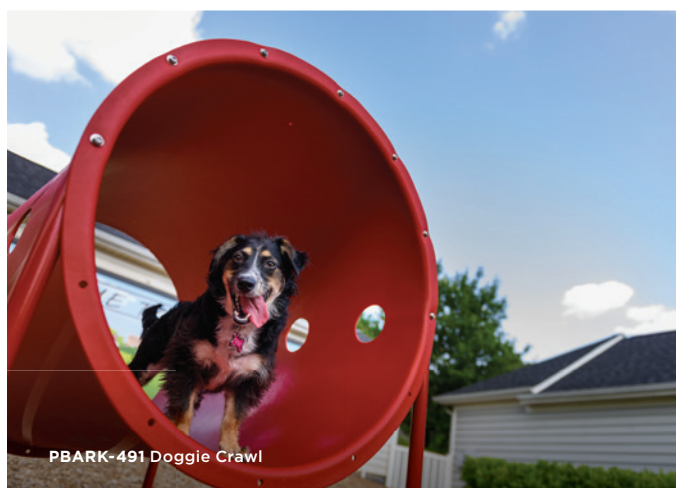

PBARK-491 Doggie Crawl

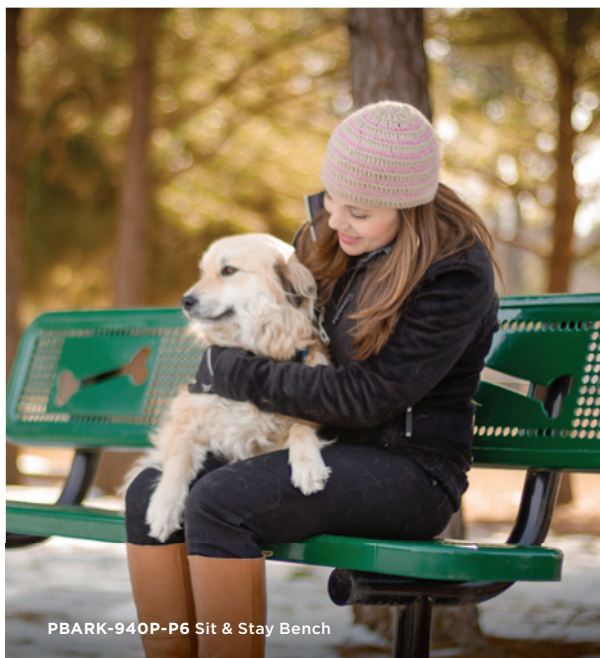

PBARK-940P-P6 Sit & Stay Bench



TBARK-PR-32 Tidy Up Trash Receptacle shown with FTR-32-08 Flat Top Lid and PL-32 Liner, sold separately





BARK-NVKIT Novice Course (includes Doggie Crawl, Hoop Jump, Paws/Grooming Table, and Rover Jump Over)

PRE-CONFIGURED AGILITY COURSES

Save time and money when you purchase one of our expertly configured courses!



UNLEASHED

Request a copy of Unleashed, a research-based guidebook developed by PlayCore to help communities plan, fund, build, and advocate for dog parks!



PBARK-490 Pet Waste Station



PBARK-488 Pet Waste Station without Receptacle



TBARK-465 Fire Hydrant

ACCESSORIES

From Fire Hydrants to Waste Stations, BarkPark has all of your finishing touches!



ACTIONFIT

UP306 Boot Camp Package

ActionFit® by UltraSite® is positively impacting landscapes with modern, attractive, outdoor fitness equipment that can be available 24 hours a day 7, days a week.

Designed for ages 13 and up, ActionFit® encourages interaction and the importance of getting fit.

Visit our website to view the full fitness product line and get access to our complete catalog:
www.actionfitoutdoors.com

TRADITIONAL

The Traditional line features 16 stationary fitness products that are versatile and can be used for many different exercises.

FITTECH

The FitTech series features 20 product options as well as our unique resistance elements that allow for a higher level of fitness. ADA accessible options.

ACTIVE ADULT

Active Adult features 13 products and provides a comfortable outdoor fitness solution for the active aging population. ADA accessible options.



TRADITIONAL - UP265 Hurdle





TRADITIONAL - UP262 Body Curl



Ask us how your outdoor fitness park can become a **National Demonstration Site!**



FITTECH - UP184 Push Up



FITTECH - UP164 Cardio Walker



ACTIVE ADULT - UP354 Skill Trainer



ACTIVE ADULT - UP358 Energy & Strength Wheels



OUTDOOR FITNESS PARKS: BEST PRACTICES FOR PROMOTING COMMUNITY HEALTH BY INCREASING PHYSICAL ACTIVITY.

PlayCore, in partnership with noted scholars, developed this guide to inform why outdoor fitness is so beneficial and to help design an outdoor space that delivers a complete workout!





ULTRASHADE™

UltraSite® offers UltraShade™, a wide variety of high-quality engineered shade products that protect from many of Mother Nature's elements. An UltraSite® sales representative will guide you through a simplified process of providing a shade that protects your recreation investment and your community.

Visit www.shadeandshelters.com for more information.



ULTRASHELTER™

UltraSite® offers UltraShelter™, a full spectrum of shelter designs that create community spaces while helping protect patrons from many of nature's elements. An UltraSite® sales representative will guide you through a simplified process of providing a unique shelter that protects your recreation investment and your community. Visit www.shadeandshelters.com for more information.





DERO
A PLAYCORE Company

INNOVATIVE BIKE PARKING AND
COMMUTING SOLUTIONS

Visit www.dero.com for a complete product listing.

- bike racks
- bike shelters
- custom racks
- public bike repair stations



BIKE SHELTERS

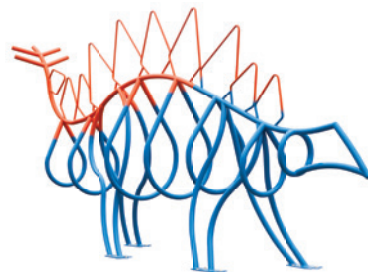

PUBLIC BIKE REPAIR STATIONS

CUSTOM BIKE RACKS



Distributed by: Efficient Amenities



**EFFICIENT
AMENITIES**

Call Us Today.



(855) 884-8387



- Sales and design teams with over 70 years combined experience
- Specializing in I-beam and angle frame stadium seating for all types of spaces including rodeos, racetracks, sporting venues, and schools
- No seating capacity too small or too large – from 10 to 10,000+
- All units can be customized to meet your specific needs or local building code requirements
- Offering warranties that exceed industry standard for peace of mind and confidence in our structures

Visit www.gtgrandstands.com for a complete product listing

ANGLE FRAME BLEACHERS, TIP N' ROLL MODELS, RENOVATIONS



- 25+ years' experience in the commercial spectator seating market
- Expertise in seating for all capacities – small to large
- Renovation options to update non-compliant bleachers to current building and safety codes
- Product line includes angle frame bleachers, team benches, and aluminum picnic tables
- Projects ranging from universities to high schools to sporting complexes across the United States and in countries around the world

Visit www.bleachers.net for a complete product listing





KEEPING SCORE SINCE 1972

- 5-year warranty
- Integrated 2.4GHz wireless – 12 independent channels and 16 independent networks per channel to provide reliable communication for up to 192 separate games at a facility
- Integrated horn
- Easy service access – all digits and electronics are accessed through the front face of the scoreboard.
- Wireless handheld or tabletop controller
- FREE customization options:
- Amber, red, or mixed LED digits
- Enclosures can be customized to match your team colors
- Flexibility to select captions based on your application

Visit www.coloradotime.com for a complete product listing



SCOREBOARD - CM1401

ENCLOSURE COLORS



SCOREBOARD - BB1101



PRODUCT SELECTION GUIDE

PRODUCT #	PRODUCT NAME	PAGE
 BENCHES		
ULTRACOAT BENCHES		
95	Jackson Bench without Back	27
96	Jackson Bench with Back	27
700/800	Straight Bench	25
715/815	Concave/Convex Bench	25
730/830	Concave/Convex Bench	25
932	Mall Bench	21
934	Geometric Mall Bench	21
940	Extra Heavy-Duty Bench with Back	19
940-CL	Buddy Bench	52
940PPS	Portable Preschool Bench	54
942	Extra Heavy-Duty Bench without Back	20
950	Capri Bench	26
954-CL	Lexington Buddy Bench	52
955	Sierra Bench	26
961	Bollard Style Bench	24
962	Bollard Style Bench (Double-Sided)	24
963	Contour Bench	26
965	Contour Bench with Back	22
966	Contour Bench without Back	22
967	Contour Bench Swing	23
970	Cantilevered Bench	20
975	Contour Cantilevered Bench with Back	23
976	Contour Cantilevered Bench without Back	23
NATURAL BENCHES		
20/21	Recycled Bench with Back	67
22	Recycled Bench without Back	67
61	Richmond Bench with Back	59
62	Richmond Bench without Back	59
257	Kid's Size Park Bench	69
940	Extra Heavy-Duty Bench	58
940	Aluminum Bench	68
942	Park & Team Benches without Back	68
952	Recycled Bench without Back	58
964	Charleston Recycled Bench with Back	57
965	Double-Post Contour Park Bench	58
968	Charleston Recycled Bench without Back	57
975	Single-Post Contour Park Bench	59
982	Recycled Bench with Back	57
992/993	Recycled Plastic Bench with Planters	59
PREMIUM BENCHES		
11-12	Hartford Bench	4
43/44	Kensington Bench with/without Back	12
52/53	Huntington Bench with/without Back	8
61/62	Richmond Bench with/without Back (recycled)	9
71/72/73	Madison Bench with Powder Coated Finish	16
71/72/73	Madison Bench with Ipe Wood Finish	16
81	Richmond Bench with Back (steel)	10
82	Richmond Bench without Back (steel)	10
91/92	Hamilton Bench with/without Back	6
93/94	Augusta Bench with/without Back	7
98	Durham Bench without Back	14
99	Durham Bench with Back	14

PRODUCT #	PRODUCT NAME	PAGE
800	Palmetto Bench	17
922	Savannah Bench	5
954	Lexington Bench with Back	15
958	Lexington Bench without Back	15
964	Charleston Bench with Back	13
968	Charleston Bench without Back	13
974	Wilmington Bench	3

 TABLES		
ULTRACOAT TABLES		
158	Heavy-Duty Rectangular Table	32
158H	Heavy-Duty ADA Accessible Table	32
158PS	Rectangular Preschool Table	54
BT158	Heavy-Duty Bolt-Thru Table	32
230	Round Contour Table	33
238	Extra Heavy-Duty Rectangular Table	30
238H	Extra Heavy-Duty 8' ADA Accessible Table	30
238H	Extra Heavy-Duty ADA Shelter Table	31
238HS	Extra Heavy-Duty Single Sided ADA Table	31
238-3	Extra Heavy-Duty Shelter Table	31
238U	Utility Table	35
BT238	Extra Heavy-Duty Bolt-Thru Table	33
239	Rectangular UltraSite® Span Leg Table	36
320/321	Canopy Table	38
337	Heavy-Duty Rectangular Single Pedestal Table	34
338	46" Single Pedestal Table	39
347	Rectangular Dual Pedestal	35
349	Multi Pedestal Table	34
349SU	Multi Pedestal Utility Table	35
350PS/358PS	Portable Preschool Table	55
358	Square, Octagon, & Round Table	29
358	Capri Seating Table	37
358H	Accessible Table	29
360/360L	Pedestal Food Court Table	40
361	Food Court Table	40
362	Ultra Bar Height Table	41
369	Square UltraSite® Span Leg Table	36
501	Canteen Table	37
953	Standard Food Court Chairs	41
956	Tall Food Court Chairs	41

NATURAL TABLES		
24	Recycled Picnic Table	67
26	Recycled Picnic Table	67
63/64	Richmond Table	63
158/158H	Heavy-Duty Aluminum Rectangular Table	68
158	Heavy-Duty Rectangular Table	61
158H	Accessible Table	62
BT158	Bolt-Thru Heavy-Duty Table	62
238	Extra Heavy-Duty Rectangular Table	60
238H	ADA Accessible Table	60
238H	ADA Shelter Table	60
238-3	Shelter Table	61
BT238	Bolt-Thru Extra Heavy-Duty Table	61



PRODUCT #	PRODUCT NAME	PAGE
238/238H	Extra Heavy-Duty Aluminum Rectangular Table	68
337	Single Pedestal Rectangular Table	64
338/338H	48" Single Pedestal Table	64
349/348	Multi-Pedestal Table	63
347	Dual Pedestal Rectangular Table	64
357	46" Preschool Table	69
358	48" Square Table	62
358H	ADA 48" Square Table	63
557	Heavy-Duty 4' Preschool Table	69

PREMIUM TABLES

10-RDHS	Hartford Table	5
40/42	Kensington Table	12
50	Huntington Table with 4 Chairs	8
63/64	Richmond Table	9
364/30	Hamilton Table	6

RECEPTACLES & PLANTERS

ULTRACOAT RECEPTACLES & PLANTERS

12/12AT	Ash Tray & Ash Tray/Trash Combo	49
32RE	Standard Recycle Logo Receptacle	47
32/55	Metal Trash Receptacles	47
41-SD	Kensington Receptacle	43
51-HX	Huntington Receptacle	43
AG-36	Augusta Receptacle	43
AUR	Ash Urn Lid	48
Cable	18" Cable	48
CL-36	Classic Swing Door Receptacle	45
DT-32	Dome Top	48
FTR	Flat Top Lid	48
JK-36	Jackson Receptacle	46
LX-36	Lexington Receptacle	44
LX-72	Dual Lexington Receptacle	44
OX-36	Oxford Receptacle	45
PL	Receptacle Liner	48
RBR	Rain Bonnet Lid	48
RD2418/SQ2418	UltraSite® Planter	49
RD2418-LX	Lexington Planter	49
RT-32	Round Top	48
SM/IG KITS	Receptacle Mounting Kits	47
SD-36FT	Swing Door Receptacle	46

NATURAL RECEPTACLES & PLANTERS

60	Richmond Trash Receptacle	66
682	Galvanized Trash Receptacle	66
AU-32-TRSQ	Ash Urn Lid	66
CH	Charleston Receptacle	65
FT-32-TRSQ	Flat Top Lid	66
RB-32-TRSQ	Rain Bonnet Lid	66
RD2418/SQ2418	Planter	66
SM/IG KITS	Receptacle Mounting Kits	66
TR-32	Round Receptacle	65
TRSQ-32	Square Receptacle	65
TRSQ-20/40/60	Recycling Receptacle	65

PREMIUM RECEPTACLES & PLANTERS

41-SD	Kensington Receptacle	43
51-HX	Huntington Receptacle	43
60	Richmond Trash Receptacle	43

PRODUCT #	PRODUCT NAME	PAGE
AG-36	Augusta Receptacle	7
CH	Charleston Receptacle	65
CL-36	Classic Swing Door Receptacle	3
LX-36	Lexington Receptacle	44
RD2418-LX	Lexington Planter	49
SV-32	Savannah Trash Receptacle	5
SV-R32	Palmetto Trash Receptacle	17

BIKE RACKS

5000S/5000SM	Solstice Rack	78
5020S/5020SM	Horizons Rack	78
5030	Flare Rack	77
5040S/5040SM	Hitch Rack	77
5603/5604/5605	Hanger Rack	76
5800	Contemporary Loop Bike Rack	76
5801/5801D	Inverted Series	76
5821/5821D	Inverted Series	77

ACCESSORIES

7GC	UltraSite® Umbrella	73
100/105	Golf Range Dividers	81
110/115	Golf Bag Stands	81
119S-V20	Foul Ball Poles	81
670	Lantern Hanger	81
758	UltraSite® Umbrella	72
2003/2004	Hampton Series Bollard	74
2013/2014	Modern Bike Bollard	74
2023/2024	Dover Series	74
2603/2604	Newport Series Bollard	75
2613/2813	Rockland Series	75
2624	Shoreline Bollard	75
2633/2833	Classic Bike Bollard	74
2643/2843	Fairfax Bollard	75
2803/2804	Safety Bollard	74
MUV	UltraSite® Umbrella	72

GRILLS

600	Fire Ring	80
612	Multi-Functional Fire Ring	80
616	Rotating Flip-Back Grill	79
620/630	Adjustable Rotating Grill	79
621	Bi-Level Grill	79
627	Commercial Grill	80
632	Rotating Grill	80
650	Dual Grate Grill	79

SHOWCASE

ActionFit	86-87
BarkPark	83-85
Colorado Time Systems	91
Dero	89
GT Grandstands	90
NRS	90
UltraShade®	88
UltraShelter®	88



WARRANTY & TERMS

5-YEAR LIMITED WARRANTY

5-Year Limited Warranty on Thermoplastic coated elements. UltraSite® guarantees all items for one full year to be free of defects in workmanship or materials when installed and maintained properly. We agree to repair or replace any items determined to be defective. Items specifically not covered by this warranty include vandalism, man made or natural disasters, lack of maintenance, normal weathering or wear, and tear due to public abuse.

ORDER INFORMATION

When ordering please include a brief description of all items. Be sure to include colors for UltraCoat® and powder coated surfaces. To assist UltraSite® in entering orders properly, please fax, mail, or e-mail orders on your standard purchase order form. Quotes are good for 30 days.

GSA CONTRACT

GSA pricing is available on several items. Contact our sales department for specific information at 1-800-458-5872.

SPECIFICATIONS

Due to UltraSite's continuous product improvement, we reserve the right to change specifications when necessary without notice.

PRICING

UltraSite® strives to keep pricing as low as possible. However, should we encounter increases in our costs that are too large to absorb, we reserve the right to increase prices without notice.

TERMS

Approved accounts net 30 days. Initial order requires payment in full before shipment. A finance charge of 1-1/2% per month will be applied to all delinquent accounts. We accept:



FREIGHT CHARGES

Terms of sale are F.O.B. factory. UltraSite® will prepay and add the freight to the invoice if requested to do so. All weights are approximate.

DAMAGES

Damages or loss in transit is the responsibility of the carrier, whether visible or concealed. It is the responsibility of the recipient to assure that the order is received complete. Before signing the delivery receipt, inspect the shipment immediately and completely. Note any damages or shortages on the bill of lading. Damage reports must be filed within 5 days. UltraSite® is NOT responsible for damages or loss in transit. Title to all goods passes to the customer at the time of shipment. UltraSite® will assist in filing claims if the freight arrangements were made by UltraSite® at your request.

CANCELLATIONS AND RETURNS

Cancellations are only accepted with pre-approval from UltraSite®. No merchandise shall be returned without a Return Goods Authorization number which is issued by customer service. Any authorized merchandise must be carefully packed and received in saleable condition. A restocking charge of up to 25% will be applied to all returned goods when the error is not the fault of UltraSite®. All returns must be shipped freight prepaid.

NATIONWIDE INSTALLATION

We offer affordable delivery and installation pricing in the continental USA. Any zip code, anytime!

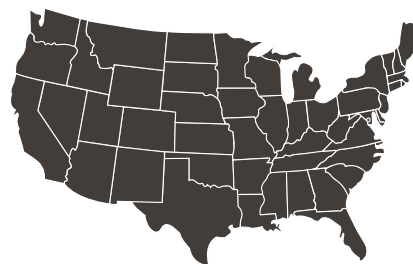

CALL US TO LEARN MORE AT **800-458-5872**
OR VISIT **WWW.ULTRA-SITE.COM**



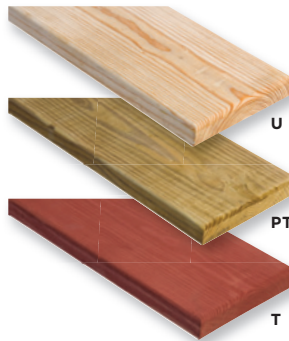

WOOD PLANKS

- 2" x 10" and 2" x 4" sizes
- Rounded edges
- #1 southern yellow pine

(U) UNTREATED

(PT) PRESSURE TREATED

- Environmentally friendly (ACQ)
- Kiln dried before and after treatment

(T) REDWOOD STAIN

- Sealed in redwood stain with wood preservative

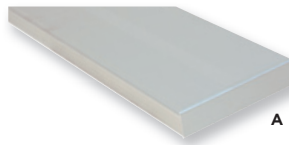
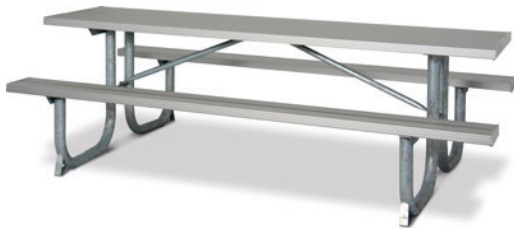

ALUMINUM PLANKS

- 2" x 10" size
- 6063-T6 extruded aluminum alloy

(A) ANODIZED

- Used for table tops, seats, and backs on most products

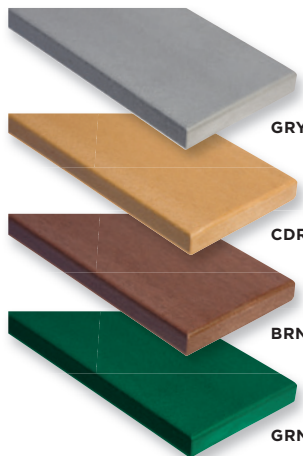

RECYCLED PLANKS

- 2" x 10", 2" x 4", 3" x 4", and 4" x 4" sizes
- Rounded edges
- 100% recycled plastic with color
- Ask about custom color options

(GRY) GRAY

(CDR) CEDAR

(BRN) BROWN

(GRN) GREEN



Most 2" x 10" recycled plastic planking is reinforced with steel flat bars to prevent sagging and warping.



DIE FORMED SEAT PATTERNS

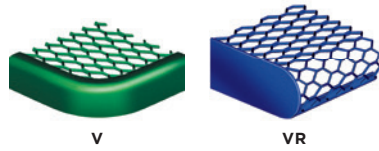

V | DIAMOND

- 9-gauge material
- Expanded metal
- Round corners
- 3/4" opening

VR | DIAMOND ROLLED EDGE

- 9-gauge material
- Expanded metal
- Rolled edge
- 3/4" opening

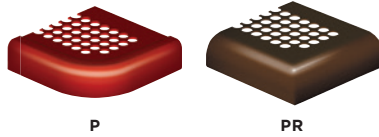

P | PERFORATED

- Perforated metal
- Round corners
- 5/8" diameter punched pattern
- 12-gauge sheet steel

PR | PERFORATED ROLLED EDGE

- Perforated metal
- Rolled corners
- 5/8" diameter punched pattern
- 14-gauge sheet steel



W | WAVE

- 12-gauge sheet steel



FB | FIESTA

- 12-gauge sheet steel



S | SLAT

- 12-gauge sheet steel





ULTRACOAT®
THERMOPLASTIC COLORS

- Superior Adhesion
- Resistance to Cutting and Vandalism
- No Runs or Drips
- Smooth Finish Prevents Mold and Mildew
- Easily Repaired
- UV Protection
- Environmentally Friendly

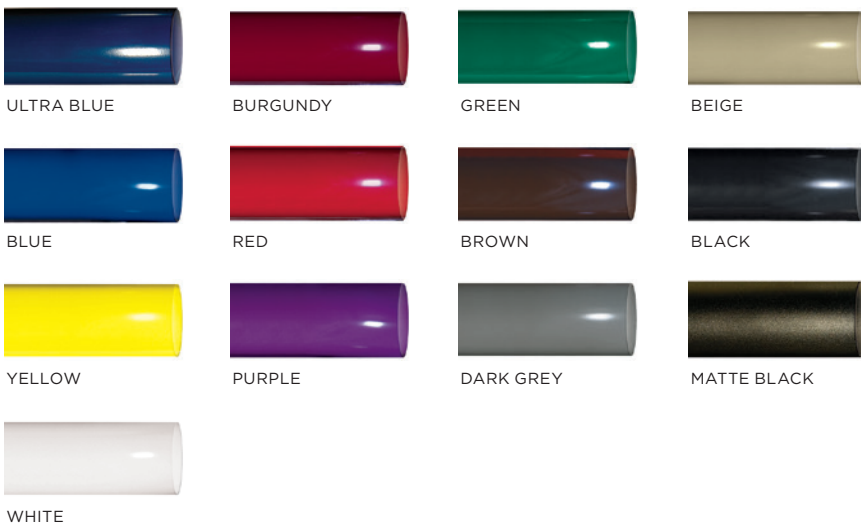

STANDARD
POWDER COAT COLORS

The steel framework used in the UltraCoat® product line delivers one of the industry's most durable protective coatings. UltraSite® further enhances the durability by applying a superior powder coated finish. The process provides five layers of protection from harmful environmental elements, with very little maintenance.

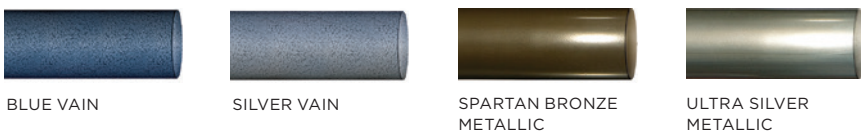

PREMIUM
POWDER COAT COLORS

- Additional upcharge

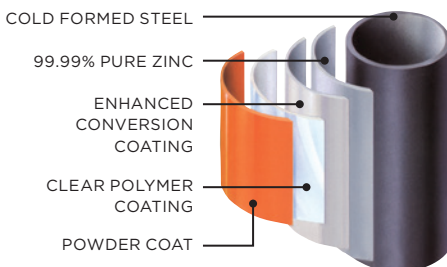

STANDARD
POWDER COAT

- Uniform coating
- Durability
- High-quality
- Attractive finish



HOT-DIP GALVANIZED

- Galvanized both inside and out
- Superior four-layer adhesion bond
- Excellent abrasion resistance
- Provides cathodic protection to the underlying steel
- Increases the useful life of steel





SITE FURNISHINGS | DOG PARKS | SHADE | SHELTER | OUTDOOR FITNESS



1675 Locust Street
Red Bud, IL 62278

 Like us on Facebook



Distributed by: Efficient Amenities



EFFICIENT AMENITIES

Call Us Today.



(855) 884-8387