

**AC** ***Athletic  
Connection***

# RAZOR

See Pages 132-133  
for details and pricing

## Line of Distinction...

More than a decade after the revolutionary Z-Cool® shoulder pads were introduced, evolution has continued with GEAR PRO-TEC's new RAZOR™ shoulder pads. Pushing the limits of shoulder pad design, every detail is focused on elite player performance. Cutting edge design, materials and construction culminate in advanced impact dispersion, dynamic range of motion and flexibility on the lightest weight platform in the industry. **RAZOR is the pinnacle of success in protecting America's finest athletes for over 20 years!**

**GEAR  
PRO-TEC**

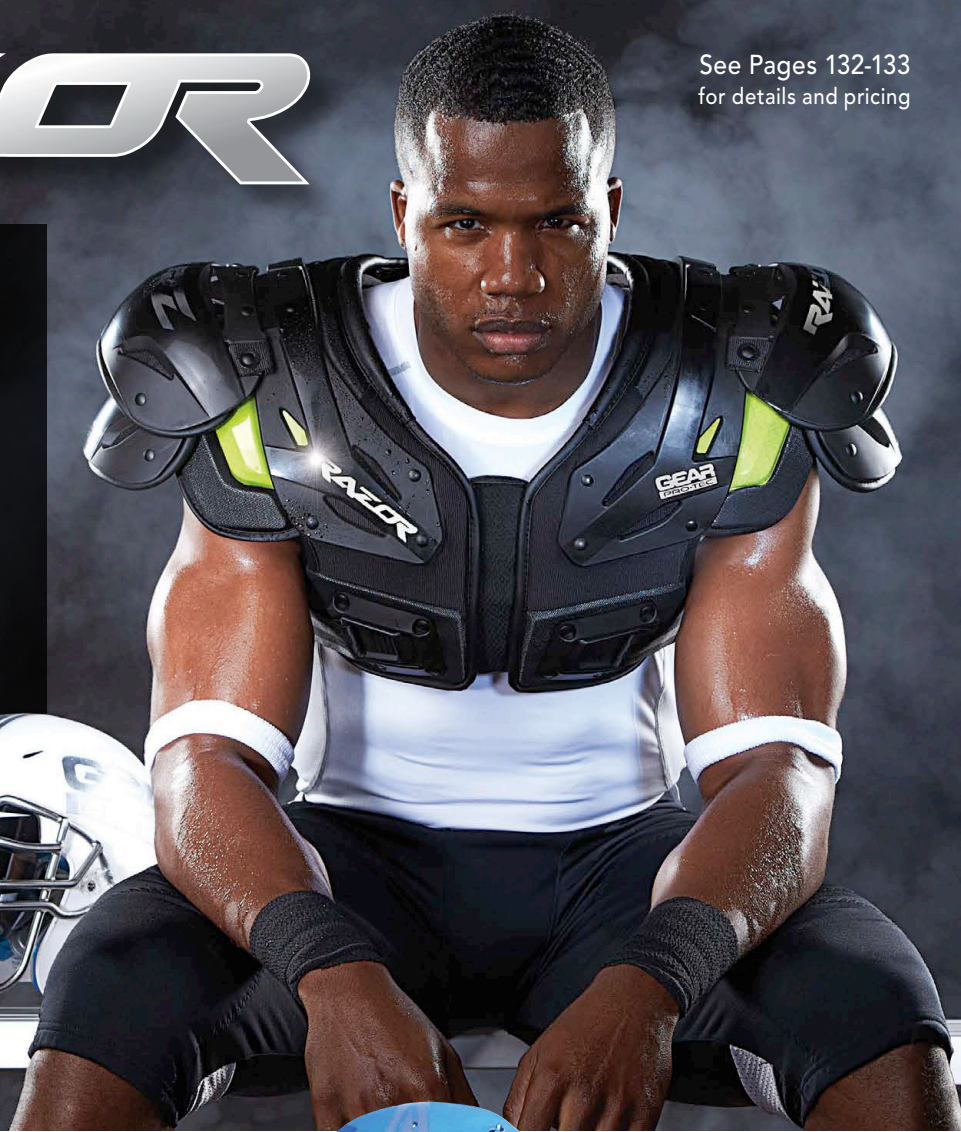

# Z-COOL

SHOULDER PADS

- SUPERIOR IMPACT ABSORPTION
- ANTI-MICROBIAL ARCH FABRIC
- COMPLETELY DRY IN 2-3 HOURS

The GEAR Pro-Tec Z-Cool® pads provide Ultra-Light Protection that's lighter than traditional pads. Our patented moisture transfer technology provides unsurpassed cooling and superior performance.

## 5 MODELS

to specialize by position



**GEAR  
PRO-TEC**

See Pages 134-135  
for details and pricing

# BRANDS YOU DEMAND



## TEAM SPORTS

- BENCHES 4-5
- BLEACHERS 6-15
- BASEBALL/SOFTBALL 16-93
- BASKETBALL 94-115
- FOOTBALL 116-147
- HYDRATION 148-153
- LACROSSE 154-155
- FIELD HOCKEY 156-157
- RACQUET SPORTS 158-173
- SOCCER 174-193
- TRACK & FIELD 194-209
- VOLLEYBALL 210-224
- WRESTLING 225

## STRENGTH & FITNESS

- WEIGHT LIFTING 226-239
- FLOORING 240-241
- CARDIO 242-245
- CORE 246-259
- SPEED & AGILITY 260-264
- ASSESSMENT 265-273
- MATS/GYMNASTICS 274-280
- BOXING 281-283

## FACILITY

- COACHING 284-287
- CONCESSIONS 288-289
- FIELD MARKING 290-293
- FLOOR COVERS 294-295
- GAME TABLES 296-305
- LOCKS & LOCKERS 306-307
- PARKS 308-311
- SCOREBOARDS 312-323
- SPORTS MED 324-328
- TRAFFIC SAFETY 329
- STORAGE 330-333
- WALL PADS 334-336

## PHYSICAL EDUCATION

- PHYSICAL EDUCATION 337-355
- GOLF 356
- ARCHERY 357-359
- INDEX 360-362



### PLAYER'S BENCH WITH SHELF

- Finally, players and coaches have a place for equipment
  - Features 10"W anodized or powder coated planks
  - 20"W rear shelf
  - All aluminum construction.
  - Portable or surface mount (requires drilling holes in framework)
- 5 Year Limited Warranty**

#### ANODIZED ALUMINUM

LENGTH	CODE	PRICE
7.5'	BEPS08	\$519 <sup>22</sup> ★
15'	BEPS15	\$739 <sup>22</sup> ★
21'	BEPS21	\$969 <sup>22</sup> ★
27'	BEPS27	\$1,499 <sup>22</sup> ★

#### POWDER-COATED (SELECT COLOR)

7.5'	BEPS08C	\$569 <sup>22</sup> ★
15'	BEPS15C	\$919 <sup>22</sup> ★
21'	BEPS21C	\$1,319 <sup>22</sup> ★



Shelf space allows place for helmets, scorebooks, caps, water bottles, gloves, etc.

### SCORERS TABLE WITH BENCH

- Table and bench are 7.5' L
  - All aluminum construction
  - Features 10"W anodized or powder coated aluminum seat planks
  - 20"W ribbed aluminum table top.
  - If choosing powder coated, specify color: Forest Green, Navy Blue, Red, Royal Blue
- 5 Year Limited Warranty**

**BEST08**

Natural Aluminum

\$469<sup>22</sup> EA ★

**BEST08C**

Powder Coated

\$519<sup>22</sup> EA ★

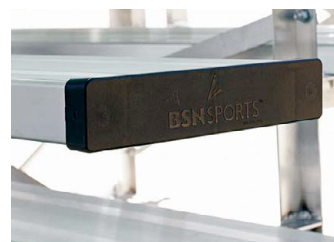

**ADD COLOR TO YOUR BENCHES!**  
SPECIFY COLOR WHEN ORDERING



## PLAYER'S BENCH WITH BACK

THE BEST PLAYER'S BENCHES AVAILABLE...GUARANTEED!

- Seat planks are 10" wide with a ribbed no-slip surface.
- Planks are anodized aluminum and will not rub off on clothing
- Comes with Safety End Caps -No sharp edges to snag clothing or skin
- Legs are constructed of heavy duty commercial grade 2-3/8" O.D. galvanized steel
- Portable models are designed for indoor and outdoor use and come complete with non-marring floor protectors



5 Year Limited Warranty

ANODIZED ALUMINUM				
	IN-GROUND	PORTABLE	SURFACE-MOUNT	
LENGTH	CODE	CODE	CODE	PRICE
7.5'	BEPB08	BEPG08	BEPH08	\$349 <sup>22</sup> ★
15'	BEPB15	BEPG15	BEPH15	\$529 <sup>22</sup> ★
21'	BEPB21	BEPG21	BEPH21	\$674 <sup>22</sup> ★
27'	BEPB27	BEPG27	BEPH27	\$739 <sup>22</sup> ★
POWDER-COATED (SELECT COLOR)				
LENGTH	CODE	CODE	CODE	PRICE
7.5'	BEPB08C	BEPG08C	BEPH08C	\$419 <sup>22</sup> ★
15'	BEPB15C	BEPG15C	BEPH15C	\$679 <sup>22</sup> ★
21'	BEPB21C	BEPG21C	BEPH21C	\$789 <sup>22</sup> ★



15' Anodized Aluminum

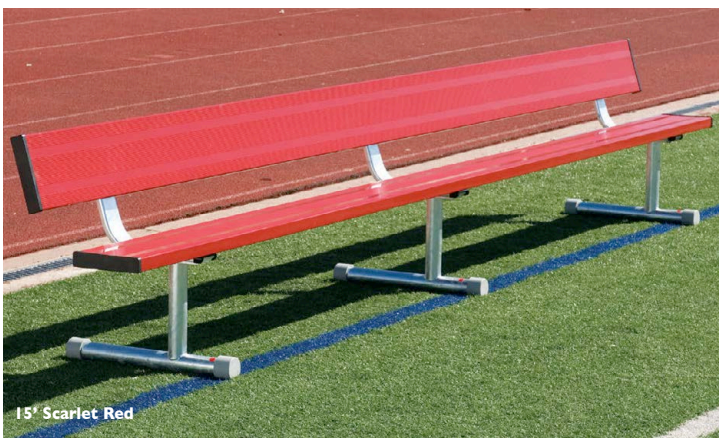

15' Scarlet Red

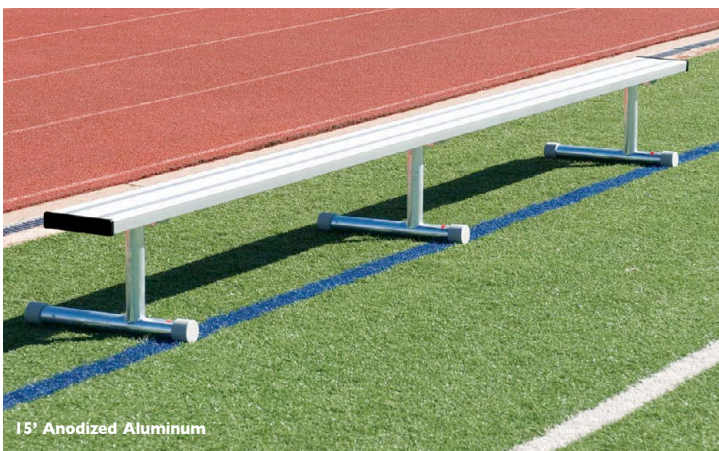

15' Anodized Aluminum

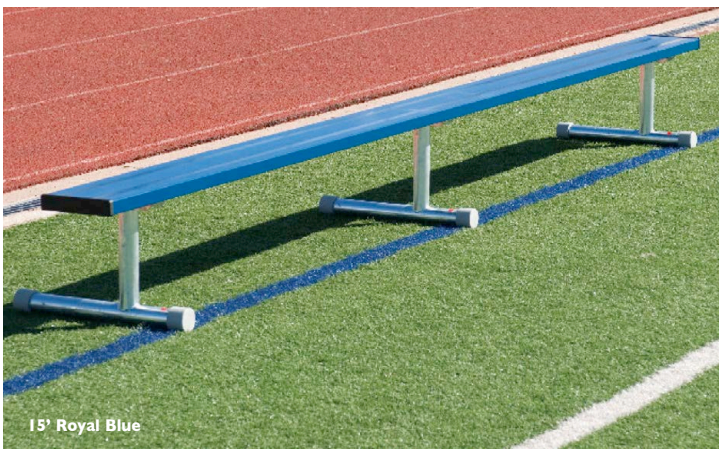

15' Royal Blue

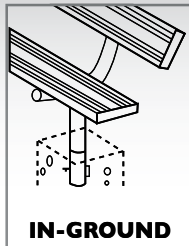

IN-GROUND

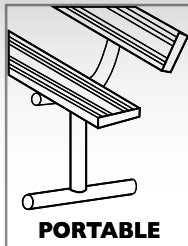

PORTABLE

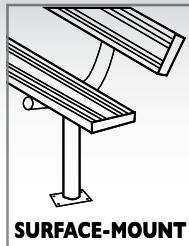

SURFACE-MOUNT

## PLAYER'S BENCH WITHOUT BACK

- Same features as listed above - simply sold without the back rest



5 Year Limited Warranty

ANODIZED ALUMINUM				
	IN-GROUND	PORTABLE	SURFACE-MOUNT	
LENGTH	CODE	CODE	CODE	PRICE
7.5'	BEPD08	BEPD08	BEPE08	\$259 <sup>22</sup> ★
15'	BEPD15	BEPD15	BEPE15	\$319 <sup>22</sup> ★
21'	BEPD21	BEPD21	BEPE21	\$439 <sup>22</sup> ★
27'	BEPD27	N/A	BEPE27	\$499 <sup>22</sup> ★
POWDER-COATED (SELECT COLOR)				
LENGTH	CODE	CODE	CODE	PRICE
7.5'	BEPD08C	BEPD08C	BEPE08C	\$319 <sup>22</sup> ★
15'	BEPD15C	BEPD15C	BEPE15C	\$379 <sup>22</sup> ★
21'	BEPD21C	BEPD21C	BEPE21C	\$489 <sup>22</sup> ★





Preferred, 15'  
Forest Green

NOTE: Bleachers are shipped knocked down.

### LOW RISE BLEACHERS

- Specially designed frames that allows 4 rows of seating without the need for safety fencing.
- Frames are 100% welded aluminum angle
- First row has a seat height of 12"
- Top row has a seat height of 29"
- Seat planks are anodized aluminum or powder coated and won't rub off on clothes!
- Standard models include single foot planks
- Preferred models include double foot planks
- Due to constantly changing specifications, Please check local building and safety codes to ensure bleacher compliance.

**5 Year Limited Warranty**



STANDARD - Single Foot Planks



PREFERRED - Double Foot Planks

### ANODIZED ALUMINUM

ROWS	LXHXD	SEATS	STANDARD	PREFERRED	STANDARD	PRICE	PREFERRED	PRICE
4	7.5'x30"x81"	20	155 lbs	200 lbs	LR0408	\$1,179 <sup>22</sup> ★	LR0408P	\$1,539 <sup>22</sup> ★
4	15'x30"x81"	40	270 lbs	355 lbs	LR0415	\$1,809 <sup>22</sup> ★	LR0415P	\$2,209 <sup>22</sup> ★
4	21'x30"x81"	56	385 lbs	500 lbs	LR0421	\$2,259 <sup>22</sup> ★	LR0421P	\$2,664 <sup>22</sup> ★
4	27'x30"x81"	72	500 lbs	665 lbs	LR0427	\$2,609 <sup>22</sup> ★	LR0427P	\$3,159 <sup>22</sup> ★

### POWDER-COATED (SELECT COLOR)

ROWS	LXHXD	SEATS	STANDARD	PREFERRED	STANDARD	PRICE	PREFERRED	PRICE
4	7.5'x30"x81"	20	155 lbs	200 lbs	LR0408C	\$1,219 <sup>22</sup> ★	LR0408CP	\$1,584 <sup>22</sup> ★
4	15'x30"x81"	40	270 lbs	355 lbs	LR0415C	\$1,899 <sup>22</sup> ★	LR0415CP	\$2,209 <sup>22</sup> ★
4	21'x30"x81"	56	385 lbs	500 lbs	LR0421C	\$2,389 <sup>22</sup> ★	LR0421CP	\$2,844 <sup>22</sup> ★

**We build our benches & bleachers to the highest standards. Listed below are some of the differences by others who may be listing their benches & bleachers as comparable to ours.**

1. Frames - Ours are 100% aluminum angle. Be careful of those quoting "galvanized, steel angle iron" as equal.
2. Seat Planks - Ours are 100% anodized aluminum with a minimum wall thickness of .078 in. A thinner walled unit does not have the strength or support.
3. End Caps - Ours are constructed of fiber reinforced polypropylene. No sharp edges to snag clothing or skin.

4. Indoor Use - Our Tip N' Roll units come with rubber leg protectors so they can be used indoors or out. Be careful of those units using steel vs aluminum. In a "tip-over" fashion, steel could damage your gym floor or cause personal injuries.

**Don't be fooled by a low price. Our manufacturing team has been in this business for 30 years. If you see bids or quotes that "seem too good to be true" - they are. Respectable manufacturers purchase aluminum at the same prices. Anyone offering to deliver product at 30% less is not matching specs.**

**ADD COLOR TO YOUR BLEACHERS!**  
SPECIFY COLOR WHEN ORDERING

NAVY BLUE

SCARLET RED

RAIN SPORTS

RAIN SPORTS



NOTE: Bleachers are shipped knocked down.

Standard 3 Row, 15' Anodized Aluminum



Preferred 2 Row, 15' Royal Blue



Preferred 3 Row, 15' Scarlet

### BLEACHERS WITHOUT FENCING

- Frames are 100% welded aluminum angle
- First row has a seat height of 18"
- Top row has a seat height of 29"
- Planks are 10"W
- Due to constantly changing specifications, please check local building and safety codes to ensure bleacher compliance
- **Standard models include single foot planks**
- **Preferred models include double foot planks**
- **5 Year Limited Warranty**



STANDARD - Single Foot Planks



PREFERRED - Double Foot Planks

ANODIZED ALUMINUM								
ROWS	LXHXD	SEATS	STANDARD	PREFERRED	STANDARD	PRICE	PREFERRED	PRICE
2	15'x24"x36"	20	126 lbs	157 lbs	NB021S	\$954 <sup>22</sup> ★	NB021SP	\$1,089 <sup>22</sup> ★
2	21'x24"x36"	28	170 lbs	213 lbs	NB022I	\$1,269 <sup>22</sup> ★	NB022IP	\$1,404 <sup>22</sup> ★
3	15'x30"x60"	30	203 lbs	263 lbs	NB031S	\$1,309 <sup>22</sup> ★	NB031SP	\$1,449 <sup>22</sup> ★
3	21'x30"x60"	42	280 lbs	360 lbs	NB032I	\$1,584 <sup>22</sup> ★	NB032IP	\$1,809 <sup>22</sup> ★
3	27'x30"x60"	54	367 lbs	476 lbs	NB0327	\$2,039 <sup>22</sup> ★	NB0327P	\$2,259 <sup>22</sup> ★
POWDER-COATED (SELECT COLOR)								
ROWS	LXHXD	SEATS	STANDARD	PREFERRED	STANDARD	PRICE	PREFERRED	PRICE
2	15'x24"x36"	20	126 lbs	157 lbs	NB0215C	\$1,209 <sup>22</sup> ★	NB0215CP	\$1,379 <sup>22</sup> ★
2	21'x24"x36"	28	170 lbs	213 lbs	NB0221C	\$1,359 <sup>22</sup> ★	NB0221CP	\$1,494 <sup>22</sup> ★
3	15'x30"x60"	30	203 lbs	263 lbs	NB0315C	\$1,404 <sup>22</sup> ★	NB0315CP	\$1,539 <sup>22</sup> ★
3	21'x30"x60"	42	280 lbs	360 lbs	NB0321C	\$1,709 <sup>22</sup> ★	NB0321CP	\$1,989 <sup>22</sup> ★

FOREST GREEN

ROYAL BLUE





**5 Row, 15' Anodized Aluminum with Chain-link Fencing**



**STANDARD - Single Foot Planks**



NOTE: Bleachers are shipped knocked down.

### **BLEACHERS WITH FENCING**

- Frames are 100% welded aluminum angle
- Planks are 10"W
- Seat planks are anodized aluminum or powder coated and won't rub off on clothes
- Bleachers include guardrail system and riser boards on rows 4 and above
- Colored bleachers include colored seat planks only
- Planks include safety end caps - no sharp edges to snag clothes or skin
- Due to constantly changing specifications, please check local building and safety codes to ensure compliance

**5 Year Limited Warranty**



### **ANODIZED ALUMINUM**

ROWS	LENGTH	SEATS	WEIGHT	CHAIN-LINK	PRICE	VERTICAL PICKET	PRICE
4	15'	40	596 lbs	<b>NB0415</b>	\$2,799 <sup>22</sup> ★	<b>NB0415V</b>	\$3,429 <sup>22</sup> ★
4	21'	56	777 lbs	<b>NB0421</b>	\$3,339 <sup>22</sup> ★	<b>NB0421V</b>	\$4,124 <sup>22</sup> ★
4	27'	72	970 lbs	<b>NB0427</b>	\$3,999 <sup>22</sup> ★	<b>NB0427V</b>	\$4,959 <sup>22</sup> ★
5	15'	50	749 lbs	<b>NB0515</b>	\$3,469 <sup>22</sup> ★	<b>NB0515V</b>	\$4,149 <sup>22</sup> ★
5	21'	70	992 lbs	<b>NB0521</b>	\$4,379 <sup>22</sup> ★	<b>NB0521V</b>	\$5,139 <sup>22</sup> ★
5	27'	90	1250 lbs	<b>NB0527</b>	\$5,364 <sup>22</sup> ★	<b>NB0527V</b>	\$6,264 <sup>22</sup> ★

### **POWDER-COATED (SELECT COLOR)**

ROWS	LENGTH	SEATS	WEIGHT	CHAIN-LINK	PRICE	VERTICAL PICKET	PRICE
4	15'	40	596 lbs	<b>NB0415C</b>	\$3,024 <sup>22</sup> ★	<b>NB0415CV</b>	\$3,654 <sup>22</sup> ★
4	21'	56	777 lbs	<b>NB0421C</b>	\$3,519 <sup>22</sup> ★	<b>NB0421CV</b>	\$4,284 <sup>22</sup> ★
5	15'	50	749 lbs	<b>NB0515C</b>	\$3,789 <sup>22</sup> ★	<b>NB0515CV</b>	\$4,464 <sup>22</sup> ★
5	21'	70	992 lbs	<b>NB0521C</b>	\$4,689 <sup>22</sup> ★	<b>NB0521CV</b>	\$5,409 <sup>22</sup> ★

**ADD COLOR TO YOUR BLEACHERS!**  
SPECIFY COLOR WHEN ORDERING

NAVY BLUE

SCARLET RED







4 Row, 15' Scarlet Red with Vertical Pickets



NOTE: Bleachers are shipped knocked down.



PREFERRED - Double Foot Planks

### PREFERRED BLEACHERS WITH FENCING

- Frames are 100% welded aluminum angle
- Seat planks are anodized or powder coated (where applicable)
- Bleachers include guardrail system and riser boards on rows 4 and above
- Chain-link fencing is 9 gauge steel
- Available in 4 & 5 row models
- Available in 15', 21' and 27' long
- Due to constantly changing specifications, please check local building and safety codes to ensure compliance.

5 Year Limited Warranty

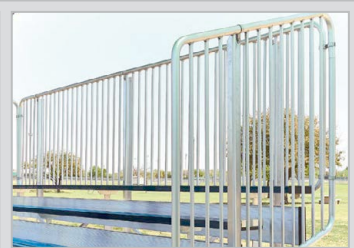

### ANODIZED ALUMINUM

ROWS	LENGTH	SEATS	WEIGHT	CHAIN-LINK	PRICE	VERTICAL PICKET	PRICE
4	15'	40	616 lbs	NB0415P	\$3,069 <sup>22</sup> ★	NB0415VP	\$3,744 <sup>22</sup> ★
4	21'	56	820 lbs	NB0421P	\$3,699 <sup>22</sup> ★	NB0421VP	\$4,959 <sup>22</sup> ★
4	27'	72	1038 lbs	NB0427P	\$4,509 <sup>22</sup> ★	NB0427VP	\$5,184 <sup>22</sup> ★
5	15'	50	769 lbs	NB0515P	\$3,879 <sup>22</sup> ★	NB0515VP	\$4,554 <sup>22</sup> ★
5	21'	70	1032 lbs	NB0521P	\$4,959 <sup>22</sup> ★	NB0521VP	\$5,724 <sup>22</sup> ★
5	27'	90	1316 lbs	NB0527P	\$5,899 <sup>22</sup> ★	NB0527VP	\$6,799 <sup>22</sup> ★

### POWDER-COATED (SELECT COLOR)

ROWS	LENGTH	SEATS	WEIGHT	CHAIN-LINK	PRICE	VERTICAL PICKET	PRICE
4	15'	40	616 lbs	NB0415CP	\$3,429 <sup>22</sup> ★	NB0415CVP	\$5,009 <sup>22</sup> ★
4	21'	56	820 lbs	NB0421CP	\$3,879 <sup>22</sup> ★	NB0421CVP	\$4,644 <sup>22</sup> ★
5	15'	50	769 lbs	NB0515CP	\$4,149 <sup>22</sup> ★	NB0515CVP	\$4,824 <sup>22</sup> ★
5	21'	70	1032 lbs	NB0521CP	\$5,184 <sup>22</sup> ★	NB0521CVP	\$5,949 <sup>22</sup> ★

FOREST GREEN

ROYAL BLUE





### TIP N' ROLL BLEACHERS

- Tip N' Roll bleachers are perfect for auxiliary seating requirements
  - Unit easily tips up on its casters for convenient storage
  - Frames are 100% welded aluminum angle
  - Seat planks are either anodized or powder coated (where applicable)
  - High grade swivel casters & rubber foot pads will not mar your floors
  - Due to constantly changing specifications, please check local building and safety codes to ensure compliance
  - **Standard models include single foot planks**
  - **Preferred models include double foot planks**
  - **WARNING:** These lightweight units are easily tipped up for rolling by any responsible adult. However, if tipped up outdoors, extreme caution should be taken in windy conditions. Multiple adults may be required to control the unit
- 5 Year Limited Warranty**



STANDARD - Single Foot Planks



PREFERRED - Double Foot Planks

#### ANODIZED ALUMINUM

ROWS	LXHXD	SEATS	STANDARD	PREFERRED	STANDARD	PRICE	PREFERRED	PRICE
2	7.5'x24"x36"	10	72 lbs	89 lbs	TR0208	\$684 <sup>22</sup> ★	TR0208P	\$824 <sup>22</sup> ★
2	15'x24"x36"	20	131 lbs	162 lbs	TR0215	\$1,044 <sup>22</sup> ★	TR0215P	\$1,179 <sup>22</sup> ★
2	21'x24"x36"	28	175 lbs	219 lbs	TR0221	\$1,404 <sup>22</sup> ★	TR0221P	\$1,584 <sup>22</sup> ★
3	7.5'x30"x60"	15	116 lbs	133 lbs	TR0308	\$999 <sup>22</sup> ★	TR0308P	\$1,089 <sup>22</sup> ★
3	15'x30"x60"	30	207 lbs	252 lbs	TR0315	\$1,309 <sup>22</sup> ★	TR0315P	\$1,539 <sup>22</sup> ★
3	21'x30"x60"	42	265 lbs	345 lbs	TR0321	\$1,719 <sup>22</sup> ★	TR0321P	\$2,034 <sup>22</sup> ★
3	27'x30"x60"	54	352 lbs	N/A	TR0327	\$2,259 <sup>22</sup> ★	N/A	N/A
4*	7.5'x30"x81"	20	146 lbs	190 lbs	TR0408	\$1,269 <sup>22</sup> ★	TR0408P	\$1,629 <sup>22</sup> ★
4*	15'x30"x81"	40	295 lbs	384 lbs	TR0415	\$1,899 <sup>22</sup> ★	TR0415P	\$2,304 <sup>22</sup> ★
4*	21'x30"x81"	56	398 lbs	524 lbs	TR0421	\$2,299 <sup>22</sup> ★	TR0421P	\$2,759 <sup>22</sup> ★

#### POWDER-COATED - SELECT YOUR COLOR

ROWS	LENGTH	SEATS	STANDARD	PREFERRED	STANDARD	PRICE	PREFERRED	PRICE
2	7.5'x24"x36"	10	72 lbs	89 lbs	TR0208C	\$759 <sup>22</sup> ★	TR0208CP	\$855 <sup>22</sup> ★
2	15'x24"x36"	20	131 lbs	162 lbs	TR0215C	\$1,089 <sup>22</sup> ★	TR0215CP	\$1,269 <sup>22</sup> ★
2	21'x24"x36"	28	175 lbs	219 lbs	TR0221C	\$1,494 <sup>22</sup> ★	TR0221CP	\$1,719 <sup>22</sup> ★
3	7.5'x30"x60"	15	116 lbs	133 lbs	TR0308C	\$1,089 <sup>22</sup> ★	TR0308CP	\$1,224 <sup>22</sup> ★
3	15'x30"x60"	30	207 lbs	252 lbs	TR0315C	\$1,449 <sup>22</sup> ★	TR0315CP	\$1,669 <sup>22</sup> ★
3	21'x30"x60"	42	265 lbs	345 lbs	TR0321C	\$1,854 <sup>22</sup> ★	TR0321CP	\$2,169 <sup>22</sup> ★
4*	7.5'x30"x81"	20	146 lbs	190 lbs	TR0408C	\$1,359 <sup>22</sup> ★	TR0408CP	\$1,674 <sup>22</sup> ★
4*	15'x30"x81"	40	295 lbs	384 lbs	TR0415C	\$1,989 <sup>22</sup> ★	TR0415CP	\$2,404 <sup>22</sup> ★
4*	21'x30"x81"	56	398 lbs	524 lbs	TR0421C	\$2,484 <sup>22</sup> ★	TR0421CP	\$2,939 <sup>22</sup> ★

\*4 Row models feature low rise framework. See page 6 for full details.

**ADD COLOR TO YOUR  
TIP N' ROLL BLEACHERS!**  
SPECIFY COLOR WHEN ORDERING

NAVY BLUE

SCARLET RED

FOREST GREEN

ROYAL BLUE



**5 ROWS X 15' LONG WITH 2 HANDICAP**  
Shown with Vertical Picket Guardrail System

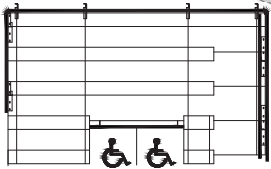
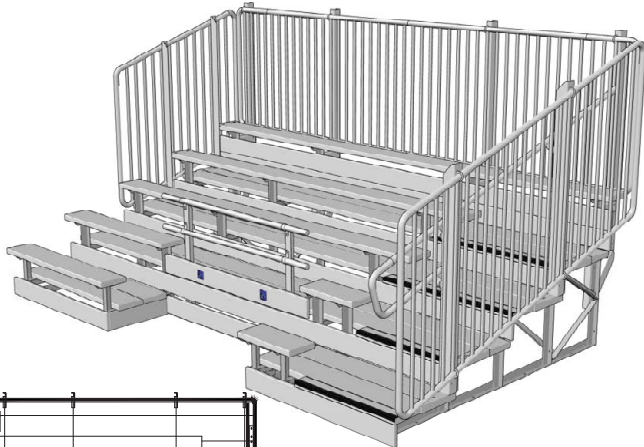

**5 ROWS X 27' LONG WITH 4 HANDICAP**  
Shown with Vertical Picket Guardrail System

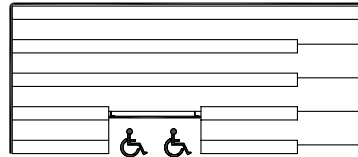
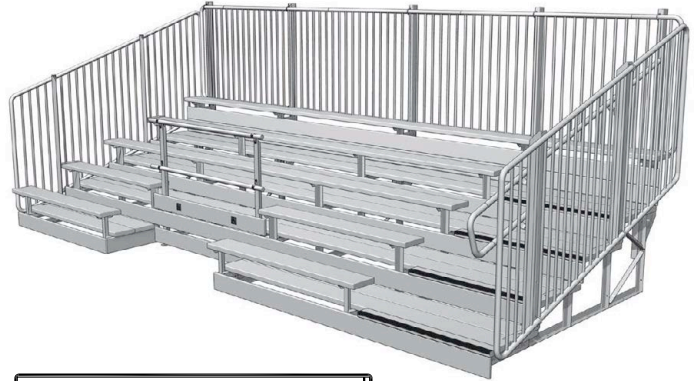

**5 ROWS X 19'-6" LONG WITH 2 HANDICAP**  
Shown with Vertical Picket Guardrail System

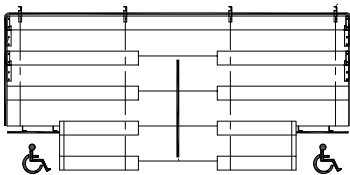
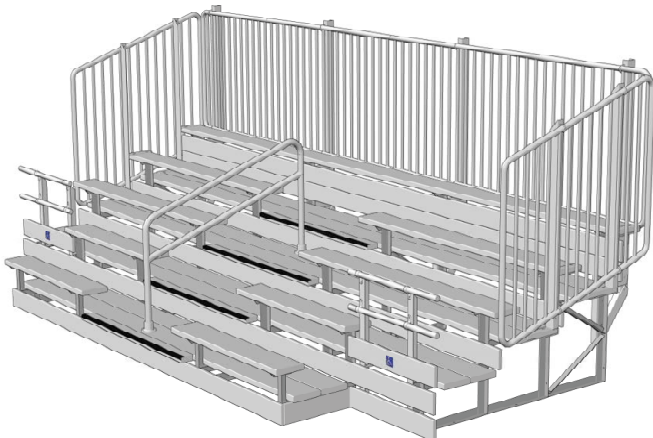

**5 ROWS X 27' LONG WITH 4 HANDICAP**  
Shown with Vertical Picket Guardrail System

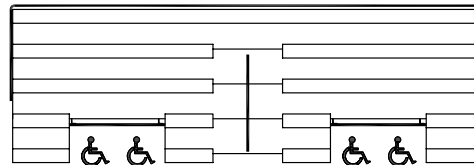
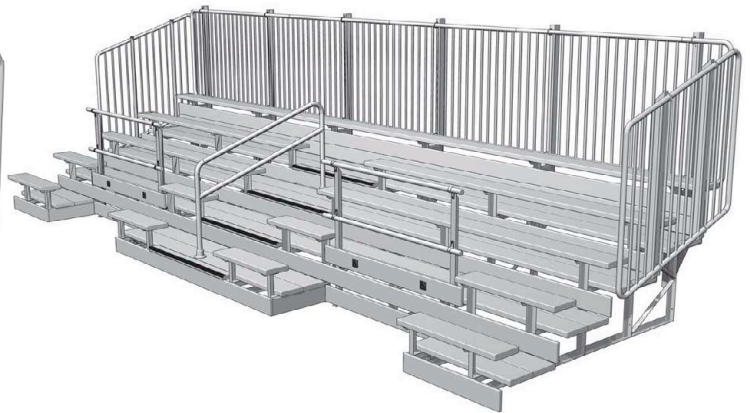

**DELUXE ADA BLEACHERS**

- All aluminum deluxe ADA bleachers
- Single seat planks
- Double foot planks, riser closure on all rows and vertical aisle with handrails
- Choose between chain-link and vertical picket guardrails

NOTE: Bleachers are shipped knockdown and require complete assembly on site.

ROWS	LENGTH	SEATS	WEIGHT	GUARD RAIL	CODE	PRICE	DELIVERY
5	15'	34 + 2 Handicap	1,050 lbs.	Chain-link	1383873	\$6,199 <sup>22</sup> ★	
5	15'	34 + 2 Handicap	1,111 lbs.	Vertical Picket	1383874	\$7,149 <sup>22</sup> ★	
5	19'-6"	45 + 2 Handicap	1,305 lbs.	Chain-link	1383875	\$7,324 <sup>22</sup> ★	
5	19'-6"	45 + 2 Handicap	1,353 lbs.	Vertical Picket	1383876	\$8,174 <sup>22</sup> ★	
5	21'	48 + 2 Handicap	1,404 lbs.	Chain-link	1301045	\$7,189 <sup>22</sup> ★	
5	21'	48 + 2 Handicap	1,455 lbs.	Vertical Picket	1301052	\$8,449 <sup>22</sup> ★	
5	27'	58 + 4 Handicap	1,854 lbs.	Chain-link	1301069	\$9,374 <sup>22</sup> ★	
5	27'	58 + 4 Handicap	1,912 lbs.	Vertical Picket	1301076	\$10,509 <sup>22</sup> ★	



Please allow 3 to 4 weeks for delivery.

**VIP SERIES BLEACHERS**

- Frames are 100% welded aluminum angle
- 2" x 10" anodized aluminum seat planks
- 2 - 2" x 10" foot planks on every row
- 2" x 10" riser on top row and 1" x 6" risers on all other rows
- 2" 9 gauge fence railing on all chain-link models
- 4.5' aisle with aluminum hand rail on select models

**5 Year Limited Warranty**

ROWS	LENGTH	SEATS	RAILING	AISLE	CHAIN-LINK	VERTICAL PICKET
5	21'	58	✓	✓	1049185 \$6,299 <sup>22</sup>	1196542 \$7,499 <sup>22</sup>
8	15'	80	✓		1135190 \$7,199 <sup>22</sup>	1196559 \$8,699 <sup>22</sup>
8	21'	112	✓		1135206 \$9,199 <sup>22</sup>	1196566 \$10,899 <sup>22</sup>
8	21'	91	✓	✓	1135220 \$10,399 <sup>22</sup>	1196580 \$11,999 <sup>22</sup>
8	27'	144	✓		1135213 \$11,499 <sup>22</sup>	1196573 \$13,399 <sup>22</sup>
8	27'	116	✓	✓	1135237 \$12,699 <sup>22</sup>	1196597 \$14,499 <sup>22</sup>
10	15'	100	✓		1135244 \$9,099 <sup>22</sup>	1196603 \$10,799 <sup>22</sup>
10	21'	140	✓		1135251 \$11,399 <sup>22</sup>	1196610 \$13,499 <sup>22</sup>
10	21'	113	✓	✓	1135275 \$13,099 <sup>22</sup>	1196634 \$14,899 <sup>22</sup>
10	27'	180	✓		1135268 \$14,699 <sup>22</sup>	1196627 \$16,599 <sup>22</sup>
10	27'	144	✓	✓	1135282 \$15,699 <sup>22</sup>	1196641 \$17,799 <sup>22</sup>

**CALL FOR PRICING!****ADA STADIUM SEATING**

- The chart below gives specifications for some popular designs.
- Bleachers have galvanized steel frames and meet I.B.C. 2000 Building Code Requirements
- Elevated bleachers include 63" wide front walkway and 36" high elevation
- Actual shipping charges apply
- Please call for pricing and further details

ROWS	SEATS	LENGTH	DEPTH	HEIGHT	CODE	DELIVERY
10	284 + 5 Handicap	55' - 6"	25' - 6"	14' - 3"	1383877	
10	497 + 6 Handicap	91' - 6"	25' - 6"	14' - 3"	1383878	
10	740 + 8 Handicap	133' - 6"	25' - 6"	14' - 3"	1383879	
10	983 + 10 Handicap	175' - 6"	25' - 6"	14' - 3"	1383880	
15	495 + 6 Handicap	61' - 6"	17' - 7"	17' - 7"	1383881	
15	749 + 7 Handicap	91' - 6"	17' - 7"	17' - 7"	1383882	
15	1,003 + 8 Handicap	121' - 6"	17' - 7"	17' - 7"	1383883	
15	1,493 + 10 Handicap	175' - 6"	17' - 7"	17' - 7"	1383884	

## CUSTOM SPECTATOR SEATING



**Permanent Grandstands**

BLEACHERS



GT GRANDSTANDS™

A PLAYCORE Company

**Custom Grandstands and bleachers built to meet your needs.**

- **Permanent Grandstands**
- **Existing Structure Renovations**
- **Portable Angle Frame Bleachers**

### Portable Angle Bleachers



### Existing Structure Renovations

**BEFORE**



**AFTER**

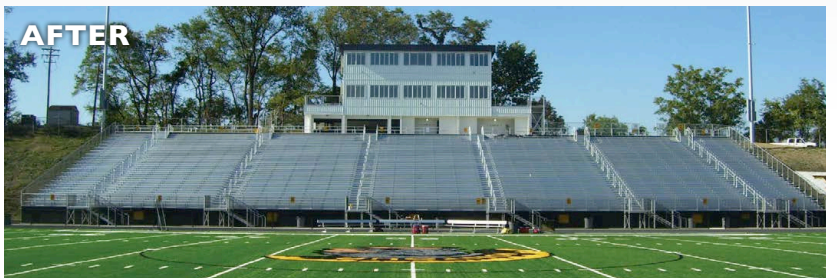



**5 Row Supreme Bleachers include Vertical Picket Guardrails**



**30" Spacing**  
(Typical Bleacher is 24" Spacing)

**Includes 12" wide seat plank vs. 10"**

### **SUPREME BLEACHERS**

- 20% More Leg Room (30" row spacing instead of standard 24")
  - Wider Seat Planks for Added Comfort (12" wide instead of 10")
  - Supreme Bleachers feature welded aluminum frames, vertical picket guardrail system & 3 foot planks per row (note: 3 row Supreme bleacher does not have a guardrail system)
  - Comes with or without vertical aisle and handrail
  - 3 row bleachers are 70" deep
  - 5 row bleachers are 130" deep
- 3 Year Limited Warranty**

#### **WITHOUT VERTICAL AISLES**

ROWS	LENGTH	SEATS	WEIGHT	CODE	PRICE
3	15'	30	500 lbs	1274851	\$2,299 <sup>22</sup>
3	21'	42	553 lbs	1274868	\$3,099 <sup>22</sup>
3	27'	54	750 lbs	1274875	\$3,699 <sup>22</sup>
5	15'	50	1300 lbs	1274912	\$7,799 <sup>22</sup>
5	21'	70	1521 lbs	1274882	\$6,799 <sup>22</sup>
5	27'	90	2055 lbs	1274929	\$8,699 <sup>22</sup>

#### **WITH VERTICAL AISLES**

ROWS	LENGTH	SEATS	STANDARD	STANDARD	PRICE
5	15'	42	2490 lbs	1274899	\$7,999 <sup>22</sup>
5	21'	58	2990 lbs	1274936	\$11,299 <sup>22</sup>
5	27'	74	3940 lbs	1274905	\$10,299 <sup>22</sup>

Note: Bleachers are shipped knockdown and require complete assembly on site.



### **FIRST CLASS BLEACHERS**

- First Class Bleachers feature welded aluminum angle frames, vertical aisle with handrail, vertical picket guardrail system.
  - 4 row bleachers are 130" deep
  - 8 row bleachers are 276" deep
  - 50% More Leg Room (36" row spacing instead of 24")
  - Superior Sight Lines (14" rise instead of standard 8")
  - Backrests on Every Row (for maximum comfort)
  - Wider Seat Planks for Added Comfort (12" wide seat planks instead of 10")
  - Actual shipping charges apply
- 3 Year Limited Warranty**

First Class Bleachers feature welded aluminum angle frames, vertical aisle with handrail, vertical picket guardrail system. 4 row bleachers are 132" deep. 8 row bleachers are 276" deep. **Actual shipping charges apply.**

#### **FIRST CLASS BLEACHERS**

ROWS	LENGTH	SEATS	WEIGHT	CODE	PRICE
4	19'6"	43	1550 lbs	K72481	\$8,399 <sup>22</sup>
4	25'6"	59	2050 lbs	1274950	\$11,300 <sup>22</sup>
4	31'6"	75	2400 lbs	1275100	\$12,699 <sup>22</sup>
8	19'6"	83	3220 lbs	1275117	\$17,299 <sup>22</sup>
8	25'6"	115	4200 lbs	1275124	\$21,999 <sup>22</sup>
8	31'6"	147	4900 lbs	1275131	\$24,999 <sup>22</sup>

Note: Bleachers are shipped knockdown and require complete assembly on site.

#### **BLEACHER SIGHT LINE**



**STANDARD BLEACHER**

**FIRST CLASS BLEACHER**



## TRANSPORTABLE PREFERRED BLEACHERS

- Designed to be moved around your grounds (5 mph max)
  - Each transportable bleacher is fitted with a galvanized steel horizontal lifting brace, and has extra bracing to stabilize the bleacher during transport.
  - Transportable bleachers come with ground sills and require the purchase of one transport kit which can move several bleachers, one at a time
  - Both Preferred and Deluxe Bleachers feature double foot planks on all rows w/single seat planks, riser closure on rows 4 and up with chain-link guardrail starting at row 3.
  - Deluxe Bleachers also include the added benefit of a handrail
- 5 Year Limited Warranty**

PREFERRED DESIGN BLEACHERS 					
ROWS	LENGTH	SEATS	WEIGHT	CODE	PRICE
5	15'	50	1028 lbs	NBT0515P	\$4,599 <sup>22</sup>
5	21'	70	1446 lbs	NBT0521P	\$6,249 <sup>22</sup>
5	24'	80	1559 lbs	NBT0524P	\$6,699 <sup>22</sup>
10	15'	100	2161 lbs	NBT1015P	\$9,449 <sup>22</sup>
10	21'	140	3068 lbs	NBT1021P	\$12,449 <sup>22</sup>
10	24'	160	3285 lbs	NBT1024P	\$13,249 <sup>22</sup>

## TRANSPORT KIT (REQUIRED)

**5 Year Limited Warranty**

- NBTK5 5 Row Transport Kit - Required with 5 row Transportable Bleachers \$1,099<sup>22</sup> EA 
- NBTK10 10 Row Transport Kit - Required with 10 Row Transportable Bleachers \$3,899<sup>22</sup> EA 



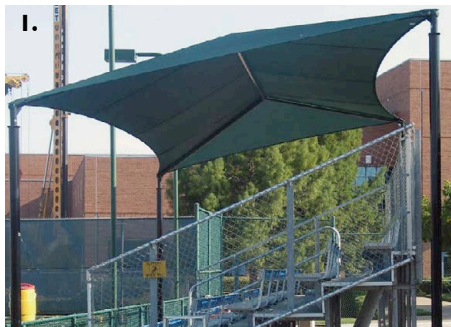

DELUXE DESIGN BLEACHERS 					
ROWS	LENGTH	SEATS	WEIGHT	CODE	PRICE
5	21'	58	1519 lbs	NBT0521D	\$6,849 <sup>22</sup>
5	24'	68	1641 lbs	NBT0524D	\$7,299 <sup>22</sup>
10	21'	113	3193 lbs	NBT1021D	\$13,549 <sup>22</sup>
10	24'	133	3422 lbs	NBT1024D	\$14,399 <sup>22</sup>





## BLEACHER COVERS

- Perfect for providing safety and comfort by protecting spectators from foul balls and excessive sunlight.
- All units feature durable black powder-coated steel posts designed for permanent installation
- Exclusive Shadsure® cloth covering to block over 90% of harmful UV rays
- Professional installation recommended
- All structures have a 90 MPH windload rating and 5 lb. snowload rating (call for details on higher ratings)
- California public schools must call for DSA information.
- Please allow 6 to 8 weeks for delivery
- All covers carry a 10 year limited warranty with the exception of Red cover which carries a 3 year limited warranty.



### 1) Slanted Bleacher Covers Front is 10'H and Rear is 13'H

1100662	18' x 26'	\$6,199 <sup>22</sup> EA	
1100716	20' x 26'	\$6,699 <sup>22</sup> EA	

### 2) Standard Bleacher Covers

1100617	10'H x 15' x 15'	\$3,899 <sup>22</sup> EA	
1100518	10'H x 18' x 27'	\$4,499 <sup>22</sup> EA	
1100563	12'H x 18' x 36'	\$9,199 <sup>22</sup> EA	

### 3) Single Post Pyramid

1100860	10' x 10'	\$2,499 <sup>22</sup> EA	
1100914	12' x 12'	\$2,699 <sup>22</sup> EA	
1100969	14' x 14'	\$3,099 <sup>22</sup> EA	

## COLOR OPTIONS

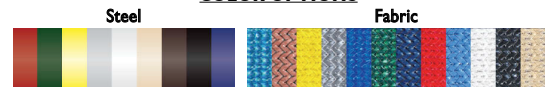

## CANOPY WALL PANEL KIT

- Includes 3 solid walls and 1 zippered entrance wall - all white

1248289 \$169<sup>22</sup> SET



## WEIGHT PLATES FOR QUIK® SHADE

- Secure your canopy against light winds with these 5 lb. weight plates

20018222 \$89<sup>22</sup> SET OF 4



## QUIK® SHADE CANOPY

- One-piece, fully assembled, commercial grade, powder coated frame
- 100% UV protection 300 denier polyester top
- Multiple height adjustments
- Comfortably shades 8-10 people
- Wheeled carry bag included
- Weighs only 50 lbs.

1334586 10' x 10' - White \$259<sup>22</sup> EA



## SHADE CANOPY CART

- Lightweight two wheel cart transports heavy canopies with ease
- Fits in your SUV or truck
- Adjustable straps to fit various size canopies
- Constructed of 1" Silver Powder Coated steel tube with 8 1/2" wheels
- Weight: 8 1/3 lbs.

1372016 42"H x 16"W x 8 1/2"D \$79<sup>22</sup> EA ★

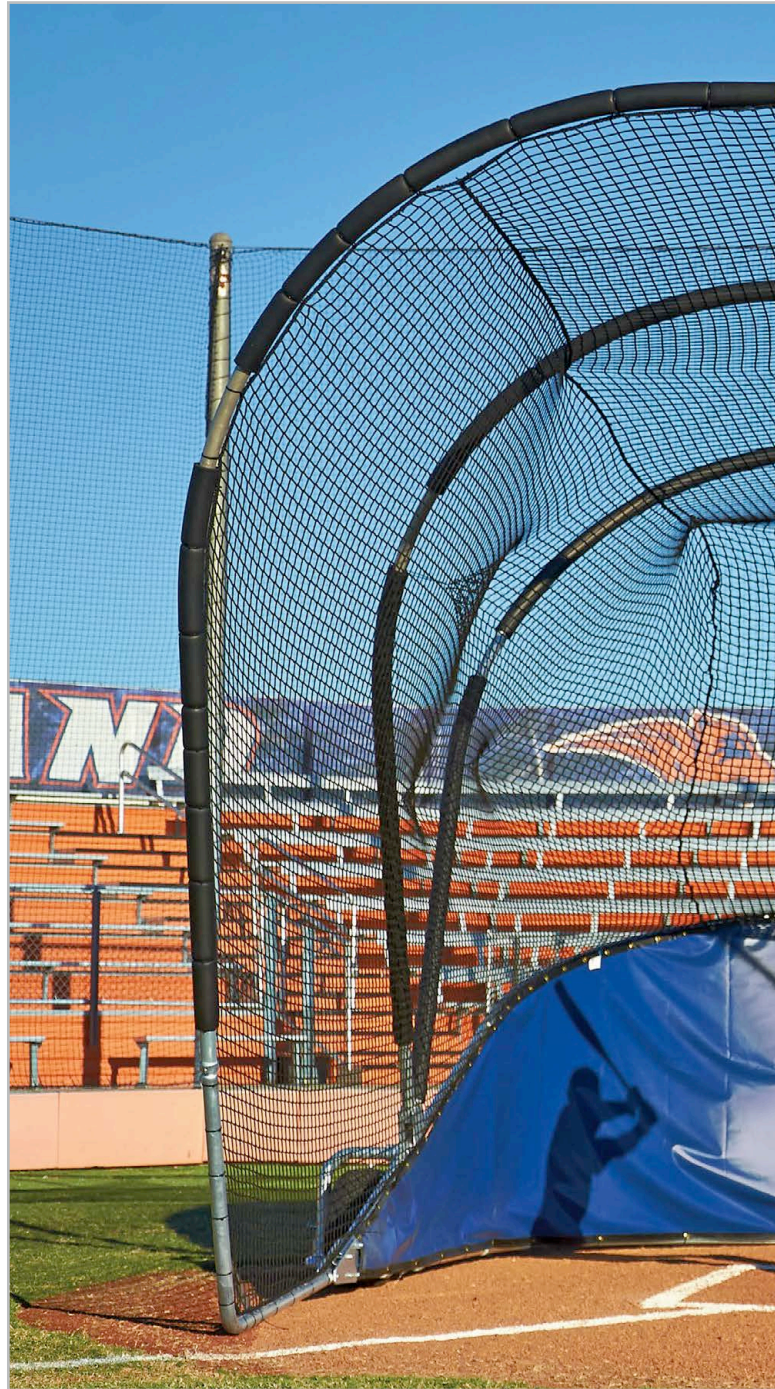



# BUBBA ELITE BATTING CAGE

BASEBALL/SOFTBALL



## BUBBA ELITE BATTING CAGE

- Dual coaches observation platforms, 8.5"W x 18"H pneumatic tires, premium ricochet padding most frame work, 3.5mm weather-treated EHT net w/extra 10' x 10' baffle net, nylon reinforced 18oz. vinyl skirt, black thud pad w/grommets, and lockable dolly lift system portability
- Constructed of 2" heavy-wall aluminum tubing
- Collapses to only 5' high to limit storage
- Interior Dimensions: 18'W x 22'D x 12'H
- Exterior Width: 20'W
- Thud pad: 68"W x 52"H x 4"D
- Shipping Wt 625 lbs.

**\$4,899<sup>99</sup>**

BSELITE ★ Complete Unit

**\$549<sup>99</sup>**

1316681 ★ Replacement Dolley

**\$804<sup>99</sup>**

BSBNT ★ Replacement Net

**\$369<sup>99</sup>**

BSBSK ★ Replacement Skirt

Stock Color Options:

BLACK

GREEN

NAVY

RED

ROYAL

**\$25<sup>99</sup>**

1273830 ★ Ricochet Cushion

**\$299<sup>99</sup>**

1217612 ★ Thud Pad

**COLLAPSIBLE & PORTABLE!****FOLDABLE, PORTABLE BATTING CAGE**

- Constructed of 2" O.D. 14 gauge flo-coated galvanized steel
- Features a lockable dolly lift system, three 16"D x 4"W pneumatic tires for easy mobility, 3.5 mm weather-treated EHT net with extra baffle net, 18' of ricochet cushion
- Optional 18 oz. vinyl skirt available for those who want a solid lower backdrop
- Interior dimensions: 16.5'W x 16.5'D x 11'H
- Weight: 650 lbs.

<b>BS4000F</b>	Complete unit	\$3,499 <sup>92</sup> EA ★
<b>BS4FNET</b>	Replacement Net only	\$894 <sup>92</sup> EA ★
<b>I274059</b>	Replacement Skirt - Black Only	\$279 <sup>92</sup> EA
<b>I273830</b>	Ricochet Cushion - sold in 6' lengths	\$25 <sup>92</sup> EA ★
<b>I274042</b>	Replacement Dolly	\$599 <sup>92</sup> EA ★

**SAFEFOAM PADDING**

- Premium grade padding for fence tops, pipes, rails, around dugouts, etc.
- Pre-slit for easy installation
- Fits completely over any round pipe that is 2-1/8" in diameter
- Secure with 19" tie wraps (sold separately)
- **Minimum order of 6 pieces**
- **5 Year Limited Warranty**
- Color Options: **Black, Blue, Grey, Green, Purple, Red, Yellow.**

I158847	Padding (8' piece)	\$39 <sup>92</sup> EA
I274035	Tie wraps (Black,Blue,Green,Red,Yellow)	\$52 <sup>92</sup> 100/SET

**PORTABLE BATTING CAGE**

- Constructed of 2" O.D. 14 gauge flo-coated galvanized steel.
- Cage features include: lockable dolly lift system, three 16"D x 4"W pneumatic tires for easy mobility, heavy-duty 3.5 mm weather-treated EHT netting with extra baffle net behind batter.
- Extra width to accommodate left or right hand hitters without shifting the cage.
- Dims: 18'W x 12'D x 12.5'H
- Wt 500 lbs.

<b>BS4000</b>	Complete unit	\$2,799 <sup>92</sup> EA ★
<b>BS4NET</b>	Replacement Net only	\$852 <sup>92</sup> EA ★
<b>I273830</b>	Ricochet Cushion - sold in 6' lengths	\$25 <sup>92</sup> EA ★
<b>I274042</b>	Replacement Dolly	\$599 <sup>92</sup> EA ★

**COACH'S VIEWING PLATFORM**

- Coaches can now view batting practice from this portable, adjustable stand.
- Constructed of 1 1/2" round aluminum tubing.
- Each stand is 20" wide and 10.5" from the ground.
- The stand will fold for safety and convenient storage.
- **5 Year Limited Warranty**

<b>BSBCPLT</b>		\$279 <sup>92</sup> EA ★
----------------	--	--------------------------





**BIG BUBBA  
PRO BATTING CAGE**

**\$4,299.99**

BSBUBBA ★ Complete Unit

**BIG BUBBA PRO BATTING CAGE**

- Constructed of 2" heavy-wall aluminum tubing, pneumatic tires, 42' of ricochet cushion, 3.5mm weather treated EHT net w/ extra 10'x10' baffle net, 18oz. vinyl skirt and lockable dolley lift system for easy portability.
- Optional thud pad features 18oz. vinyl cover.
- Interior Dims: 18'W x 22'D x 12'H
- Collapses to 19' W X 13.5' D X 5.5' H
- Exterior width: 19'W
- Shipping weight 408 lbs.
- 5 Year Limited Warranty

Stock Color Options:



Quickly Collapses for Portability & Storage

**ADDITIONAL OPTIONS**

<b>BSBNT</b>	Replacement Net with Baffle	\$804 <sup>22</sup> EA
<b>BSBSK</b>	Repl. vinyl skirt (specify color)	\$369 <sup>22</sup> EA
<b>I150988</b>	4' H x 6'L Thud Pad (specify color)	\$329 <sup>22</sup> EA
<b>I273830</b>	Ricochet Cushion - sold in 6' lengths	\$25 <sup>22</sup> EA ★
<b>I274042</b>	Replacement Dolley	\$599 <sup>22</sup> EA ★

**Add Your School Name, Mascot or Logo**

Fonts Available:  
**ALLSTAR VARSITY**  
Old English

Custom Logo & Additional Lettering Available  
Call for Pricing and Details



**SUPREME SKIRT**

- Made with exclusive Vipol® Matrix Material, a super-durable mesh fabric of tightly woven micro-fibers.
- Virtually tear-proof with 22% wind pass through.
- Fully sun-UV and mildew inhibitor protected.

I300574	Supreme Skirt - Blank - Specify color	\$419 <sup>22</sup> EA
I298154	Supreme Skirt Letters - Up to 24" Tall	\$49 <sup>22</sup> EA

Choose from 20 Supreme Skirt Color Options!



## VARSITY TUNNEL FRAMES

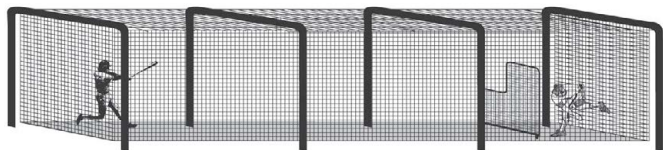

### VARSITY TUNNEL FRAMES

- Constructed of 2" round, 13 gauge galvanized steel powder coated black tubing
- System includes upright poles, cross member, ground sleeves, cable, clamps, eyebolts, turnbuckle and snap rings
- Fits all cages up to 14'W and 12'H
- Frame size after installation is 16"W x 12'H
- Net will hang at 11' - allowing 1' on the ground to contain balls
- **Recommend: Collegiate Series Tunnel Nets - sold separately**
- **3 Section frame for nets 55' and shorter**
- **4 Section frame for nets 70' and longer**

BS10000	3 Section Frame	\$1,454 <sup>92</sup> EA	★	<b>SAH</b>
BS10004	4 Section Frame	\$1,799 <sup>92</sup> EA	★	<b>SAH</b>
I235807	Replacement Hardware Only	\$294 <sup>92</sup> EA	★	

## PRO TUNNEL FRAMES



Shown with Turf Roll (sold separately)



### PRO TUNNEL FRAME

- Super-Duty 3.5" OD 13-gauge galvanized steel pipe
- Available in surface mount, in ground and semi-permanent (with use of optional ground sleeves)
- Includes steel cable, clamp, turn buckles and quick links
- Complete installation instructions and hardware included
- 16'W x 11.5'H

#### 5 Year Limited Warranty

I253634	3 Section Frame - Surface Mount	\$2,199 <sup>92</sup> EA	★	<b>SAH</b>
I274639	4 Section Frame - Surface Mount	\$2,599 <sup>92</sup> EA	★	<b>SAH</b>
I375091	3 Section Frame - In Ground	\$1,999 <sup>92</sup> EA	★	<b>SAH</b>
I375092	4 Section Frame - In Ground	\$2,499 <sup>92</sup> EA	★	<b>SAH</b>
I375093	Ground sleeves (optional)	\$99 <sup>92</sup> PR	★	

**allied**  
TUBE & CONDUIT™  
A PART OF atkore



### BATTING CAGE DOOR

- All steel frame - easy to assemble
- Free standing door
- Lacing rope included
- Door size: 30 1/2"W x 72 1/2"H
- Door frame: 33 3/4"W x 76 1/2"H
- Weight 35 lbs.

I362312



\$199<sup>92</sup> EA

## SUSPENSION KITS

### INDOOR WALL TO WALL SUSPENSION KIT

- Includes everything you need to suspend a batting cage tunnel between two walls inside a gym or training facility (net not included)

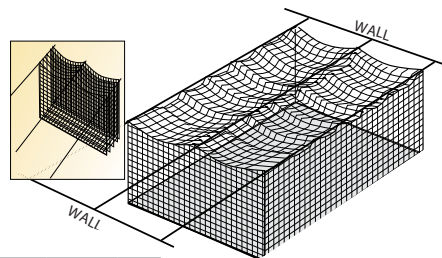

I236637

\$359<sup>92</sup> EA

### CEILING NET SUSPENSION KIT

- Includes everything you need to suspend a batting cage tunnel from the ceiling inside a gym or training facility (net not included)

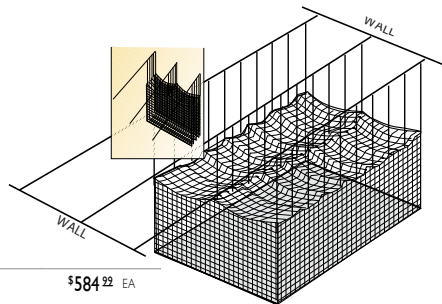

I236644

\$584<sup>92</sup> EA

## COLLAPSIBLE TUNNEL

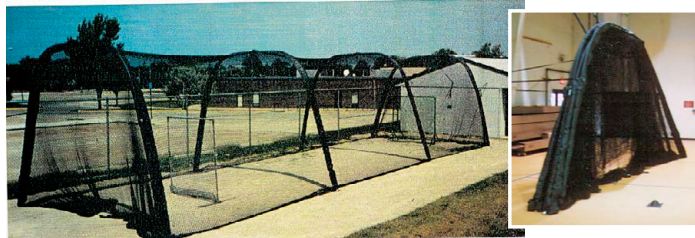

Collapsed

### COLLAPSIBLE BATTING TUNNEL

- Perfect for those that want a standard sized tunnel with limited space
- Choose indoor or outdoor model in 54' or 72' length
- Collapses to 2' for easy storage in less than two minutes
- Net features black 42 thread knotless nylon construction
- Cage arches are galvanized steel
- Cage comes with an instructional video

Select Model: **Indoor, Outdoor, Indoor / Outdoor.**

BBCAGE54	Youth/Softball Size - 54'L x 18'W x 12'H	\$6,099 <sup>92</sup> EA	<b>SAH</b>
BBCAGE72	Baseball Size - 72'L x 18'W x 12'H	\$6,699 <sup>92</sup> EA	<b>SAH</b>

Batco cages are very large - be sure you have enough room in your gym. NO RETURNS ALLOWED.

## TUNNEL NETS



**Gold Medal**  
ATHLETIC PRODUCTS

**QUALITY. DURABILITY. CRAFTSMANSHIP. For over 125 years**

### ALL-STAR SERIES TUNNELS (NYLON)

- 3.5mm #36 thread twisted knotted nylon
- 380 lb. breaking strength
- Nyothene weather treatment for outdoor use
- Durable vinyl border to prevent fraying
- Includes 14' x 12' backing to resist net wear
- Includes three full-length ropes to prevent sagging

<b>I245035</b>	70'L x 14'W x 12'H	\$1,869 <sup>22</sup> EA	★
<b>I245042</b>	70'L x 12'W x 12'H	\$1,799 <sup>22</sup> EA	★
<b>I245059</b>	55'L x 14'W x 12'H	\$1,649 <sup>22</sup> EA	★

### MAJOR LEAGUE SERIES TUNNELS

- 3.0 mm braided knotless EHT netting
- Weather resistant with built in UV protection
- Includes extra baffle to resist wear behind batter
- Includes three full-length ropes to prevent sagging

<b>BS47514</b>	75'L x 14'W x 12'H	\$1,624 <sup>22</sup> EA	★
<b>I187991</b>	70'L x 14'W x 12'H	\$1,564 <sup>22</sup> EA	★
<b>I188004</b>	70'L x 12'W x 12'H	\$1,454 <sup>22</sup> EA	★
<b>BS45514</b>	55'L x 12'W x 12'H	\$1,249 <sup>22</sup> EA	★

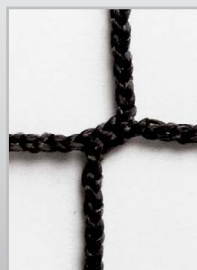

### PRO SERIES TUNNELS

- 2.5mm #42 twisted knotted polyethylene
- 225 lb. breaking strength
- 100% water proof and UV treated
- Extruded permanent black color
- Three ropes running lengthwise on top and all 4 corners for "no sag" net system

<b>BS37014</b>	70'L x 14'W x 12'H	\$1,199 <sup>22</sup> EA	★
<b>BS37012</b>	70'L x 12'W x 12'H	\$1,119 <sup>22</sup> EA	★
<b>BS35544</b>	55'L x 14'W x 14'H	\$934 <sup>22</sup> EA	★
<b>BS35514</b>	55'L x 14'W x 12'H	\$924 <sup>22</sup> EA	★
<b>BS35512</b>	55'L x 12'W x 12'H	\$879 <sup>22</sup> EA	★



### COLLEGIATE SERIES TUNNELS

- 2.0mm #24 twisted knotted polyethylene
- 185 lb. breaking strength
- Same great features as Pro Series tunnels, but for those on a tighter budget

<b>BS27014</b>	70'L x 14'W x 12'H	\$899 <sup>22</sup> EA	★
<b>BS27012</b>	70'L x 12'W x 12'H	\$842 <sup>22</sup> EA	★
<b>BS25544</b>	55'L x 14'W x 14'H	\$829 <sup>22</sup> EA	★
<b>BS25514</b>	55'L x 14'W x 12'H	\$799 <sup>22</sup> EA	★
<b>BS23514</b>	35'L x 14'W x 12'H	\$599 <sup>22</sup> EA	★

### TUNNEL/CAGE SAVERS

- Heavy duty reinforced vinyl tarp to protect the netting in your batting cage
- Includes grommets and corner ropes
- Size - 5'W x 7'H

Color Options: **Dark Green, Royal, Red.**

<b>I236651</b>	22 oz. vinyl w/ White Target	\$182 <sup>22</sup> EA
<b>I269918</b>	30 oz. Black w/ Orange Target	\$187 <sup>22</sup> EA
<b>I269925</b>	30 oz. Navy w/ Yellow Target	\$187 <sup>22</sup> EA



### NET SAVERS

- Prevents costly and dangerous holes created by other tie down methods
- Constructed of impact-resistant 6" plastic disk
- Inner layer of soft protective foam
- Spring clips and rope not included

<b>I149470</b>	\$59 <sup>22</sup> SET OF 4
----------------	-----------------------------



### BATTING TUNNEL NET PROTECTOR PAD

- Protect your tunnel with this vinyl covered backstop pad
- Perfect for any indoor or outdoor batting cage
- Size - 3'W x 4'H x 1-1/2" thick

<b>200180453</b>	\$119 <sup>22</sup> EA
------------------	------------------------



### VINYL BACKDROP WITH TARGET

- Constructed of heavy duty 40oz. vinyl with white strike zone.
- Strike zone is 18"W x 30"H

<b>I323467</b>	Size - 5'W x 6'H	\$144 <sup>22</sup> EA
----------------	------------------	------------------------



## VARSITY



- Heavy-duty 1-1/2" round green powder-coated steel
- Frames are 7' H x 6' W
- #36 weather-treated polyethylene slip-on pillow case style net

## FUNGO PROTECTIVE SCREENS

3. <b>BSVFS10</b>	Complete Unit - 10' x 10'	\$249 <sup>22</sup> EA ★
<b>BSVFS10N</b>	Replacement Net - 10' x 10'	\$84 <sup>22</sup> EA ★
4. <b>BSVFS</b>	Complete Unit - 7' x 6'	\$229 <sup>22</sup> EA ★
<b>BSVFSNET</b>	Replacement Net - 7' x 6'	\$74 <sup>22</sup> EA ★

## SOCK NET WITH FRAME

1. <b>BSVSN</b>	Complete Unit	\$269 <sup>22</sup> EA ★
<b>BSVSNET</b>	Replacement Net	\$84 <sup>22</sup> EA ★

## VARSITY SOFTBALL PROTECTOR SCREEN

2. <b>BSVSP</b>	Complete Unit	\$244 <sup>22</sup> EA ★
<b>BSVSPNET</b>	Replacement Net	\$69 <sup>22</sup> EA ★

## PITCHERS PROTECTIVE SCREEN

5. <b>BSVLS</b>	Complete Unit	\$244 <sup>22</sup> EA ★
<b>BSVLSNET</b>	Replacement Net	\$84 <sup>22</sup> EA ★



## TRI FOLD SCREEN

- Great for batting cages and bullpens
- Can be used as a temporary backstop for outfield batting practice / fungo
- Folds flat for easy transportation and storage
- 8' middle section with 4' foldable wings on both sides



<b>1296730</b>	Complete Unit with Wheels	\$334 <sup>22</sup> EA ★ <b>SetH</b>
<b>1291544</b>	Replacement Net	\$79 <sup>22</sup> SET ★



## VARSITY FOLDING L SCREEN

- 7' x 7'
- Breaks down in seconds
- Includes wheels for easy transportation

<b>1301038</b>		\$279 <sup>22</sup> EA ★ <b>SetH</b>
----------------	--	--------------------------------------

## WHEEL KIT

- For use on all collegiate and varsity protective screens
- 6" poly wheels with steel brackets

<b>BSWKIT</b>	\$84 <sup>22</sup> EA ★
---------------	-------------------------



## Collegiate

## Varsity

## NET REPAIR/LACING CORDS

Black poly twine. 100' spool, 3 mm.

<b>1236743</b>	100' Spool - 3mm	\$13 <sup>22</sup> SPOOL ★
<b>MTTWINEB</b>	500' Spool - 3 mm	\$39 <sup>22</sup> SPOOL H



## PROFESSIONAL



- Oversized for maximum protection
- Slip-over pillow case (3.0 mm) nylon net included
- Heavy wall construction
- 10" no flat tires for easy transporting

### BASE/FUNGO SCREENS

1. <b>BSFPRO10</b> <b>BSFPRO10N</b>	Complete Unit - 10' x 10' Replacement Net - 10'H x 10'W	\$859 <sup>22</sup> EA ★ <b>S&amp;H</b> \$239 <sup>22</sup> EA ★
2. <b>BSFPRO8</b> <b>BSFPRO8N</b>	Complete Unit - 8' x 8' Replacement Net - 8'H x 8'W	\$784 <sup>22</sup> EA ★ <b>S&amp;H</b> \$209 <sup>22</sup> EA ★

### TRI-FOLD FUNGO SCREEN

3. <b>BSFPRO16</b> <b>BSFPRO8N</b> <b>I265279</b>	Complete Unit - 8'H x 16'W Replacement Net - Middle Section Replacement Net - Side Wings (pair)	\$1,019 <sup>22</sup> EA ★ <b>S&amp;H</b> \$209 <sup>22</sup> EA ★ \$229 <sup>22</sup> PR ★
---	---	---

### PRO L-SCREEN

4. <b>BSPROL</b> <b>BSPROLS</b> <b>BSLPRON</b>	Complete Unit - 8' x 8' - Aluminum Complete Unit - 8' x 8' - Steel Replacement Net - 8' x 8'	\$764 <sup>22</sup> EA ★ <b>S&amp;H</b> \$764 <sup>22</sup> EA ★ <b>S&amp;H</b> \$239 <sup>22</sup> EA ★
--	--	--

### 5. MINI L SCREEN

<b>BSFPRO5</b> <b>I296464</b>	Complete Unit - 7'H x 5'W Replacement Net	\$559 <sup>22</sup> EA ★ <b>S&amp;H</b> \$149 <sup>22</sup> EA ★
----------------------------------	--	---

## COLLEGIATE



- Heavy-duty 1 1/2" square 17 gauge galvanized steel
- Frames are 7' H x 7' W
- 2.5mm twisted knotted polyethylene slip-on pillow case style net

### 1. FIRST BASE / FUNGO PROTECTOR

<b>BS47710</b> <b>BS47710NET</b>	Complete Unit Replacement Net	\$264 <sup>22</sup> EA ★ <b>S&amp;H</b> \$104 <sup>22</sup> EA ★
-------------------------------------	----------------------------------	---

### 2. PITCHERS PROTECTOR

<b>BS47743</b> <b>BS47743NET</b>	Complete Unit Replacement Net	\$269 <sup>22</sup> EA ★ <b>S&amp;H</b> \$129 <sup>22</sup> EA ★
-------------------------------------	----------------------------------	---

### 3. SOCK NET AND FRAME

<b>BS47700</b> <b>BS47700NET</b>	Complete Unit Replacement Net	\$332 <sup>22</sup> EA ★ <b>S&amp;H</b> \$154 <sup>22</sup> EA ★
-------------------------------------	----------------------------------	---

### 4. C-SHAPED SOFTBALL PITCHERS PROTECTOR

<b>I366836</b> <b>I366836N</b>	Complete Unit Replacement Net	\$259 <sup>22</sup> EA ★ <b>S&amp;H</b> \$124 <sup>22</sup> EA ★
-----------------------------------	----------------------------------	---

### 5. SOFTBALL PITCHER PROTECTOR

<b>BS47750</b> <b>BS47750NET</b>	Complete Unit Replacement Net	\$279 <sup>22</sup> EA ★ <b>S&amp;H</b> \$129 <sup>22</sup> EA ★
-------------------------------------	----------------------------------	---

10' w/Hood & Wings (BSCL10HW)



### CHAIN LINK BACKSTOPS

- Permanent backstops are erected by installing supplied 2-3/8" pipe supports approximately every 10' in concrete footings
- Then, simply bolt prefabricated 5' x 10' panels in place to create your finished backstop
- 5' x 10' panels are composed of 1-5/16" OD galvanized tubing with center reinforcing brace and 9 gauge galvanized woven wire
- Backstops are extremely durable and allow individual panels to be removed or replacement as needed

**5 Year Limited Warranty**

<b>BSCL10</b>	10' - No Hood or Wings	\$2,029 <sup>22</sup> SET ★ <b>S&amp;H</b>
<b>BSCL10H</b>	10' w/Hood-No Wings	\$2,499 <sup>22</sup> SET ★ <b>S&amp;H</b>
<b>BSCL10HW</b>	10' w/Hood & Wings	\$2,949 <sup>22</sup> SET ★ <b>S&amp;H</b>
<b>BSCL20</b>	20' - No Hood or Wings	\$2,754 <sup>22</sup> SET ★ <b>S&amp;H</b>
<b>BSCL20H</b>	20' w/Hood-No Wings	\$3,399 <sup>22</sup> SET ★ <b>S&amp;H</b>
<b>BSCL20HW</b>	20' w/Hood & Wings	\$4,109 <sup>22</sup> SET ★ <b>S&amp;H</b>

### AVAILABLE STYLES

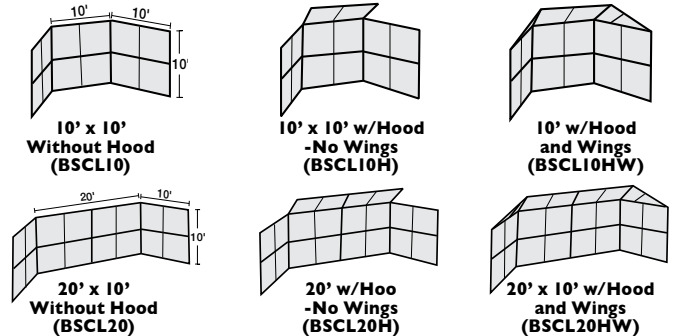

A PART OF **atkore**

### HITTING STATION

- Perfect for hitting practice
- 2 3/8" diameter galvanized steel construction
- Installed dimensions - 10'H x 11'W x 1'D
- Can be installed permanently or semi permanent with ground sleeves
- Turf mat and concrete not included

**3 Year Limited Warranty**



**BHHTSTA**

Complete Unit

\$669<sup>22</sup> EA ★ **S&H**

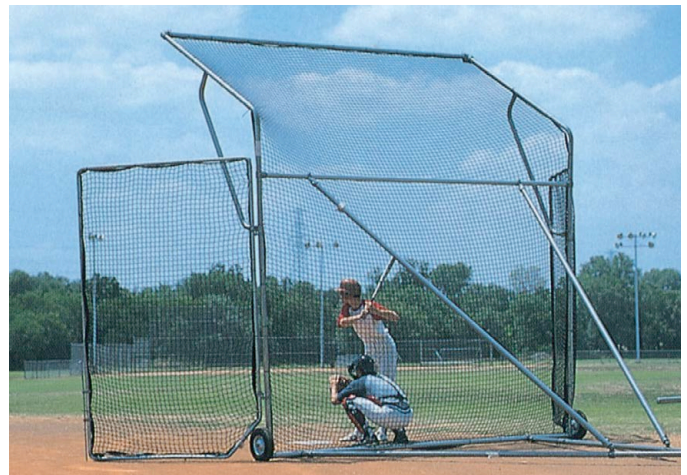

### SANDLOT PORTABLE BACKSTOP

- Constructed of heavy duty 2" OD 14 gauge flo-coated galvanized steel
- 9'H x 6'W sidewings and extend to provide up to 28' of backstop
- Semi-pneumatic tires and ground stakes for anchoring
- Heavy duty weather treated nets included
- Weight: 400 lbs.

**BBBSWING**  
**SNWINGCTDS**  
**SNWINGS**

Complete Unit	\$2,339 <sup>22</sup> EA ★ <b>S&amp;H</b>
Replacement Net for Back and Top	\$269 <sup>22</sup> EA ★
Replacement Net for Wings (requires 2)	\$139 <sup>22</sup> EA ★



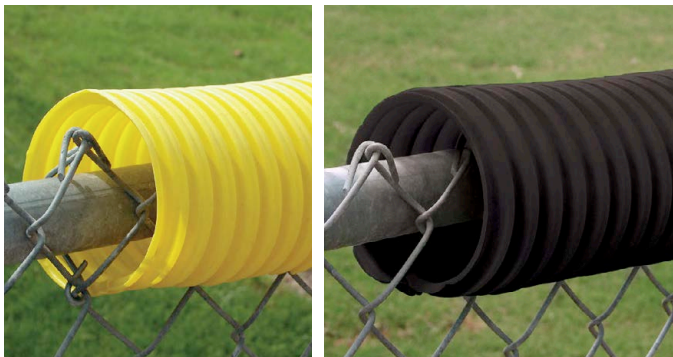

### FENCE CROWN PROTECTIVE FENCE GUARD

- An economical way to increase safety
- Reduce player injuries and increasing visibility
- Weather treated and UV protected
- Slit and ready for easy installation with matching tie wraps every 3'
- Tie wraps NOT included
- **Actual freight charges apply**



I196726	Bright Yellow - 100'	\$167 <sup>22</sup>	ROLL	
I196733	Bright Yellow - 250'	\$219 <sup>22</sup>	ROLL	
I269949	Black - 100'	\$167 <sup>22</sup>	ROLL	
I269932	Black - 250'	\$219 <sup>22</sup>	ROLL	
I196764	Yellow - 19" tie wraps - 100 per pack	\$52 <sup>22</sup>	PACK	
I269956	Black - 19" tie wraps 100 per pack	\$52 <sup>22</sup>	PACK	



### DELUX FENCE TOP RAIL PADDING

- Provides superior appearance and protection on the top of chain link and outfield fences.
- 2" thick foam is encased in 18 oz. vinyl w/ grommets for attachment.
- Fits up to 2 1/2" pipe



I273847 6' section \$89<sup>22</sup> EA



### POLY-CAP FENCE GUARD

- Installed over your chain link fence adds safety and reduces player injuries
- Increases visibility
- Beautifies any field
- Weather treated and UV protected
- 4-1/2" in diameter
- **Actual freight charges apply**



BBPC100X	Yellow 100'	\$167 <sup>22</sup>	ROLL	
BBPC250X	Yellow 250'	\$219 <sup>22</sup>	ROLL	
I024005	Green 100'	\$167 <sup>22</sup>	EA	
I024012	Green 250'	\$219 <sup>22</sup>	EA	
<b>BBPCTIES</b>	Yellow 18" tie wraps	\$52 <sup>22</sup>	PACK OF 100	
I048988	Green 18" tie wraps	\$52 <sup>22</sup>	PACK OF 100	
5POLYINST	Poly Cap Installation Tool	\$69 <sup>22</sup>	EA	



### SAFETY TOP CAP

- Resistant to UV and other harmful climate conditions
- To install, simply snap over the top of the fence and fasten cap with steel hog rings (included) through the pre-drilled holes
- Bag contains five 8' pieces (40' per bag)

I273854 Yellow Only \$79<sup>22</sup> BAG



### SAF-TOP FENCE GUARD

- Protect against injuries, increase visibility add beauty to your field
- UV-resistant polyethylene construction is maintenance free
- Sold in boxes of 10 - each 8'L x 3"W x 4"H (80 linear feet per box)
- Pre-drilled and includes ties for quick & easy installation
- 5-year limited warranty



Color Options: **Dark Green, Yellow, Blue, Red.**

I234893 \$169<sup>22</sup> SET OF 10



**TUFFY® WINDSCREEN**

- The toughest, highest quality windscreen in the world
- Made with exclusive Vipol® Matrix 10 oz. material, a super-durable mesh fabric of tightly woven micro fibers
- Offers more sun UV resistance, is virtually tear proof, and has the highest puncture and tear resistance
- Allows 22% wind pass-through - 78% shade factor
- Tuffy is the only windscreen featuring LOCK-STITCH finishing to assure that it's sides and corners do not unravel
- Fully sun UV and mildew inhibitor protected
- Grommets every 12" on all 4 sides
- 9' model complete with half moon vents and a grommet strip line

1323566	5' High	\$0.86	SQ.FT
1285598	6' High	\$0.88	SQ.FT
1285604	9' High	\$0.92	SQ.FT
1298253	Boxed Air Vent	\$9.42	EA



**CHROMA-BOND® IMPRINTING**

- Double coated multicolor imprinting that does not fade, flake or scuff like other spray on or digital imprinting
- Images are sharp, vivid and outlast any other type of imprinting
- School colors can be matched

**2 Color Logo & Lettering on a 3rd Color Background**

1297782	Overall Size up to 4'H x 50'L	\$1,749.22	EA
1297799	Overall Size up to 3'H x 30'L	\$1,499.22	EA

**1, 2 or 3 Color Print**

1380610	1 Color up to 25 sq. ft.	\$499.22	EA
1380611	1 Color 26-50 sq. ft.	\$649.22	EA
1380612	1 Color 51-100 sq. ft.	\$949.22	EA
1380613	2 Color up to 25 sq. ft.	\$599.22	EA
1380614	2 Color 26-50 sq. ft.	\$749.22	EA
1380615	2 Color 51-100 sq. ft.	\$999.22	EA
1380616	3 Color up to 25 sq. ft.	\$699.22	EA
1380617	3 Color 26-51 sq. ft.	\$849.22	EA
1380618	3 Color 51-100 sq. ft.	\$1,099.22	EA

**1 or 2 Color Letters only**

1298154	Up to 24" T	\$49.22	EA
1298161	Up to 36" Tall	\$59.22	EA
1298178	Up to 48" Tall	\$74.22	EA
1298185	Up to 60" Tall	\$86.22	EA
1298192	Up to 72" Tall	\$104.22	EA
1298208	Up to 84" Tall	\$119.22	EA

**Fonts Available**

**ALLSTAR VARSITY Old English**

Specify colors for all imprints. Call for more font options



**OUTFIELD DISTANCE MARKERS**

- Numbers and logos in Chroma-Bond® imprinting on Vipol Matrix Mesh means these will stay vivid much longer than normal distance markers.
- Please specify color(s) and distances.
- Marker fabric colors are the same as Tuffy windscreens colors shown above.

**4 Year Limited Warranty**

1. 1298215	Numbers only, 5'L - Vertical or Horizontal	\$149.22	EA
2. 1298222	White Baseball - 3'D	\$194.22	EA
3. 1298239	Yellow Softball - 3'D	\$194.22	EA
4. 1298246	2 Color Logo w/ Vertical Numbers - 5'H	\$279.22	EA





QUALITY • DURABILITY • CRAFTSMANSHIP For over 125 years



BASEBALL/SOFTBALL

### POLYESTER WINDSCREEN

- Features: 8oz. polyester construction, 70% shade factor, maximum UV protection and a 6-ply 2" vinyl mesh reinforced border
- Brass grommets on all four sides at 12" intervals
- 9' (item 1079636) comes complete with center tie down strip and half moon vents
- Upgrade to boxed air vents at an additional charge

#### 2 Year Limited Warranty

1158762	up tp 5'H	\$0.72	SQ.FT
1079608	6'H	\$0.73	SQ.FT
1079636	9'H	\$0.75	SQ.FT
1298253	Boxed Air Vent	\$9.42	EA

#### Windscreen Hardware and Accessories

<b>MTTWRAPS</b>	7" tie wraps (50 lbs. breaking strength)	\$16.42	PACK OF 100
MTCTDOWN	Center Tie Down	\$0.49	FT
MTTCTDXX	1/4" Black Braided Nylon-200' roll	\$27.22	ROLL
<b>MTSHOOKS</b>	2 1/2" Plated Steel S-Hooks	\$19.22	PACK OF 100
1298253	Boxed Air Vent	\$9.42	EA

Choose from 6 color options.



### POLYPLUS WINDSCREEN (OPEN MESH)

- Perfect for high wind areas - allowing 25% wind pass through
- Constructed of open mesh Leno Polypropylene with special reinforcing threads to resist tearing
- Grommets on all 4 sides at 12" intervals
- 100% mildew proof
- 9' style includes center tie down but not air vents

MT6LPXXX	6'H - Dark Green	\$0.76	SQ.FT
MT6LPBLX	6'H - Royal Blue	\$0.76	SQ.FT
MT6LPBXX	6'H - Black	\$0.76	SQ.FT
MT9LPCXX	9'H - Dark Green or Black	\$0.82	SQ.FT



### POLYPROPYLENE WINDSCREEN (CLOSED MESH)

- Mildew and insect resistant and contains a built in UV inhibitor to withstand exposure to sun, wind and rain.
- 95% shade factor
- Includes grommets on all 4 sides spaced every 12"
- Center tie downs are included but not air vents (recommended)

MT6PPCMX	6' High - Dark Green only	\$0.83	SQ.FT
MT9PPCMX	9' High - Dark Green only	\$0.88	SQ.FT
MTCTDOWN	Center Tie Down	\$0.49	FT
1298253	Boxed Air Vent	\$9.42	EA

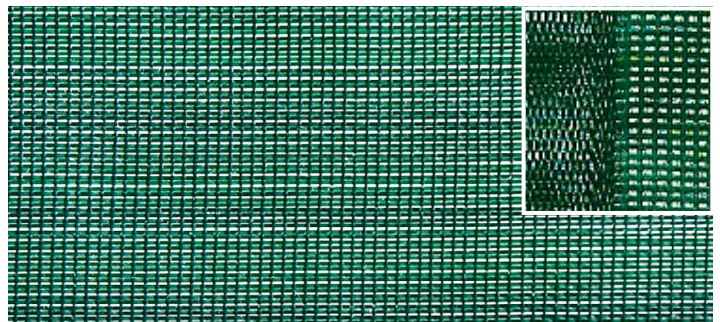

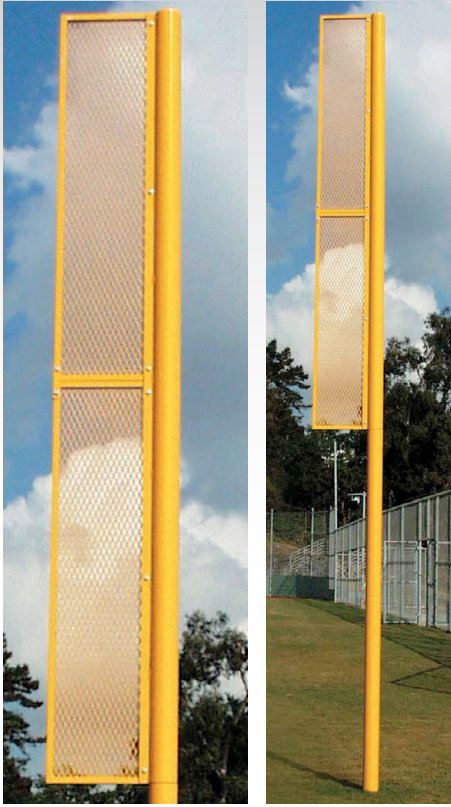

### PROFESSIONAL FOUL POLES (3 1/2" OD POLES)

- Constructed of 3.5" OD 13 gauge heavy duty steel
- Powder coated optic yellow
- Easy to see day or night
- Professional 18"W expanded metal wing
- Sold in pairs

<b>BSFOUL</b>	20' Above Ground, 12' Wing, Weight: 362 lbs/pr.	\$1,379 <sup>22</sup> PR ★
<b>BSFOUL15</b>	15' Above Ground, 8' Wing, Weight: 272 lbs/pr.	\$1,199 <sup>22</sup> PR ★
<b>BSFOUL12</b>	12' Above Ground, 6' Wing, Weight: 220 lbs/pr.	\$999 <sup>22</sup> PR ★

### GROUND SLEEVES FOR 3 1/2" OD FOUL POLES

<b>1255294</b>	48" Ground Sleeves for BSFOUL	\$314 <sup>22</sup> PR ★
<b>1255287</b>	36" Ground Sleeves for BSFOUL15 or BSFOUL12	\$299 <sup>22</sup> PR ★



### STANDARD FOLDING BACKSTOP PADDING

- 18 oz. vinyl covers with 2" polyfoam
- Pads are made to fold in 2'W panels for storage and shipping
- Grommets along top, bottom and sides for anchoring

1150919	3'H x 6'L - Weight: 12 lbs.	\$327 <sup>22</sup> EA
1150926	3'H x 8'L - Weight: 16 lbs	\$369 <sup>22</sup> EA
1150933	3'H x 10'L - Weight: 20 lbs	\$409 <sup>22</sup> EA
1150940	3'H x 12'L - Weight: 24 lbs.	\$472 <sup>22</sup> EA
1150988	4'H x 6'L - Weight: 16 lbs	\$329 <sup>22</sup> EA
1150957	4'H x 8'L - Weight: 20 lbs	\$394 <sup>22</sup> EA
1150964	4'H x 10'L - Weight: 25 lbs	\$469 <sup>22</sup> EA
1150971	4'H x 12'L - Weight: 30 lbs	\$537 <sup>22</sup> EA

### BACKSTOP PADDING

- Designed for use with chain-link or cement
- Features heavy-duty 18 oz. vinyl construction
- 4" open-cell foam padding for true ball rebound
- Grommets are exposed on top for easy attachment to fence, brick or cement

1079720

\$19<sup>22</sup> SQ.FT

## CUSTOM NETTING

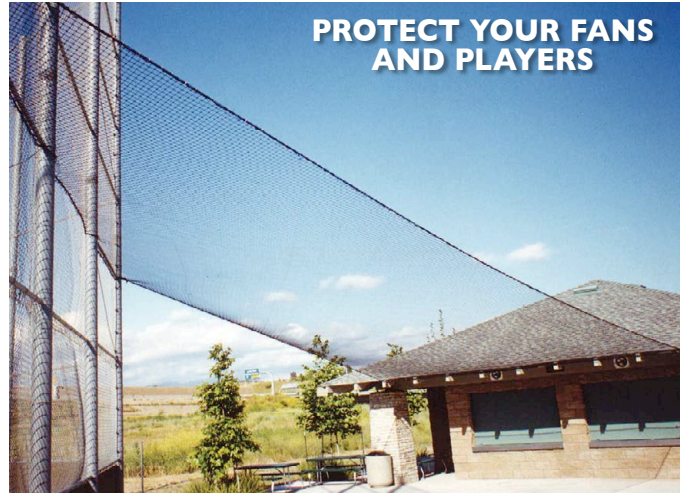

**PROTECT YOUR FANS AND PLAYERS**







Rope Border



Vinyl Border w/Grommets

**BASEBALL/SOFTBALL**

- Available in four grades of size and strength to fit your budget and program needs.
- All netting is 1-3/4" mesh, all-weather treated and bordered for a neat, modular look.
- Available with either a rope border or a vinyl border with grommets. Please specify.

WHICH CUSTOM NET DO YOU NEED?				
TWINE SIZE	ALL-STAR	MVP	MAJOR LEAGUE	VARSITY
CONSTRUCTION	#36 Nylon Twisted-Knotted	3.5 mm Enduro Hybrid Thread Braided-Knotless	3.0 mm Enduro Hybrid Thread Braided-Knotless	2.4 mm Enduro Hybrid Thread Braided-Knotless
BREAK STRENGTH (approximate)	380 lbs.	320 lbs.	275 lbs.	195 lbs.
TREATMENT	Additional UV treatment and black color	Extruded thread with built in UV treatment, weather protection and Black color. Weather Proof, Mold and Mildew Resistant	Extruded thread with built in UV treatment, weather protection and Black color. Weather Proof, Mold and Mildew Resistant	Extruded thread with built in UV treatment, weather protection and Black color. Weather Proof, Mold and Mildew Resistant
WT / SQ FT	.040	.050	.036	.023
CODE	I238525	I188059	I188042	I188066
PRICE	\$0.99 SQ.FT	\$0.88 SQ.FT	\$0.79 SQ.FT	\$0.74 SQ.FT

## BOUNDRY NETTING



#420

### PRE-CUT BOUNDRY/PROTECTIVE NETTING

- 1-3/4" mesh, weather treated Varsity (#420) EHT black knotless netting
- Netting is UV resistant
- Heavy overlack stitched rope border
- All panels are rectangular in shape

<b>I236576</b>	Net Size 10' x 30'	\$167 <sup>99</sup> EA ★
<b>I236583</b>	Net Size 12' x 50'	\$299 <sup>99</sup> EA ★
<b>I236590</b>	Net Size 14' x 50'	\$387 <sup>99</sup> EA ★
<b>I236606</b>	Net Size 14' x 100'	\$787 <sup>99</sup> EA ★



### BAFFLE/DIVIDER NET WITH ROPE BORDER

- 2.5mm #42 thread twisted knotted polyethylene
- Net can be hung inside your batting cage to divide it or act as a double back

<b>I236705</b>	Net Size - 12' x 14'	\$129 <sup>99</sup> EA ★
----------------	----------------------	--------------------------



### PORTABLE OUTFIELD FENCING

Durable polyethylene square mesh fencing, ideal for use as a stand alone outfield fence when combined with the Smartpole staking system. Rolls are 48"H x 150'L. Sold as packages that include fence rolls, poles and socket. Specify fence color: **Blue, Dark Green, Scarlet**

### COMPLETE OUTFIELD PACKAGE

Includes:

- 150' of fencing (specify color)
- 16 - 60" smartpoles (2 anchor poles + 14 flexible poles)
- 16 - 12" ground sockets with caps
- Punch-pilot hole tool
- Socket setter and installation sheet

Color Options: **Blue, Dark Green, Scarlet.**

**MKGMFGS**

Specify Color

\$469<sup>22</sup> SET

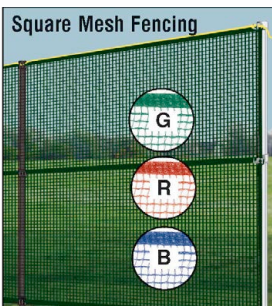
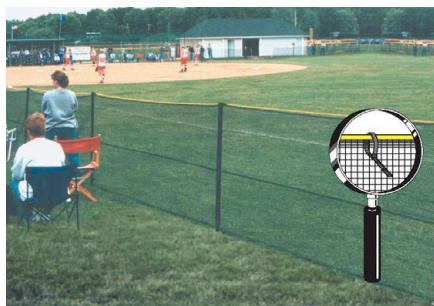

### OUTFIELD PACKAGE WITHOUT GROUND SOCKETS

Includes:

- 150' of Fencing (specify color)
- 16 - 60" SmartPoles (2 anchor poles + 14 flexible poles)
- Punch-pilot hole tool
- Socket setter and installation sheet

Color Options: **Blue, Dark Green, Scarlet.**

**MKGMFSS**

\$399<sup>22</sup> SET



### SMART POLES WITH GROUND SOCKET KIT

- 16 - 60" SmartPoles (14 flex + 2 anchor)
- 16 - 12" ground sockets
- Punch pilot hole tool
- Socket setter
- 160' yellow poly rope
- 50 tie wraps for added stability

**MKI6SP60**

\$329<sup>22</sup> SET

### SMART POLE ONLY KIT

- 16 - 60" SmartPoles (14 flex + 2 anchor)
- Pilot hole
- 160' yellow poly rope
- 50 tie wraps for added stability

**MKI6SSCP**

\$259<sup>22</sup> SET

### SMARTPOLE FLEXIBLE POLE

- Replacement flexible SmartPole

**MKFS60**

Black

\$19<sup>22</sup> EA

### SMARTPOLE REINFORCED ANCHOR POLE

- Replacement anchor pole

**MKRS60**

White

\$19<sup>22</sup> EA



### 16 GROUND SOCKET KIT

- 16 ground sockets with yellow plugs
- Socket setter
- Pilot hole tool

**MKI6GSI2CP**

\$107<sup>22</sup> SET

### GROUND SOCKET WITH CAP

- Permanently install ground sockets for quick and easy fence installation and tear down

**MKGS12**

\$9<sup>22</sup> EA

### FENCING ONLY

- 48"H x 150'L fence only
- Color Options: **Blue, Dark Green, Scarlet.**

**1196788**

specify color \$199<sup>22</sup> ROLL ★

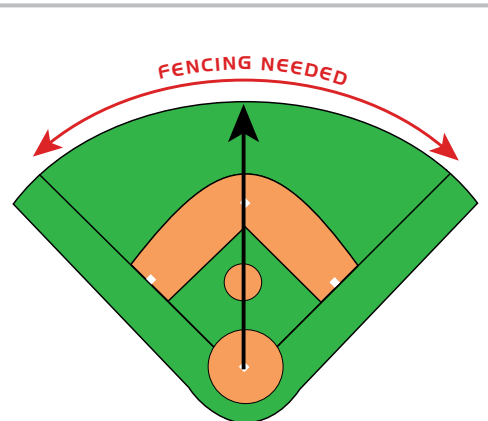
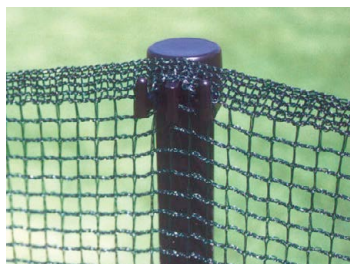

### How much outfield fence do you need?

Home plate to center field

Fencing needed

180'	282.6'
200'	314'
225'	353.25'
250'	392.5'
275'	431.75'
300'	471'
325'	510.25'
350'	549.5'
400'	628'

## ENDURO FENCING WITH YELLOW TOP TAPE

### Sets a new standard for Simplicity, Durability and Appearance.

Simply slide the poles through the permanent vinyl pockets in the mesh fencing and drive the pole into the turf with a rubber mallet. No ropes, ties, clips, hooks, etc. The vinyl pockets, spaced every 10', create an attachment to the pole that is uniform top to bottom. Steel pilot hole tool is included for hard ground. Optional ground sockets available.

Color Options: **Dark Green, Red, Royal.**

## ENDURO FENCING OUTFIELD PACKAGES

Packages include:

- Enduro fence w/pole pockets
- Two (2) white Enduro anchor poles (MKREPI)
- Heavy-duty Enduro flex poles (MKWEPI)
- Steel pilot hole tool

Color Options: **Blue, Dark Green, Red.**

<b>BSF50</b>	50'L Fence with 6 Poles	\$299 <sup>22</sup> SET
<b>BSF150</b>	150'L Fence with 16 Poles	\$639 <sup>22</sup> SET

## 200' HOMERUN FENCE PACKAGE

Package includes:

- 314' of Enduro fence
- 32 Enduro poles
- Pilot-hole tool
- Measuring tape
- Optional ground sockets not included (see below)
- Dark Green only

<b>BS314GP</b>	Complete Package	\$1,499 <sup>22</sup> EA	<b>SAH</b>
<b>BS31516</b>	32 Optional Ground Sockets and Caps	\$200 <sup>00</sup> EA	

## 300' HOMERUN FENCE PACKAGE

Package includes:

- 471' of Enduro fence
- 48 Enduro poles
- Pilot-hole tool
- Measuring tape
- Optional ground sockets not included (see below)
- Dark Green only

<b>BS13515</b>	Complete Package	\$2,099 <sup>22</sup> PACK	<b>SAH</b>
<b>BS13518</b>	48 Optional Ground Sockets and Caps	\$299 <sup>22</sup> KIT	

## ENDURO FENCE ONLY

- Replacement fence only
- Please specify color

Color Options: **Dark Green, Red, Royal.**

<b>I236897</b>	50' - Roll only	\$199 <sup>22</sup> EA	★
<b>I236927</b>	150' - Roll only	\$499 <sup>22</sup> EA	★

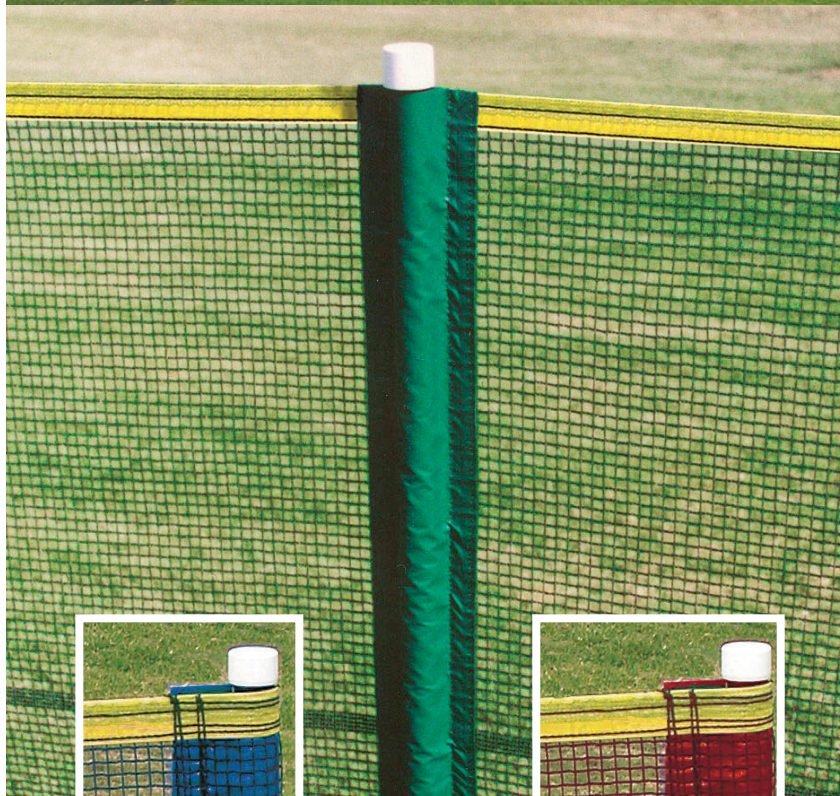
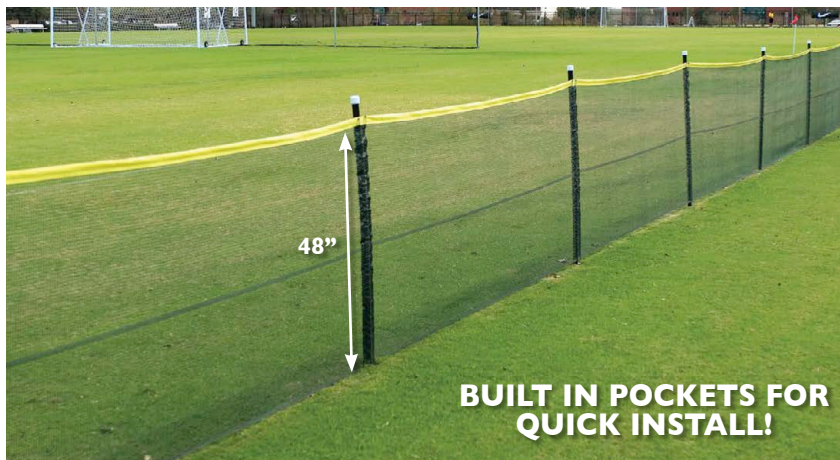

## Accessories

Additional Enduro Poles available for extra stability or replacement.



### ENDURO FLEXIBLE POLES

- Replacement flex poles

<b>MKWEPI</b>	Color: Black only	\$18 <sup>22</sup> EA
<b>MKWEPI6</b>	Set of 16 (14 Flex + 2 Anchor Poles)	\$249 <sup>22</sup> SET

### ENDURO ANCHOR POLE

- Reinforced with metal rod to anchor the Enduro fence system

<b>MKREPI</b>	Color: White only	\$19 <sup>22</sup> EA
---------------	-------------------	-----------------------

### GROUND SOCKET WITH CAP

- Permanently install ground sockets for quick and easy fence installation and tear down

<b>MKGS12</b>	\$9 <sup>22</sup> EA
---------------	----------------------

### GROUND SOCKET CAPS

- 12 pack of plugs for MarkSmart ground sockets
  - Use color coded cap for multiple field configurations
- Color Options: **Orange, White, Yellow.**

<b>MKA103Y</b>	Specify Color	\$13 <sup>22</sup> DZN
----------------	---------------	------------------------

### GROUND SOCKET SETTERS - ONE PAIR

- Designed to be placed in the ground socket so you can hit these instead of the ground socket directly

<b>MKA106</b>	\$3 <sup>22</sup> PR
---------------	----------------------

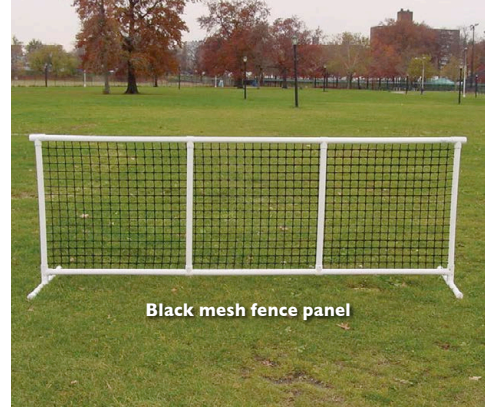

**SPORTPANEL® FENCING**

**FEATURES TECHNO-TIP TECHNOLOGY FOR FLEXIBILITY and SAFETY**

- Designed for portability, panels are lightweight, durable & weather resistant
- Panels are interchangeable and the system expands to meet nearly any size requirement
- Each panel includes two anchor wickets
- Actual freight charges apply
- Panels measure 44”H x 10.5’L

1378436	White Fence Panel	\$199 <sup>zz</sup> EA	
1273861	White Panel with Yellow Safety Top	\$199 <sup>zz</sup> EA	
1037098	Black Mesh Fence Panel	\$209 <sup>zz</sup> EA	
1037128	Foul Poles - 10’H x 15”W	\$209 <sup>zz</sup> EA	
1037104	Extra Leg Anchoring Wickets	\$47 <sup>zz</sup> DZN	
1037111	Extra Foam Panel Connectors	\$52 <sup>zz</sup> DZN	



**PORTABLE CHAIN LINK FENCE PANELS**

- Heavy duty portable chain link fence panels 4’H x 10’L can be used for home run, sideline, crowd control fencing, etc.
- Constructed of galvanized steel frame with 11 gauge chain link fabric
- Legs pivot for storage
- Supplied with connectors to secure panels together
- Weight: 62 lbs. per panel
- **Actual freight charges apply**
- **Minimum purchase of 5 panels**

1149432 \$209<sup>zz</sup> EA ★

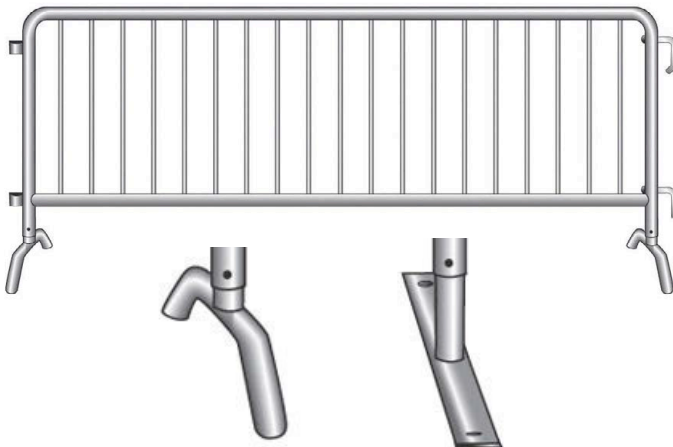

**CROWD CONTROL STEEL BARRICADES**

- Maintenance free crowd control panels are 43”H x 8’L
- Barricade framework is constructed of 16 gauge hot dip galvanized steel
- Choose bridge foot design for maximum stability or flat foot design when funneling crowds into parallel lines to minimize tripping hazards
- Weight: 54 lbs. per barricade
- Actual freight charges apply

1273878	Bridge Foot Design	\$149 <sup>zz</sup> EA	
1273885	Flat Foot Design	\$149 <sup>zz</sup> EA	







### FULL FIELD TARP/COVER

- Constructed of 6 oz woven, 12ml thick polyethylene
- Double-stitched on all four sides with brass grommets placed evenly around the perimeter every 10-12 feet
- Reinforced corners
- Web handles evenly spaced around perimeter every 15' - 20'
- Includes 50 polypro sand bags (sand not included)

#### 3 Year Limited Warranty

1150094	Baseball Cover 170' X 170', Weight: 1200 lbs	\$5,549 <sup>22</sup> EA	
1150100	Baseball Cover 160' x 160', Weight: 1090 lbs	\$5,349 <sup>22</sup> EA	
1150117	Softball Cover 120' x 120', Weight: 615 lbs	\$3,599 <sup>22</sup> EA	
1236774	Youth League Cover 90' x 90', Weight: 400 lbs	\$2,299 <sup>22</sup> EA	

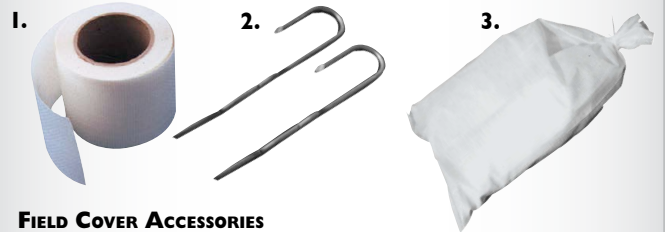

### FIELD COVER ACCESSORIES

1. 1150162	Fieldsaver Repair Tape, 3" x 60' Roll	\$54 <sup>22</sup> EA
2. 1150148	9" Anchor Stakes	\$34 <sup>22</sup> DZN
3. 1150155	Polypropylene Sand Bags (26" x 14") - 20 per set (Sand not Incl.)	\$44 <sup>22</sup> SET OF 20 ★



Black	Dark Green	Grey	Brown	Navy	Burgundy
Purple	Tan	Yellow	Red	Royal	White

### FIELD TARP STORAGE ROLLER COVER

- Heavy duty 22oz vinyl
- Optional lettering available

1274066	3'T x 3'W x 20'L - used with 90' & 120' Tarps	\$279 <sup>22</sup> EA
1274073	3'T x 3'W x 34'L - used with 160' tarps	\$369 <sup>22</sup> EA
1274714	3'T x 3'W x 40'L - used with 170' tarps	\$459 <sup>22</sup> EA
1298154	Lettering up to 24" Tall	\$49 <sup>22</sup> EA



\*The 40' and 34' two-piece roller connects with provided hardware and require connects holes to be drilled after delivery.

### FIELD TARP STORAGE ROLLERS

- Heavy duty corrugated HDPE for tarp storage
- 2-piece rollers provide substantial savings on shipping cost
- Rollers are 28" in diameter

1158939	For 120' and 90' Tarps	\$899 <sup>22</sup> EA	
1158953	For 160' Tarps	\$1,649 <sup>22</sup> EA	
1236781	For 170' Tarps	\$1,799 <sup>22</sup> EA	

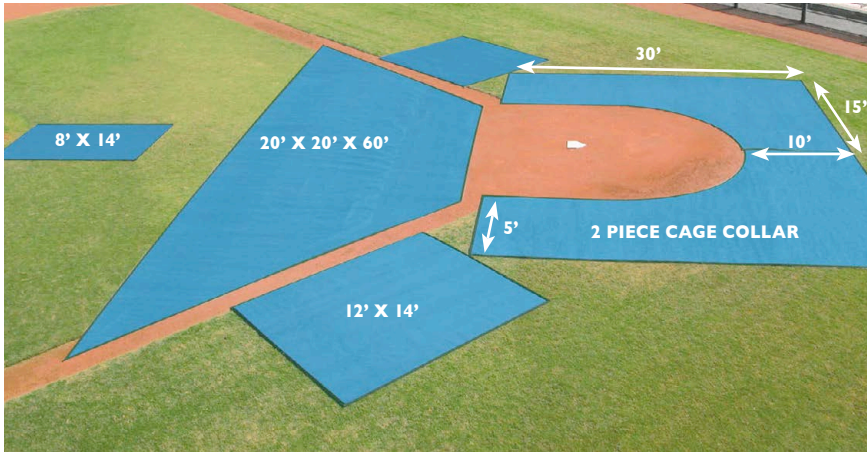

### BP ZONE® BATTING PRACTICE TURF PROTECTORS

- Tough 20 mil. VIPOL® Matrix Mesh provides the highest level of spike protection for turf
- Same material as used by top high schools, NCAA, Major League Baseball and NFL teams
- All edges are hemmed and grommeted
- Complete set includes 8' x 14' blanket, 2 piece cage collar, two -12' x 14' blankets for fungo areas and a 20'W x 20'D x 60' across trapezoid shaped infield protector
- Available in 20 colors - see color bar below
- Chroma-Bond® imprinting available and sold separately

I159899	Complete Set	\$1,799 <sup>22</sup> SET	
I159905	2 Piece Cage Collar Only	\$789 <sup>22</sup> PR	
I159912EA	Individual 8' x 14' Turf Mat	\$129 <sup>22</sup> EA	
I159929EA	Individual 12' x 14' Turf Mat	\$194 <sup>22</sup> EA	
I159837	20'W x 20'D x 60' L	\$849 <sup>22</sup> EA	



### BP ZONE® PREMIUM TURF PROTECTOR

- Made of spike resistant 20 mil VIPOL® Matrix Mesh
- Perimeter edges are hemmed and grommeted
- 20 standard colors: see color bar
- Chroma-Bond® multicolor imprinting is available

I159806	20'W x 15'D x 50'L	\$714 <sup>22</sup> EA
I159837	20'W x 20'D x 60' L	\$849 <sup>22</sup> EA
I159868	20'W x 25'D x 70'L	\$924 <sup>22</sup> EA

Practice and Premium Turf Protectors Available in:

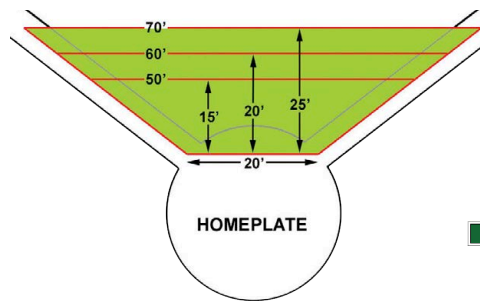

### BP ZONE® BASICTURF PROTECTOR

- Constructed of varsity level 9 oz. mesh material
- Perimeter edges are hemmed and grommeted

I273892	20'W x 15'D x 50'L	\$324 <sup>22</sup> EA
I273908	20'W x 20'D x 60'L	\$477 <sup>22</sup> EA
I273915	20'W x 25'D x 70'L	\$649 <sup>22</sup> EA

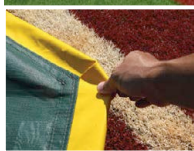

### WIND WEIGHTED® INFIELD PROTECTOR

- Protects both artificial and natural grass WITHOUT STAKES to hold it down.
- Steel chain inserted in vinyl sleeves in front, corners and back middle provide ballast that keeps the protector in position even in high winds.
- No stakes are required so installation and removal are easy.
- Made from tough 20 mil. VIPOL Matrix Mesh
- Choose from 20 colors!
- Chroma Bond imprinting is sold separately.

#### 2 Year Limited Warranty

I323559	Size - 20'W x 25'D x 70'L	\$999 <sup>22</sup> EA
I323542	Size - 20'W x 20'D x 60'L	\$899 <sup>22</sup> EA
I323535	Size - 20'W x 15'D x 50'L	\$769 <sup>22</sup> EA



### FIELD WEIGHT & TARP CART

- Designed to transport area tarps and field weights
- Includes 1 set of 36 field weights
- Heavy duty, powder coated steel construction
- 2 large pneumatic turf tires
- Tow bar and wheel barrow handles
- Fits thru a standard door

I373617	\$1,074 <sup>22</sup> EA	
---------	--------------------------	--

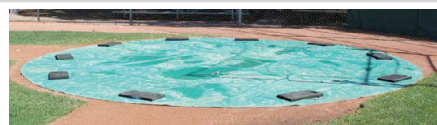

### FIELD WEIGHTS (SET OF 4)

- The perfect alternative to sand bags
- Features an easy grip handle
- Durable so they won't tear and leave a sandy mess



I373618	7 lbs each - 28lbs.	\$89 <sup>22</sup> SET
---------	---------------------	------------------------



## NEW 18 OZ PROFESSIONAL GRADE AVAILABLE



### WIND WEIGHTED FIELD TARPS

- Famous Rain covers that stay put without stakes or sandbags
- Steel chain in edge hem allows these tarps to stay down even in high winds
- Field proven to 65mph.
- Industrial 18oz. vinyl-polyester fabric with UV and mildew inhibitors
- Major League Style, rounded to fit inside dirt circle for extended use in sun and for optimum dirt moisture management
- Tarps protected by a 2 year limited warranty

#### 2 Year Limited Warranty

I323573	12' Diameter	\$399 <sup>22</sup> EA
I323580	18' Diameter	\$634 <sup>22</sup> EA
I323597	20' Diameter	\$727 <sup>22</sup> EA
I323603	26' Diameter	\$934 <sup>22</sup> EA
I323610	30' Diameter	\$1,144 <sup>22</sup> EA
I323627	10' x 10' Square	\$287 <sup>22</sup> EA

#### Repair Kit for Weighted Wind Tarps

I162974	2 sq. yards of fabric and PVC Cement.	\$84 <sup>22</sup> EA
---------	---------------------------------------	-----------------------



**NO STAKES REQUIRED!**

### INSTALLER™ DEVICE FOR WIND WEIGHTED® TARPS

- Allows two people to cover a mound in less than 30 seconds!
- PVC-aluminum pipe design with handle at each end for carrying and a second handle at end of 5' stainless steel aircraft cable for pulling
- Makes tarp storage, installation, and take-up a breeze

I162271	12' Diameter Tarp - Weight: 40 lbs	\$309 <sup>22</sup> EA
I162288	18' Diameter Tarp - Weight: 54 lbs	\$414 <sup>22</sup> EA
I162295	20' Diameter Tarp - Weight: 61 lbs	\$439 <sup>22</sup> EA
I162301	26' Diameter Tarp - Weight: 76 lbs	\$509 <sup>22</sup> EA
I162967	30' Diameter Tarp - Weight: 85 lbs	\$564 <sup>22</sup> EA

### BUNT ZONE® INFIELD PROTECTOR/TRAINER

- Widely accepted as the best bunt training aid, it teaches by visualization the correct placement of bunts for hit (yellow) or sacrifice (green). Avoid red pitcher's triangle.
- Highly spike-tolerant 9 oz. industrial vinyl-polyester mesh with UV and mildew inhibitors
- Complete with brass grommets and low profile ground stakes

I236798	Major League - 20'D x 24' x 64'	\$997 <sup>22</sup> EA
I236811	Major League - 15'D x 24' x 54'	\$924 <sup>22</sup> EA
I236804	Major League - 15'D x 18' x 48'	\$739 <sup>22</sup> EA
I162240	Minor League - 20'D x 24' x 64'	\$984 <sup>22</sup> EA
I162257	Minor League - 15'D x 24' x 54'	\$849 <sup>22</sup> EA
I162264	Minor League - 15'D x 18' x 48'	\$719 <sup>22</sup> EA



### VARSITY GRADE FIELD COVERS

- Composed of 5 oz woven polyethylene
- Super light, waterproof and mildew resistant
- Heat-sealed seams and double sewn reinforced perimeters
- Brass grommets spaced every 3'
- Ground stakes included with all covers
- Color: Green

I150575	Complete Set (1 x 26'; 1 x 20'; 3 x 10')	\$589 <sup>22</sup> SET ★
I150544	26' Circular Home Plate Cover	\$339 <sup>22</sup> EA ★
I150551	20' Circular Pitcher's Mound Cover	\$249 <sup>22</sup> EA ★
I150568	10' Square Base Covers	\$179 <sup>22</sup> SET ★

### COLLEGIATE GRADE FIELD COVERS

- Composed of 14 oz vinyl
- Heat-sealed seams and double sewn reinforced perimeters
- Brass grommets spaced every 3'
- Ground stakes included with all covers
- Color: Royal Blue

#### 2 Year Limited Warranty

I149722	Complete Set (1 x 26'; 1 x 20'; 3 x 10')	\$1,109 <sup>22</sup> SET ★
I149685	30' Circular Cover	\$734 <sup>22</sup> EA ★
I149692	26' Circular Cover	\$564 <sup>22</sup> EA ★
I149708	20' Circular Cover	\$374 <sup>22</sup> EA ★
I149715	10' Square Base Covers	\$339 <sup>22</sup> SET ★

### PROFESSIONAL GRADE FIELD COVERS

- Super durable 18oz vinyl tarp
- Brass grommets spaced every 3'
- Includes ground stakes

#### 2 Year Limited Warranty

I270051	Complete Set (1 x 26'; 1 x 18'; 3 x 10')	\$1,329 <sup>22</sup> SET
I269994	30' Circular Cover	\$859 <sup>22</sup> EA
I270006	26' Circular Cover	\$649 <sup>22</sup> EA
I270013	20' Circular Cover	\$434 <sup>22</sup> EA
I270020	10' x 10' Base Covers	\$404 <sup>22</sup> SET
I270037	18' Circular Cover	\$384 <sup>22</sup> EA
I270044	12' Circular Cover	\$184 <sup>22</sup> EA



Major League

Minor League

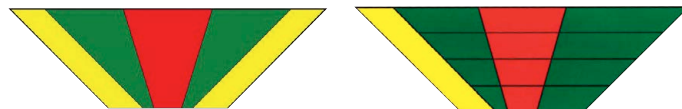

## TURF BY THE ROLL

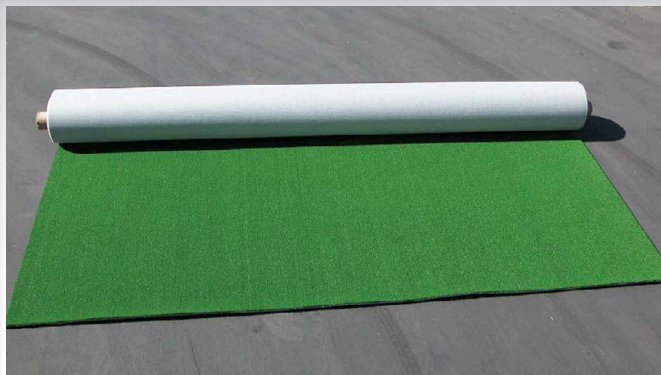
**STANDARD BATTING TUNNEL TURF ROLLS**

- Cover your batting tunnel floor with our DiamondTurf
- Available in **unitary** (with no foam padding) or **2mm foam backing**
- Rolls are 15'W x 70'L

TUNTRF1	36 oz. Turf with Unitary Backing	\$3,374 <sup>22</sup>	ROLL	
TUNTRF2	42 oz. Turf w/2mm Foam Backing	\$3,999 <sup>22</sup>	ROLL	

Cover your batting cage floor with one of our high quality Diamondturf products. We offer several grades of turf and backing to satisfy every budget and the turf can be glued down, but it is not necessary due to the size and weight of the material.

**We recommend a hitting mat for the home plate area.**

**ACTION 35 DIAMONDTURF**

- Top quality nylon turf, will hold up to most steel cleat traffic
- Turf is 35 oz., 1/2" pile height with a unitary, carpet style backing
- Hitting mat is recommended in the home plate area

1341966	By the square foot	\$3 <sup>24</sup>	SQ.FT	
1323900	15'W x 55'L Roll	\$2,299 <sup>22</sup>	ROLL	
1323917	15'W x 70'L Roll	\$2,899 <sup>22</sup>	ROLL	

**SUPREME 36 DIAMONDTURF**

- Top quality turf, will hold up to moderate steel cleat traffic
- Turf is 36 oz., 1/2" high pile with a 5mm foam backing
- Hitting mat is recommended in the home plate area

1235869	By the square foot	\$4 <sup>22</sup>	SQ.FT	
1323887	12'W x 55'L Roll	\$2,750 <sup>02</sup>	ROLL	
1323894	12'W x 70'L Roll	\$3,449 <sup>26</sup>	ROLL	

**ACTION PLUS 35 DIAMONDTURF**

- Top quality nylon turf, will hold up to moderate steel cleat traffic
- Turf is 35 oz., 1/2" pile height with a 5mm foam backing
- Hitting mat is recommended in the home plate area

1341997	By the square foot	\$4 <sup>24</sup>	SQ.FT	
1341973	15'W x 55'L Roll	\$3,599 <sup>22</sup>	ROLL	
1341980	15'W x 70'L Roll	\$4,499 <sup>22</sup>	ROLL	

**DELUXE DIAMONDTURF**

- Very good quality turf, will hold up to some steel cleat traffic
- Turf is 24 oz., 11/32" pile height with a 5mm foam backing
- Hitting mat is recommended in the home plate area.

1235876	By the square foot	\$4 <sup>14</sup>	SQ.FT	
1323863	12'W x 55'L Roll	\$2,449 <sup>22</sup>	ROLL	
1323870	12'W x 70'L Roll	\$2,950 <sup>02</sup>	ROLL	

**ELITE 45 DIAMONDTURF**

- Best quality nylon turf, will hold up to some steel cleat traffic
- Turf is 45 oz., 5/8" pile height with a unitary, carpet style backing
- Hitting mat is recommended in the home plate area

1342024	By the square foot	\$3 <sup>42</sup>	SQ.FT	
1342000	15'W x 55'L Roll	\$2,549 <sup>22</sup>	ROLL	
1342017	15'W x 70'L Roll	\$3,199 <sup>22</sup>	ROLL	

**STANDARD DIAMONDTURF**

- Good quality turf, not designed for steel cleat traffic
- Turf is 25 oz., 5/16" pile height with a 3mm foam backing
- Economical option for a batting cage when a hitting mat is used in the home plate area

1235883	By the square foot	\$3 <sup>24</sup>	SQ.FT	
1323849	12'W x 55'L Roll	\$1,888 <sup>02</sup>	ROLL	
1323856	12'W x 70'L Roll	\$2,500 <sup>01</sup>	ROLL	

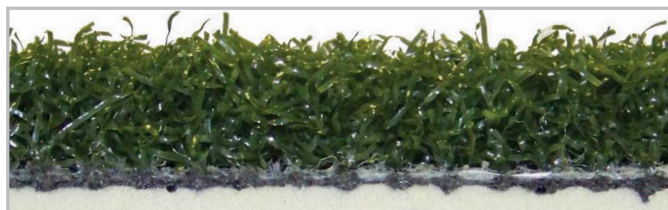
**ELITE PLUS 45 DIAMONDTURF**

- Best quality nylon turf, will hold up to some steel cleat traffic
- Turf is 45 oz., 5/8" pile height with a 5mm foam backing
- Hitting mat is recommended in the home plate area

1342055	By the square foot	\$5 <sup>24</sup>	SQ.FT	
1342031	15'W x 55'L Roll	\$3,799 <sup>22</sup>	ROLL	
1342048	15'W x 70'L Roll	\$4,799 <sup>22</sup>	ROLL	

## TURF MATS

-All Turf Mats are Constructed with 36 oz. Rugged 5mm foam backing

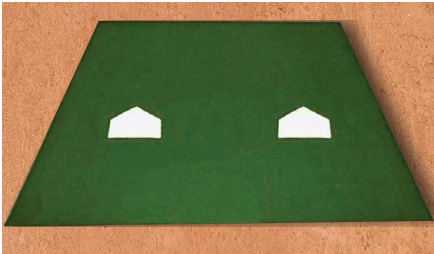

### DIAMONDTURF BULLPEN MAT

- Comes with 2 side-by-side home plates
- Standard turf green only

1235944 12' x 12' - Weight: 135 lbs \$774<sup>22</sup> EA

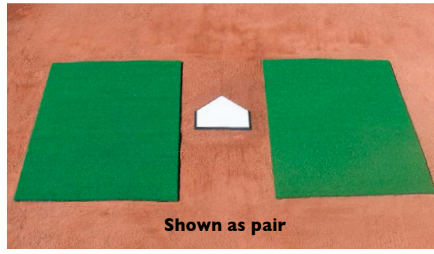

Shown as pair

### DIAMONDTURF BATTER'S MATS

- Standard turf green only

1235951 Baseball - 4' x 6' - Weight: 22 lbs. \$199<sup>22</sup> EA  
1235968 Softball - 3' x 7' - Weight: 20 lbs. \$174<sup>22</sup> EA

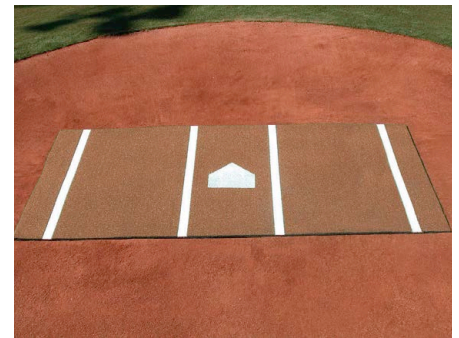

CLAY

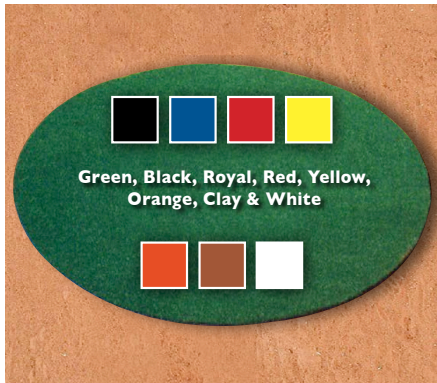

Green, Black, Royal, Red, Yellow,  
Orange, Clay & White

### DIAMONDTURF 6' ON-DECK CIRCLE

- Weight: 40 lbs per pair

1235975 Green \$449<sup>22</sup> PR  
1234346 Please Specify Color \$449<sup>22</sup> PR



### DIAMONDTURF PITCHER'S MATS

- Standard turf green only

1235920 4' x 12' - Weight: 30 lbs \$299<sup>22</sup> EA  
1235937 6' x 12' - Weight: 58 lbs \$399<sup>22</sup> EA

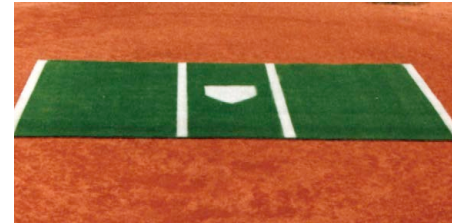

GREEN

### HOME PLATE MATS

- For indoor/outdoor cages and on-the-field BP
- Will hold up to moderate spike-cleat traffic.
- Features a thick foam backing with inlaid white turf lines
- Comes with a heavy-duty throwdown home plate

1235890 Baseball (Clay) - 6' x 12' \$459<sup>22</sup> EA  
1235906 Baseball (Green) - 6' x 12' \$459<sup>22</sup> EA  
1235913 Softball (Green) - 7' x 12' \$499<sup>22</sup> EA

### BP MAT WITH CATCHERS EXTENSION

- Attached with a six-foot-long sewn-on Velcro strip
- Velcro on both sides of the extension so the mat can be rotated for maximum use and minimum wear
- Heavy duty design will hold against a batter's twisting
- Easily rolled up and stored

1373619 Green \$599<sup>22</sup> EA  
1373620 Clay \$599<sup>22</sup> EA

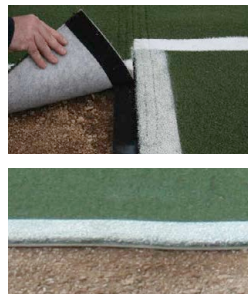

### DIAMONDTURF HALO MATS

- Made from spike proof DiamondTurf
- Eliminates turf replacement and the need for constant maintenance around home plate
- Kits come pre-cut to fit a 13' radius from the rear point of home plate
- Requires a concrete or asphalt base under turf
- Comes with either a unitary (carpet without padding) backing or with a 5mm foam pad backing
- Green turf only

1347074	5' Halo Kit without wings (unitary backing)	\$5,299 <sup>22</sup> EA	
1347081	5' Halo kit with wings (unitary backing)	\$5,899 <sup>22</sup> EA	
1347098	10' Halo Kit without wings (unitary backing)	\$6,299 <sup>22</sup> EA	
1347104	10' Halo Kit with wings (unitary backing)	\$8,499 <sup>22</sup> EA	
1347111	5' Halo Kit without wings (foam pad backing)	\$6,199 <sup>22</sup> EA	
1347128	5' Halo Kit with wings (foam pad backing)	\$6,599 <sup>22</sup> EA	
1347135	10' Halo Kit without wings (foam pad backing)	\$7,999 <sup>22</sup> EA	
1347142	10' Halo Kit with wings (foam pad backing)	\$8,799 <sup>22</sup> EA	
1347159	1 Color Letter in 5' halo	\$129 <sup>22</sup> EA	
1347166	2 Color Letter in 5' halo	\$199 <sup>22</sup> EA	
1347173	1 Color Letter in 10' halo	\$219 <sup>22</sup> EA	
1347180	2 Color Letter in 10' halo	\$379 <sup>22</sup> EA	



2-COLOR LETTERING ON 10' HALO KIT WITH WINGS



## JOX BOX

(photos show Jox Box prior to installation)

Eliminates holes in batter's boxes, in pitcher's area, and in front of bases. After proper installation, the Jox Box is low maintenance. Durable design resists steel cleats and is waterproof. Your field material is brushed into surface after installation to create a smooth transition. All are shipped motor freight.

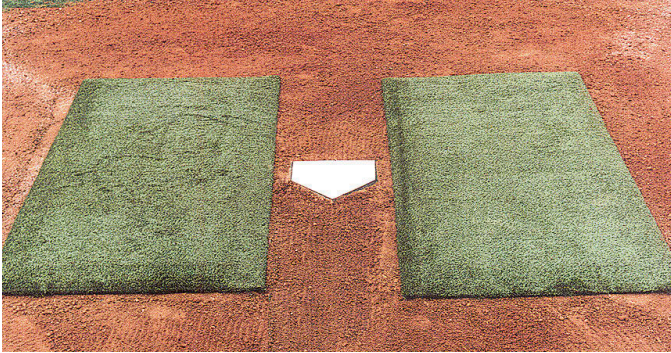

### BATTERS BOX

- Eliminates holes in batters boxes, in pitcher's area, and in front of bases
- After proper installation, the Jox Box is low maintenance
- Durable design resists steel cleats and is waterproof
- Size is 4' x 8' overall, 3' x 7' exposed after installation

1235814 Set of 2 \$1,399<sup>22</sup> PR

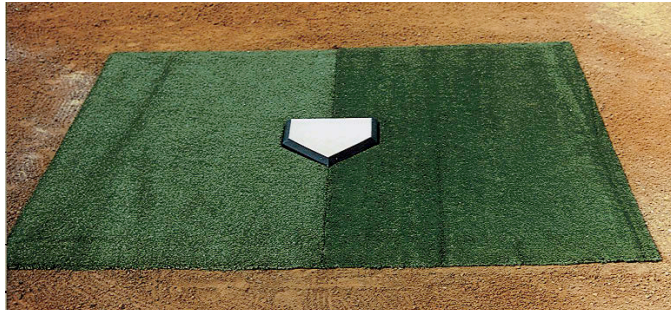

### DELUXE BATTERS BOX

- Covers the entire homeplate area with a cut-out for homeplate
- Made in 2 pieces that butt together when installed

1235821 Full Size 8' x 10', Weight: 550 lbs \$1,699<sup>22</sup> EA

1235838 Youth Size 7' x 9' - Weight: 550 lbs \$1,599<sup>22</sup> EA



### BASEBALL PITCHERS WEDGE

- Single wedge shaped panel is 3'W at the front and 4' 9"W at the top and 5' 6"L
- To be installed in front of the pitchers rubber
- Weight: 150 lbs.

1235845 \$649<sup>22</sup> EA



### SOFTBALL PITCHERS MOUND

- Single 4' x 8' panel with a cut-out for the pitching rubber
- Weight: 200 lbs.

1235852 \$669<sup>22</sup> EA

## BELOW SURFACE

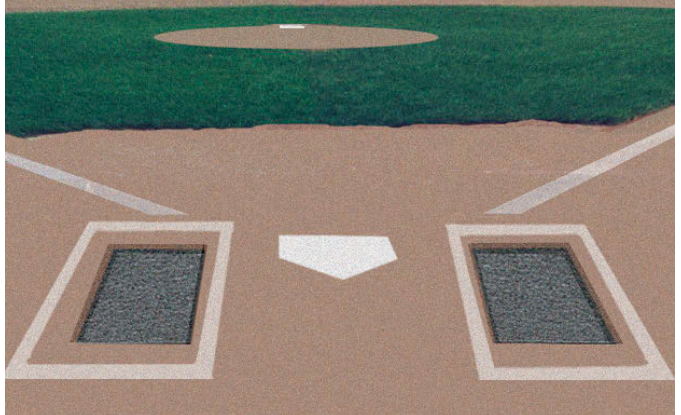

### BATTERS BOX FOUNDATION

- Recycled rubber mats
- Eliminates deep holes in box areas
- Bury under 3" - 4" of dirt or clay
- Sold in pairs

MK3240

Size - 32"L x 40"W x 3/4"D

\$349<sup>22</sup> PR

### POWER MATS

- A non-conductive, non-corrosive, composite fiberglass construction
- Designed to be permanently buried in your batter's box 3" below grade
- Rigid design will not curl
- Eliminates dangerous holes created by "digging in"
- Shown prior to installation

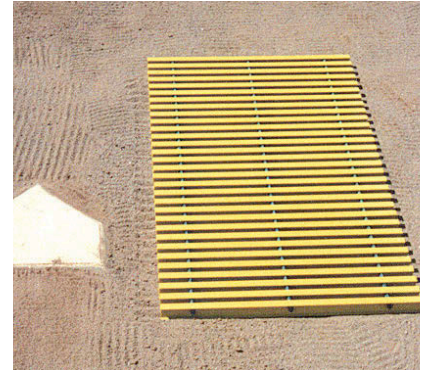

1148817 Size - 32"W x 60"L \$429<sup>22</sup> EA

Shown prior to installation

## ABOVE SURFACE



### GRATE GUARDS

- Cover your hazardous drainage grates and utility boxes with non-skid, recycled rubber covers
- Water flows through; approximately 3/4" thick
- Color: Dark Green only

1170467

Square Grate Guard - 37" x 37"

\$194<sup>22</sup> EA

1148800

Circular Grate Guard - 30" Diameter

\$174<sup>22</sup> EA



-Call for freight quote

BASEBALL/SOFTBALL



**CALCINED CLAY TOP DRESSING**

- A calcined clay product used on the skinned areas of baseball and softball fields to improve drainage
- The larger product size increases the durability of the product
- It will not stick to cleats and is easily incorporated into the infield
- 50 lb. bags/40 bags per pallet

DPROCCTD \$599<sup>22</sup> PALLET



**MOUND/HOMEPLATE CLAY BRICKS**

- Mound/ Home plate clay bricks are unfired compressed clay bricks perfect for building or repairing high stress areas
- The bricks, when watered, simply turn to firm clay to provide durability and reduced maintenance in these areas
- Brick size: 4" x 8" x 2-1/2"
- 300 bricks per pallet

DPROBI2 \$739<sup>22</sup> PALLET



**RED INFIELD CONDITIONER**

- A vitrified clay (expanded shale and clay) product applied to skinned areas of baseball and softball fields
- Red infield conditioner helps create a natural look that enhances the appearance of an infield
- 50 lb. bags/40 bags per pallet
- Bulk delivery is available upon request

DPROIC \$499<sup>22</sup> PALLET



**ATHLETIC FIELD MARKING DUST**

- Bright premium marking dust complies with the NCAA rules
- Non-toxic, non-burning and harmless to soil and turf
- 50 lb. bags/40 bags per pallet

DPROMD \$559<sup>22</sup> PALLET



**MOUND/HOMEPLATE CLAY**

- Mound/ Home plate clay is a screened clay loam with a rich red color, which easily conforms and binds to the existing surface
- The loose clay easily tamps into holes providing greater durability and less maintenance
- 50 lb. bags/40 bags per pallet

DPROCL \$539<sup>22</sup> PALLET



**CALCINED CLAY DRYING AGENT**

- A calcined clay product used to quickly dry puddles and muddy conditions
- The finer gradation has more surface areas to dry the field faster, reducing rain delays
- It will not stick to cleats and is easily incorporated into the infield
- 50 lb. bags/40 bags per pallet

DPROCCDA \$599<sup>22</sup> PALLET



**LARGE STRING WINDERS**

- High impact plastic reel
- 740' of heavy duty nylon twine
- 10" steel spike

1323443 Hand Held Model - Black \$37<sup>22</sup> EA  
1323450 Caddy Model - Orange \$47<sup>22</sup> EA



**LINE MATE STRING WINDER**

- Lightweight, easy to use tool for layout and lining baseball/softball fields.
- Comes complete with permanent distance markers on cable, extra cord for foul lines, hammer and 2 spikes.
- Cable is 130', cord 240', distance marks at 45', 60', 90', 127' 3-3/8"

1297607 Orange Pro Model \$149<sup>22</sup> EA



**HAND HELD STRING WINDER**

- Durable ABS case keeps the string fully enclosed to prevent damage
- Wound by one person
- The nail stores on the side of the unit for safety
- Comes with 450' of durable nylon twine

1265804 \$29<sup>22</sup> EA ★



**CLEAT AND SPIKE CLEANER**

- Durable molded PVC construction
- UV protected to withstand outdoor conditions
- Extended side panel
- Built in handle for easy transport

1186796 19" x 14" \$46<sup>22</sup> EA ★

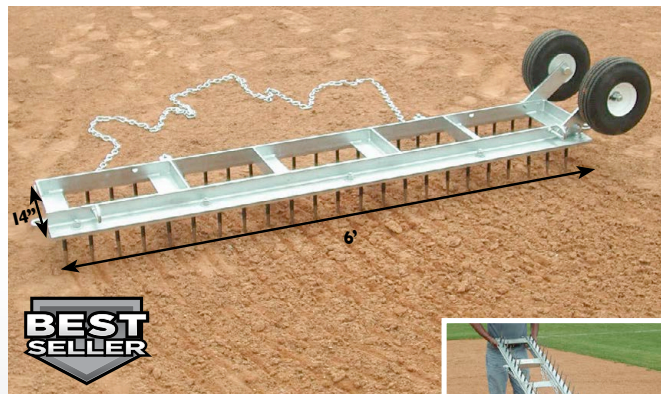

**DIAMOND DIGGER FIELD GROOMER**

- Hot dipped galvanized steel frame
- Uses 4.5" sharpened and hardened steel cutting teeth
- No-flat wheels allow you to roll for transport
- Pull chain is provided
- Hooks on rear allows for attachment of drag mat
- Remove wheels to turn groomer over and use as a leveling sled
- Recommended to be pulled by a tractor



<b>BSDDRAG</b>	Diamond Digger w/Wheels, Wt 100 lbs.	\$529 <sup>22</sup> EA ★	
<b>BSDDWHL</b>	Set of 2 Wheels	\$164 <sup>22</sup> EA ★	
<b>I275216</b>	Repl. Teeth for Diamond Digger	\$124 <sup>22</sup> PACK ★	

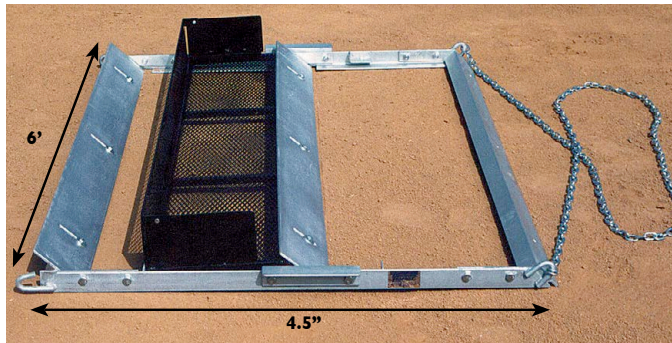

**CUT N' LEVEL DRAG**

- The Cut-N-Level drag is designed for grooming the surface of playing fields
- Features flat steel cutting blades and a screen for rock removal
- Made from 16 gauge metal, the cutting blades are slotted and attached to the main frame with bolts, allowing the operator to adjust the blades for the desired depth of cut
- Used in routine maintenance, the Cut-N-Level drag can be used for rock removal, smoothing and leveling the field as the need arises, saving hundreds of man-hours normally needed to do these jobs
- Frame and blades are galvanized
- Weight: 220 lbs.

<b>BSCLDRAG</b>	Size - 6'W x 4'6"L	\$979 <sup>22</sup> EA ★	
-----------------	--------------------	--------------------------	--



**BUY THE COMBO AND SAVE!**

**DIAMOND DIGGER FIELD GROOMER - COMBO**

- Purchase the Diamond Digger together with our Heavy Duty drag mat (I149821) and save

<b>BSDDRAGC</b>	Complete Combo	\$699 <sup>22</sup> EA ★	
-----------------	----------------	--------------------------	--



**5' x 3' PREMIUM NAIL DRAG**

- Welded steel frame supports 117 - 6"L x 1/4"D grooming nails
- Wheels and tongue make moving and storing these units easy
- Comes complete with 6'W x 18"L rigid drag mat
- All attachments, hardware and pull chains are included
- Frame size 5' x 3'. Weight: 120 lbs.

<b>BS53DRAGC</b>	Nail Drag w/ Rigid Drag Mat (shown)	\$979 <sup>22</sup> EA ★	
<b>BS53DRAG</b>	Nail Drag w/ Drag Chain only	\$859 <sup>22</sup> EA ★	
<b>BS53NAIL</b>	Replacement Nails (pack of 117)	\$99 <sup>22</sup> EA	

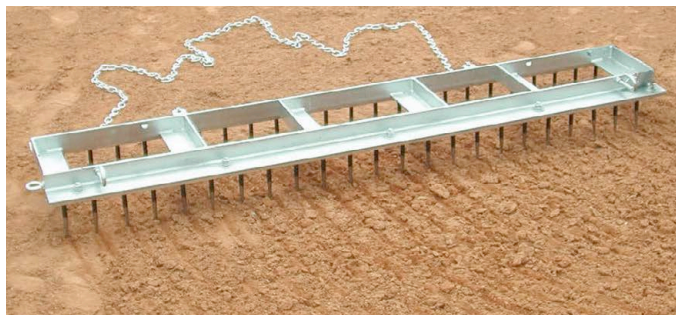

**BIG LEAGUE FIELD DRAG**

- Designed to break up dirt or cinders on the baseball field or track
- Features forty-six 4.5" steel cutting teeth
- Frame is hot dipped galvanized steel
- Heavy duty pull chain included
- Recommended to be pulled by a tractor
- Grooming drag chain included
- Flip over and use as leveling drag
- Weight : 88 lbs.

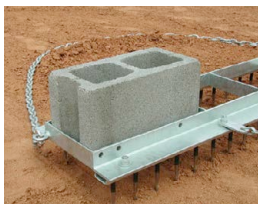

<b>BSDRAG</b>	Size - 14"W x 6'L	\$449 <sup>22</sup> EA ★	
---------------	-------------------	--------------------------	--



**NEW STRIPE**

**DIRT MEDIC WITH BRUSH**

- Break-up packed surface and level ridges and ruts
- Can be towed with garden tractors, ATV's or light utility vehicles
- Weighs less than 200lbs.
- Teeth may be completely raised to use just the blade and/or broom

1378377	32"W x 62"L x 36"H	\$1,699 <sup>22</sup> EA	
---------	--------------------	--------------------------	--



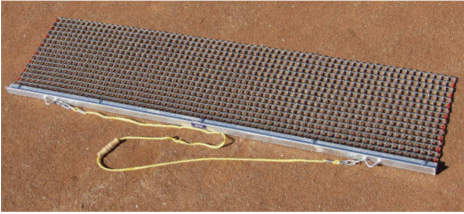

### RIGID DRAG MATS

- Rugged all-steel drag mats have 1" x 1" mesh with 13 gauge galvanized connecting rods
- Mesh material is 3/8" x .050 galvanized steel
- Cannot be rolled up for storage
- Includes heavy-duty angle iron across front of mat and a rope with handle for pulling

<b>DMATR6X3</b>	6'W x 3'L, Wt 44 lbs.	\$269 <sup>22</sup> EA ★
<b>DMATR6X18</b>	6'W x 18"L Weight: 35 lbs.	\$194 <sup>22</sup> EA ★
<b>DMATR4X3</b>	4' W x 3' L, Weight: 36 lbs.	\$214 <sup>22</sup> EA ★
<b>DMATR4X18</b>	4' W x 18" L Weight: 24 lbs.	\$164 <sup>22</sup> EA ★

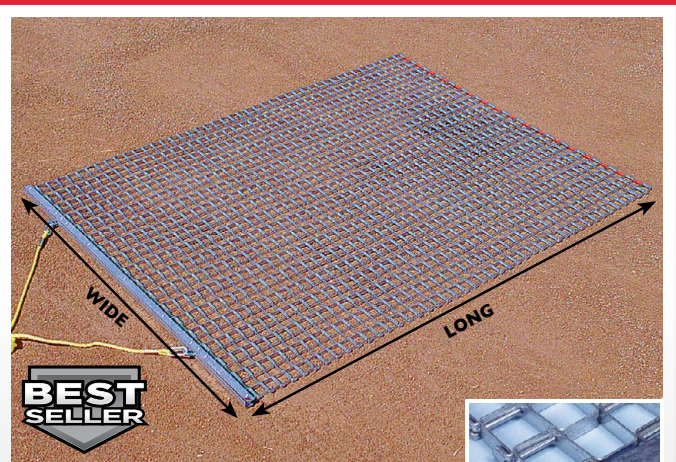

### ALL-STEEL DRAG MATS

- Workhorse, all-steel drag mat comes complete with drag bar and pull rope
- Mesh material is 3/8" x .050 galvanized steel
- Perfect for general grooming and maintenance

<b>DMAT3X5</b>	Size - 3'W x 5'L - Weight: 28lbs.	\$154 <sup>22</sup> EA ★
<b>DMAT3X4</b>	Size - 3'W x 4'L Weight: 23lbs.	\$129 <sup>22</sup> EA ★
<b>DMAT6X3</b>	Size - 6'W x 3'L Weight: 38lbs.	\$227 <sup>22</sup> EA ★
<b>DMAT6X6</b>	Size - 6'W x 6'L Weight: 64lbs.	\$334 <sup>22</sup> EA ★
<b>BBMAT106</b>	Size - 10'W x 6'L Weight: 97 lbs.	\$454 <sup>22</sup> EA ★ <b>SeH</b>



### COCOA DRAG MATS

- Constructed from natural cocoa fibers that "float" across the surface producing a beautiful finish with minimal buildup of your infield mix
- Solid-steel twin blade cutting edge to level rough spots
- Great on turf to break up core aeration plugs and smooth in top-dressing materials
- Handle grip for easy transport

<b>1091540</b>	Standard Cocoa Drag - 4' x 2'	\$224 <sup>22</sup> EA
<b>1091557</b>	Large Cocoa Drag - 6' x 2'	\$264 <sup>22</sup> EA
<b>1091564</b>	Jumbo Cocoa Drag - 6' x 4'	\$399 <sup>22</sup> EA

### 6' CUTTING BAR (WITH DRAG)

- Unique 6' asymmetrical cutting bar levels & smooths rough spots and eliminates ridge build-ups
- The cutting bar is sized to match our 6' x 6' drag mats
- Includes quick-link attachments
- Combo unit includes cutting bar and 6' x 6' drag (DMAT6X6)



<b>1237009</b>	Cutting Bar only	\$164 <sup>22</sup> EA
<b>1273410</b>	Cutting Bar w/drag combo	\$499 <sup>22</sup> EA ★

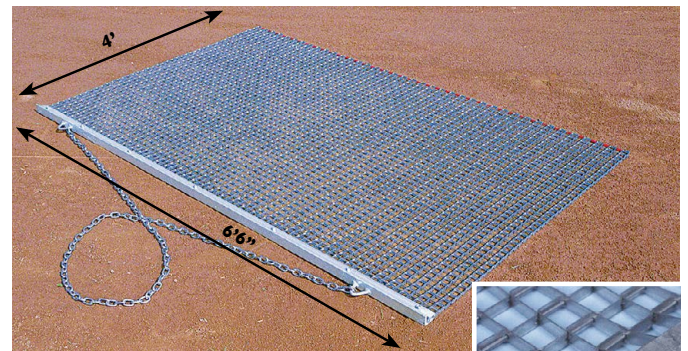

### HEAVY DUTY DRAG MAT

- Mesh is 3/8" x .050 galvanized steel
- Includes heavy duty angle iron across front of mat and a heavy duty chain for tractor pulling
- Weight: 68 lbs.

<b>1149821</b>	Size - 66"W x 4'L	\$399 <sup>22</sup> EA ★
----------------	-------------------	--------------------------

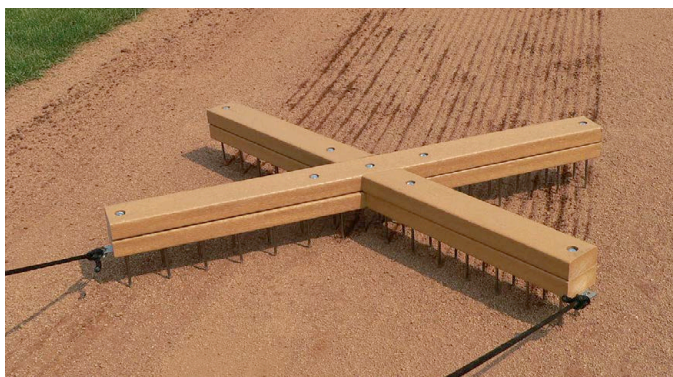

### HAND NAIL DRAG

- Ideal for scarifying baselines, cutouts and home plate areas, as well as daily nail dragging of infield skin
- Constructed of plastic lumber and hardened 1/4" steel spikes and can be pulled in either the 3'W or 2'W direction by simply changing the tow rope connection point
- Pull rope included

<b>1236996</b>	Size - 3' x 2'	\$339 <sup>22</sup> EA
----------------	----------------	------------------------

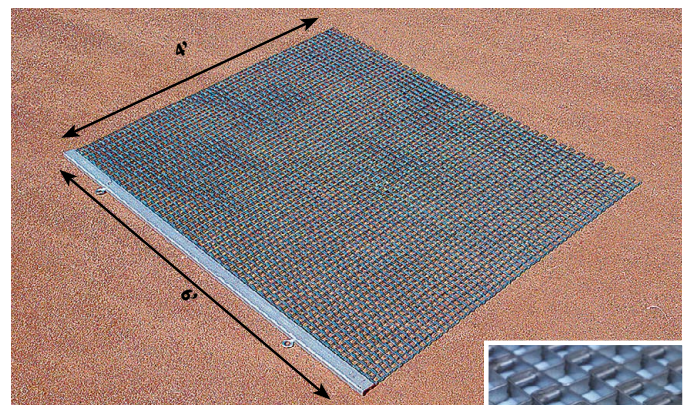

### MONSTER DRAG MAT

- Deluxe mat construction utilizes 1/2" x .062 mesh with 6 gauge connecting rods, each welded on end
- Includes angle iron front with welded eye bolts to attach your chain

<b>1159608</b>	Size - 6'W x 4'L	\$429 <sup>22</sup> EA ★
----------------	------------------	--------------------------

**TAMP**

- Tamp base is made of 1/2"-thick steel plate
- Covers a 12" x 12" area
- Heavy duty 48" steel handle

BBTAMPBM

\$79<sup>22</sup> EA ★**TAMP COVER**

- Designed to make tamping wet clay a simple, hassle free process as the cover does not allow wet dirt to stick to the tamp plate.
- Fits 12" x 12" tamp.

1088137

\$39<sup>22</sup> EA**SUPER SOPPER**

- Pick up water & carry it away from playing surface
- For grass, tennis courts or artificial turf

BBSSMCKR 7 gallon holding tank \$799<sup>22</sup> EA  
 BBSDLPH 14 gallon holding tank \$999<sup>22</sup> EA

**INFIELD FINISHING MOPS**

- Designed for those small areas that are nearly impossible to finish grooming
- Great for pitching mounds, batters boxes, base paths, on-deck circles, and any other cutouts
- 2'W x 18"D mats are available in your choice of either a high quality cocoa mat or super-duty flexible steel mat.
- 66" handles & other components are constructed from heavy-duty reinforced aluminum.

1091533

Flex Steel Mop

\$159<sup>22</sup> EA

1091526

Cocoa Mop

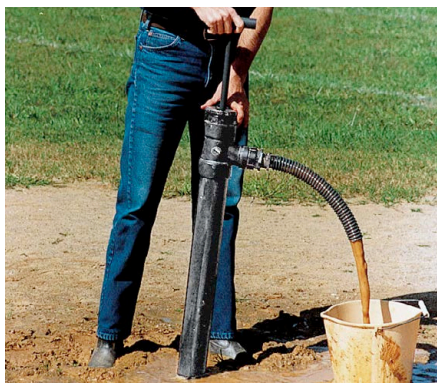
\$184<sup>22</sup> EA**DIAMOND PUMP**

- Pump puddles away at 18-20 gallons per minute with this amazing non-clogging hand pump
- Needs 2" of water to be most efficient but will draw water down to less than 1/2"

BBDMMP

Complete unit

\$144<sup>22</sup> EA

BBDMDS0H

50' Hose Attachment

\$119<sup>22</sup> EA**DOUBLE-PLAY MONSTER BROOM**

- This massive 84" broom has an aggressive scarifying edge for breaking up packed soils while the broom gives your playing surface a professional look.

200182384

\$269<sup>22</sup> EA**THREE-ROW MONSTER BROOM**

- 7' broom is excellent for dressing softball or baseball infields
- May also be used for sweeping warehouse floors, tennis courts and pavement
- Made with heavy-duty aluminum construction

BBDRGBRM

\$249<sup>22</sup> EA**ECONOMY HAND WATER PUMP**

- Removes water quickly at 8 - 10 gallons per minute
- 36"H x 1-3/4"D pump with 6'L x 1-1/4"D outlet hose
- Made from high-impact PVC

1242324

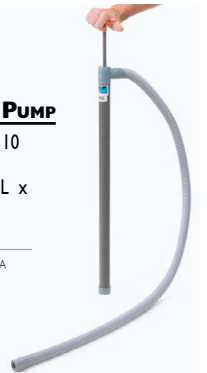
\$59<sup>22</sup> EA**PUDDLE PILLOW**

- The Puddle Pillow is a reusable, lightweight pillow that can absorb up to 3.5 liters of water from puddles
- Place the pillow in standing water, remove from the area and squeeze out the absorbed water.

20026531

\$119<sup>22</sup> CASE OF 10**LEVELING BOARD**

- 54" width
- Ideal for levelings infield, bases, home plate & pitchers mound
- Leaves smooth finish on wet or dry field
- Heavy duty aluminum handle
- Steel cutting edge for filling high & low spots.

1149005

\$189<sup>22</sup> EA ★



### **INFIELD LIP BROOM**

- Heavy duty 28" broom head with two rows of replaceable bristles and 5' powder-coated aluminum handle, bent to reduce back strain
- Ideal for brushing top-mix out of turf
- Use back side to scrape and break-up hard dirt

1148497      Size - 28"W      \$144<sup>22</sup> EA



### **LOOP HOE EDGER**

- Double knife edge rocks back and forth with a push/pull motion
- Excellent for cultivating, aerating and weeding
- Replaceable blade
- 60" powder-coated aluminum handle
- 6" non-slip vinyl grip

1184716      \$39<sup>22</sup> EA



### **ALUMINUM MAINTENANCE RAKE**

- All aluminum construction
- Durable and lightweight with oversized teeth for easy field grooming & pit maintenance
- Use one side to rake and the other side to level
- 58" long handle

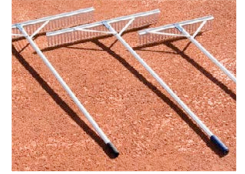

1196238	Size - 24"W	\$59 <sup>22</sup> EA ★
1196245	Size - 36"W	\$69 <sup>22</sup> EA ★
1196252	Size - 48"W	\$79 <sup>22</sup> EA ★



**Breaks Down For Easy Storage!**

### **BASERUNNER RAKE**

- Heavy duty rake has a telescopic handle that adjusts from 39" to 70" and breaks down for convenient storage
- The high grade aluminum head was designed specifically for the sports turf industry

200112503      Size - 36"W      \$99<sup>22</sup> EA



### **OVERSEED ENHANCING TOOL**

- 12 self-sharpening steel star wheels penetrate any compacted soil
- Perfect for overseeding wear areas on your field
- Creates excellent seed-to-soil contact, critical for successful germination
- 9"W head w/60" steel handle.

1149012      \$54<sup>22</sup> EA ★



### **PRO LUTE RAKE**

- Saw-tooth design makes this tool ideal for breaking-up and grading soil and top dressing
- Magnesium/aluminum head with strong wrap around bracing
- 82" powder-coated handle connected to head with solid metal plug

BBFLDLTE	Size - 36"W	\$84 <sup>22</sup> EA
1237016	Size - 30"W	\$84 <sup>22</sup> EA



### **SIFTING SCOOP**

- Perfect tool for cleaning rocks, glass and unwanted debris from dirt and sand
- Lightweight one piece molded construction
- Scoop head is 14" x 17"

1273922      \$99<sup>22</sup> EA

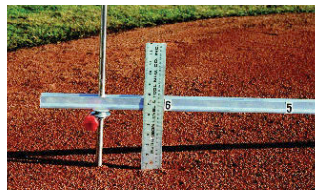

### **MOUND SLOPE GAUGE**

- This popular mound building tool is the most accurate way to ensure proper height and taper
- Includes bubble level, metal ruler, 2 support rods and complete instructions for mound construction and maintenance

1148992      \$269<sup>22</sup> EA



### **DOUBLE PLAY RAKE**

- Short teeth break up the hard clay
- Longer teeth sift the top soil for general grooming

1234985	Size - 24"W	\$79 <sup>22</sup> EA ★
1234992	Size - 36"W	\$89 <sup>22</sup> EA ★

## SPRAY NOZZLES



### SPRAY NOZZLES

- |                   |                          |                       |                       |                                |                       |
|-------------------|--------------------------|-----------------------|-----------------------|--------------------------------|-----------------------|
| 1. <b>1291278</b> | Fits 1" hose             | \$69 <sup>22</sup> EA | 4. <b>B55-1342062</b> | Flat/Stream Spray-Fits 1" hose | \$79 <sup>22</sup> EA |
| 2. <b>1237108</b> | Aluminum-Fits 1" hose    | \$99 <sup>22</sup> EA | 5. <b>1291292</b>     | Fits 3/4" hose                 | \$59 <sup>22</sup> EA |
| 3. <b>1291285</b> | HD Aluminum-Fits 1" hose | \$99 <sup>22</sup> EA |                       |                                |                       |

### SHOWER HEAD NOZZLE

- Great tool for watering select areas
- Fits 3/4" or 1" hose
- Up to 55 GPM

**K10598** \$26<sup>22</sup> EA



### MAGNUM STEEL SPRAY NOZZLE

- Mist to stream pattern
- Delivers up to 30 gallons per minute
- Fits 3/4" and 1" hoses
- Adapter included

**K10270** \$69<sup>22</sup> EA



## QUICK COUPLER FIXTURE KIT (3/4" OR 1")

Includes quick coupler that attaches permanently to your 3/4" or 1" water line. Attach your water hose, the key handle and the brass swivel together. Insert the key handle into the quick coupler push down and turn to lock in and release the water through the hose. Reverse the procedure to turn the water off.

### FOR 3/4"

- Quick coupler, key handle and brass swivel for 3/4" hose

**1376454** \$84<sup>22</sup> SET

- Extra 3/4" brass swivel

**1376456** \$29<sup>22</sup> EA

- Extra key handle for 3/4" coupler

**1376455** \$24<sup>22</sup> EA

- Optional 3/4" impact sprinkler with coupler
- Attaches to key handle for use in quick coupler or roller pro portable sprinkler base

**1376457** \$49<sup>22</sup> EA

### FOR 1"

- Comes with quick coupler, key handle and brass swivel

**1376458** \$139<sup>22</sup> SET

- Extra key handle

**1376459** \$44<sup>22</sup> EA

- Extra brass swivel

**1376460** \$39<sup>22</sup> EA

- Optional 1" impact sprinkler with coupler
- Attaches to key handle for use in quick coupler or roller pro portable sprinkler base

**1376461** \$89<sup>22</sup> EA

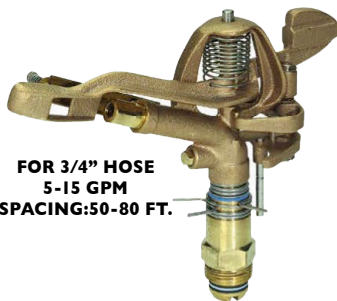

FOR 3/4" HOSE  
5-15 GPM  
SPACING:50-80 FT.

### FOR 3/4" HOSE

#### BRASS SWIVEL



#### KEY HANDLE



#### QUICK COUPLER

## HOSES



### ENDURO HOSE REEL KIT



- Heavy duty steel frame
- Large 16" rear wheels for easy transport
- Includes 6' long supply hose
- Accommodates 150' of 1" hose
- Complete Kit includes: Enduro Hose Reel, 1" x 100' Quick Wetdown Water Hose (1275179) and 1" Pro Spray Nozzle (1237108)

**1275186** Complete Kit \$599<sup>22</sup> EA

**MSHREEL** Hose Reel Only \$439<sup>22</sup> EA ★



### 1" BALL PARK HOSES AND KITS

- 1" I.D. heavy-duty clear hose is used by top level facilities throughout the country
- Handles 150 psi operating pressure and 600 lb. burst pressure
- Hose kit includes: hose, hose key, quick connect, spray nozzle and swivel

MSHOSE50	50' Hose Kit	\$569 <sup>22</sup> EA
MSHOSE75	75' Hose Kit	\$599 <sup>22</sup> EA
MSHOSE00	100' Hose Kit	\$689 <sup>22</sup> EA
200101075	75' Hose Only	\$229 <sup>22</sup> EA
200101100	100' Hose Only	\$279 <sup>22</sup> EA
<b>1237108</b>	Aluminum-Fits 1" hose	\$99 <sup>22</sup> EA



### 1" QUICK WETDOWN WATER HOSES

- Heavy duty rubber hose with solid brass couplings and stainless steel bands
- Top quality construction

<b>1275162</b>	75' Hose Only	\$184 <sup>22</sup> EA
<b>1275179</b>	100' Hose Only	\$234 <sup>22</sup> EA

### 3/4" MUNICIPAL WATER HOSES

- Same quality construction as the 1" hose except diameter is 3/4"

<b>1275148</b>	75' Hose Only	\$139 <sup>22</sup> EA
<b>1275155</b>	100' Hose Only	\$169 <sup>22</sup> EA

## DRY LINE MARKERS



### 4-WHEEL LINE MARKERS W/ PNEUMATIC TIRES

- The most durable line marker on the market
  - 11 gauge steel frame
  - 18 gauge galvanized steel bucket
  - Tires measure 3.5"W x 10"D
  - Easily adjustable to either 2" or 4" lines
- 18 Month Limited Warranty**

<b>1. BBHDDM10</b>	100 lb. Capacity	\$354 <sup>22</sup> EA ★
<b>2. BBHDDM50</b>	50 lb. Capacity	\$324 <sup>22</sup> EA ★

### 4-WHEEL DRY LINE MARKERS

- All steel construction
- 4 hard rubber wheels for extra durability
- Easily adjustable to either 2" or 4" lines

<b>3. BBDLM654</b>	4-Wheel 65 lb. Capacity	\$239 <sup>22</sup> EA ★
--------------------	-------------------------	--------------------------

### 2-WHEEL DRY LINE MARKER

- All steel construction
- 2 hard rubber wheels for extra durability
- Easily adjustable to either 2" or 4" lines

<b>4. BBDLM252</b>	2-Wheel 25lb. Capacity	\$169 <sup>22</sup> EA ★
--------------------	------------------------	--------------------------



### FOLDABLE BATTER'S BOX TEMPLATES

- Lightweight aluminum frame template
- Simply line the handle up with the straight side edge of the plate and you will be square and the correct distance away from for proper alignment
- Step on template and leave a 2"W impression to chalk over
- Folds in half for easy transport

<b>BBTMPL46</b>	4' x 6' Baseball	\$299 <sup>22</sup> EA ★
<b>BSFTMPSB</b>	3' x 7' Softball	\$289 <sup>22</sup> EA ★
<b>BSFTMPLL</b>	3' x 6' Little League	\$289 <sup>22</sup> EA ★



### ADJUSTABLE BATTER'S BOX TEMPLATE

- Adjustable to 3' x 6' (youth league), 4' x 6' (big league), 3' x 7' (softball), 4' x 7' (softball)
- By positioning the two markers on either side of the plate and tracing the outside edge with a nail, you are ready to chalk
- All steel construction

<b>BSTMPLA</b>		\$299 <sup>22</sup> EA ★
----------------	--	--------------------------



### STRIPING WAND

- Use for convenient touch-up of lines or stenciling
- Sturdy, lightweight construction
- Works with Markl field striping paint

1237092	\$64 <sup>22</sup> EA
---------	-----------------------

### ATHLETIC FIELD STRIPER

- For use on grass, dirt, concrete, pavement or gravel
- Sturdy steel construction with 4 large, easy rolling wheels and a collapsible handle for easy storage
- Lightweight housing includes windscreen, fingertip on/off lever, storage for 12 extra cans and simple 2" - 4" line width adjustment
- Non-toxic aerosol spray goes straight downward for complete coverage (paint sold separately)
- Maintenance free, no messy clean up



0795XXXX	\$134 <sup>22</sup> EA
----------	------------------------



### FIELD STRIPING PAINT

- Our 3 main colors, White, Orange and Yellow will give you up to 700 feet of spray based on a 4" line
- Compare that with others that offer only 300-400 feet based on a 4" line. That's like getting 2 cans for the price of one
- Will not flake or wash away
- Cans are 17 oz. by weight

#### Case Price (12 Cans)

0792XXXX	White	\$59 <sup>22</sup>	CASE OF 12 CANS
0792ORXX	Orange	\$59 <sup>22</sup>	CASE OF 12 CANS
0792YLXX	Yellow	\$59 <sup>22</sup>	CASE OF 12 CANS
0792CXXX	Other colors - Standard Nozzle	\$79 <sup>22</sup>	CASE OF 12 CANS

#### 3 Case Master (36 Cans) Save!!

0792PACK	White	\$154 <sup>22</sup>	PACK OF 36 CANS
0792CPACOR	Orange	\$159 <sup>22</sup>	PACK OF 36 CANS
0792CPACYL	Yellow	\$159 <sup>22</sup>	PACK OF 36 CANS
0792CPAC	Other colors - Standard Nozzle	\$189 <sup>22</sup>	PACK OF 36 CANS

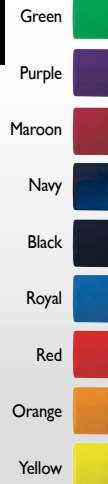

White

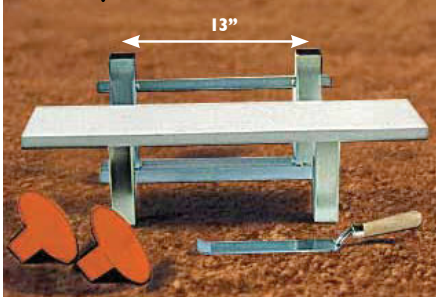
MacGregor **PITCHER'S PLATES****PROFESSIONAL REMOVABLE PITCHING RUBBER**

- All steel ground anchor to be cemented into ground
- Pitcher's rubber is bolted and silicone-sealed to the top stanchion
- Comes with two rubber anchor plugs and an anchor digout tool

**BSPIGP** Official Size - 6" x 24" \$167<sup>22</sup> SET ★

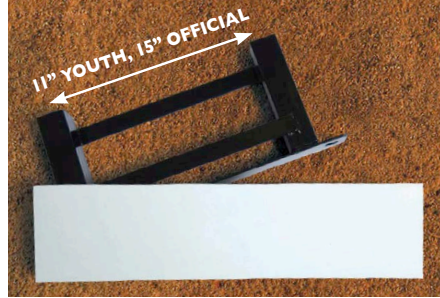
**REMOVABLE PITCHER'S PLATE & ANCHOR**

- Semi-permanent anchoring system
- Powder coated steel stanchion bolted to the pitcher's rubber

**BSIGPPSR** Complete Set - Official Size 6" x 24" \$42<sup>22</sup> EA ★  
**I033434** Official Ground Anchor w/ Insert \$29<sup>22</sup> EA ★  
**I033465C** Complete Set - Youth Size 4" x 18" \$39<sup>22</sup> SET ★  
**I033441** Youth Ground Anchor w/ Insert \$27<sup>22</sup> EA ★

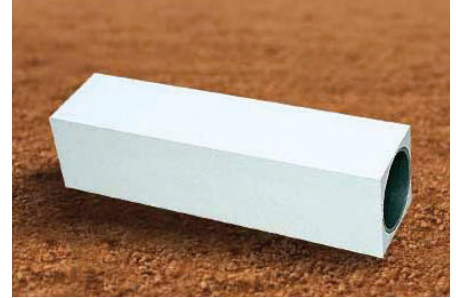
**4-WAY PITCHER'S RUBBER**

- Comes complete with inner support tubing
- Designed to be rotated periodically for extended life

**BBPR4WAY** Official Size - 6" x 24" \$99<sup>22</sup> EA ★  
**BBPR4YTH** Youth Size - 4" x 18" \$79<sup>22</sup> EA ★

**PITCHER'S RUBBER**

- Solid white molded rubber
- Includes three metal spikes

**BBPPLATE** Official Size - 6" x 24" \$18<sup>22</sup> EA ★  
**BBPPLLXXY** Youth Size - 4" x 18" \$15<sup>22</sup> EA ★

**END SPIKED PITCHING RUBBERS**

- Spikes go through steel tabs for easy installation
- Includes 4 spikes

**I147902** Official Size - 6" x 24" \$26<sup>22</sup> EA ★  
**I148466** Youth Size - 4" x 18" \$19<sup>22</sup> EA ★  
**I148473** Extra Hammer Spikes \$9<sup>22</sup> PACK OF 4 ★

**STEP DOWN PITCHER'S RUBBER**

- Wooden core with solid molded cover and front extension to prevent holes in the front of the plate and reduce maintenance
- No stakes or spikes required

**BBPRPROX** Official Size - 6" x 24" \$79<sup>22</sup> EA ★  
**BBPRPROY** Youth Size - 4" x 18" \$69<sup>22</sup> EA ★

MacGregor **HOME PLATES****WAFFLE STYLE IN-GROUND HOME PLATE**

- All rubber construction
- Waterproof with non-skid surface.

**BBHPSAFW** \$64<sup>22</sup> EA ★

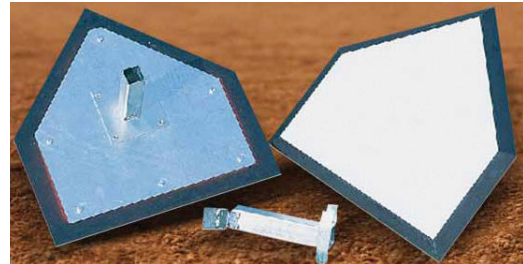
**MAJOR LEAGUE HOME PLATE**

- Beveled hard white rubber plate
- Includes anchor

**BBHPHWODBM** \$99<sup>22</sup> EA ★

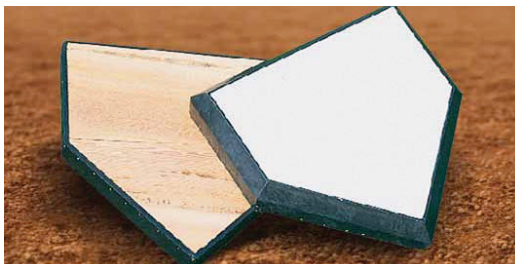
**WOOD-FILLED HOME PLATE**

- Full traditional solid wood filling for superior durability
- Beveled edges and sides reduce chance of cleats catching

**BBHPSAFE** \$99<sup>22</sup> EA ★

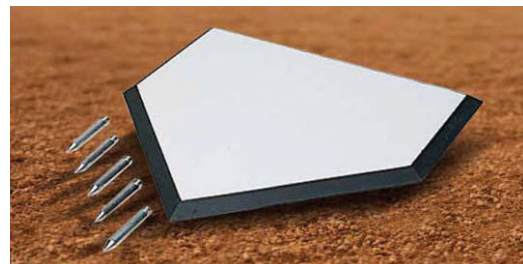
**RUBBER HOME PLATE**

- Solid white rubber with black beveled edges for safety
- Includes 5 spikes

**BBHPXXXXY** \$27<sup>22</sup> EA ★  
**BBHPSPIK** Replacement Spikes \$7<sup>22</sup> SET OF 5 ★

## MacGregor REC BASES



### HEAVY DUTY VINYL BASES

- Inverted sewn seams for extra durability and double-thick-top for long lasting wear
- Outer cover is 100% nylon-impregnated vinyl
- Polyfoam inner core for maximum shape retention
- Packed 3 bases per set with 6 spikes

<b>MCBASE5Y</b>	Official Size - 15" x 15"	\$54 <sup>22</sup> SET ★
<b>MCBASE35Y</b>	Youth Size - 14" x 14"	\$47 <sup>22</sup> SET ★
<b>BBSPIKES</b>	Replacement Spikes	\$14 <sup>22</sup> SET OF 6 ★

## MacGregor PROFESSIONAL BASES



### "Bolco" STYLE STRAPLESS BASES

- Made from rugged, bonded polyester padding that is tear-resistant and waterproof
- The base is easily bolted to its anchor plate
- Anchor plate contains metal sleeve for stability
- Base size - 15"L x 15"W x 3"H

<b>BBBASEOP</b>	Set - 3 Bases, 3 Stakes & 3 Plugs	\$197 <sup>22</sup> SET ★
<b>BBBASEBO</b>	Set - 3 Bases & 3 Stakes	\$184 <sup>22</sup> SET ★
<b>BBBASEOEA</b>	Single Base Only	\$69 <sup>22</sup> EA ★
<b>BBBOSPIK</b>	Base Ground Stakes	\$9 <sup>22</sup> SET ★



### MAJOR LEAGUE BASES

- Heavy gauge white rubber cover over a high density foam interior and all welded steel stanchion pan - no bolts to come loose.
- This base is designed to reduce sliding injuries, it is not a substitute for proper sliding
- Base size - 15" x 15" x 3"

<b>BBBASEPR</b>	Set of 3 w/Ground Anchors	\$179 <sup>22</sup> SET ★
<b>BBBASEPX</b>	Set (3)- w/o Ground Anchors	\$169 <sup>22</sup> SET ★
<b>BBBASEPP</b>	Set (3)- w/Ground Anchors, Plugs	\$199 <sup>22</sup> SET ★
<b>I170757</b>	Single Base Only	\$69 <sup>22</sup> EA ★

## MacGregor SAFETY BASES

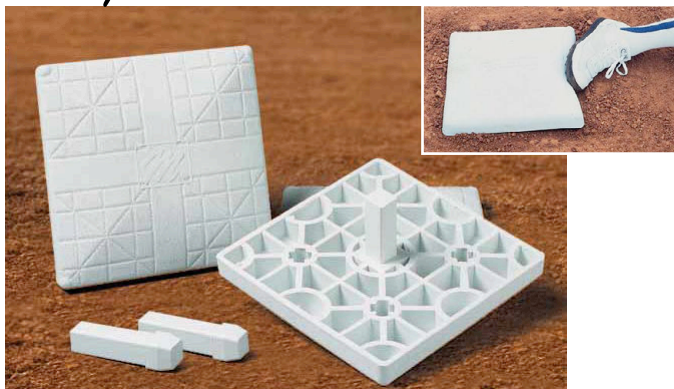

### SHOCK ABSORBING BASES

- This cushioned base is uniquely designed to help reduce injury
- The base gives at the right time to absorb the brunt of the slide
- Durable, one-piece molded rubber base with no metal parts - No rust!
- Removable white center post for easy storage and replacement.
- Does not include anchors

<b>BBBASRIC</b>	Complete Set without Anchors	\$199 <sup>22</sup> SET ★
<b>BBDFBSTN</b>	Replacement white center posts	\$19 <sup>22</sup> SET OF 3 ★



**NOTE: even bases designed to reduce sliding injuries are not a substitute for using proper sliding techniques.**

### MAGNETIC SUPER BASE

LITTLE LEAGUE® APPROVED.

**Reduce the risk of serious injury to sliding players with this unique base designed for all ages.** According to Rule 1.06 of the Little League® rule book, Beginning in 2008, it has become mandatory that all leagues utilize bases that disengage their anchor.

#### Features:

- Bases release when the magnetic attraction between the base and magnetic fixture are overcome by excessive force from a short slide.
- 3 different plate sizes bolt to the bottom of the base pan to adjust the holding strength of the base to the anchor.
- Base cover has a ribbed surface design to reduce the risk of slipping.

<b>BBMACMEG</b>	Complete Base - 15" x 15" x 3"	\$229 <sup>22</sup> EA ★
<b>BBMNFIXT</b>	Magnetic Base Fixture	\$179 <sup>22</sup> EA ★
<b>I185829</b>	Replacement Base Cover and Pan	\$86 <sup>22</sup> EA ★
<b>BBANCHOR</b>	Ground Anchors - 3/Set	\$29 <sup>22</sup> SET OF 3 ★

### MAGNETIC DOUBLE 1ST BASE

- Perfect addition for those who have magnetic type bases
- "White part" is attached to the magnetic stanchion conventionally leaving the safety orange base in foul territory
- "Orange part" is at ground level.

<b>I274127</b>	\$229 <sup>22</sup> EA ★
----------------	--------------------------

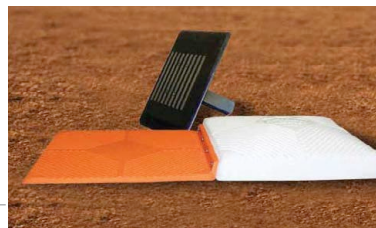

### BASE TRANSPORT CART

- Heavy-duty powder coated steel construction w/8" rubber tires
- Universal stems hold both 1" male and 1½" female style bases
- Includes a handy digout tool holder and rubber handle grip

3 Year Limited Warranty

<b>I265262</b>	\$244 <sup>22</sup> EA ★
----------------	--------------------------



## MacGregor *DOUBLE FIRST BASE*



### DOUBLE FIRST BASE

- One-piece molded rubber base
- No stitches to tear or rip
- Set includes 2 ground anchors for installation

**BDFBFSNR** 30"L x 15"W x 3"H \$154<sup>99</sup> EA ★

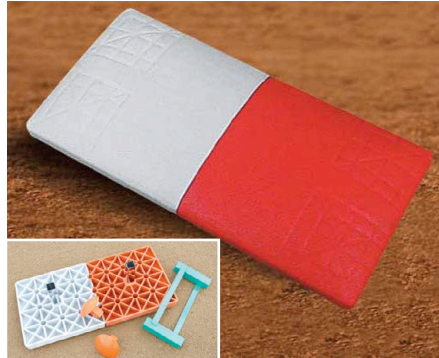

### PREMIUM DOUBLE FIRST BASE

- One piece molded rubber base with simulated quilted top and steel stanchions
- Size - 30"L x 15"W x 3"H
- Weight: 33 lbs.

**I235609** Set - Base, Anchor & Plugs \$237<sup>99</sup> EA ★  
**I235616** Repl. Anchor Only \$32<sup>99</sup> EA ★

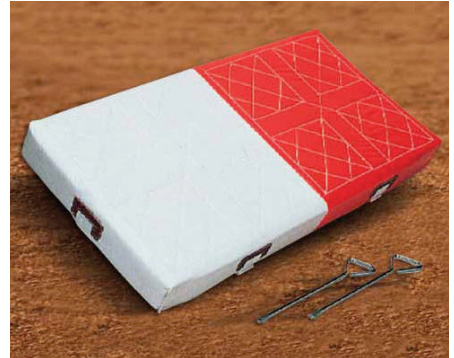

### RECREATIONAL DOUBLE FIRST BASE

- Designed to reduce the chances of collisions, spiking and injuries
- Heavy duty vinyl covering with soft rebounded foam filler
- Comes with 2 straps, 2 buckles and 2 spikes

**BDBLFB3** Size - 30"L x 15"W x 3"H \$49<sup>99</sup> EA ★

## MacGregor *INDOOR/P.E. BASES*



### THROW DOWN BASES

- 5 piece orange rubber throw down home plate, pitcher's plate and three base set
- Ideal for both indoor and outdoor use
- Made of washable and flexible rubber

**I235623** \$14<sup>99</sup> SET ★

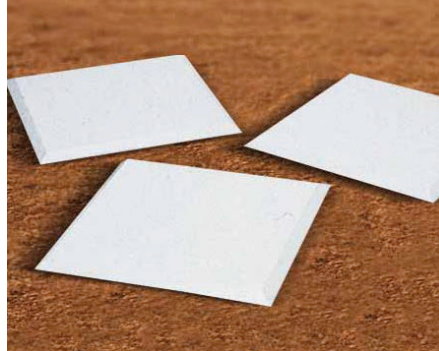

### RUBBER BASES

- Solid white, heavy duty molded
- Rubber throwdown bases with suction grip underside
- For use indoor and out

**BBSBBXXX** Set of 3 \$32<sup>99</sup> SET OF 3 ★  
**BBSBBEACY** Single Base \$13<sup>99</sup> EA ★

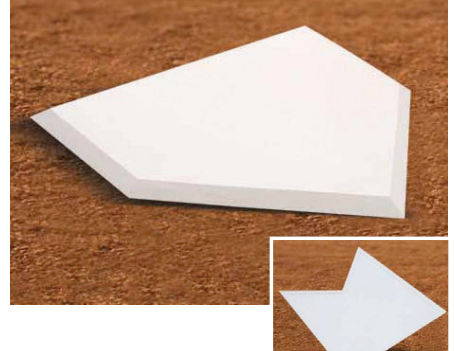

### RUBBER HOME PLATE

- Official size with suction grip underside for use indoor and out.
- Heavy duty white molded rubber
- No spikes

**BBSBHPXX** Home plate only \$18<sup>99</sup> EA ★  
**BBSBHPXX** Home Plate Extension (17" x 13") \$23<sup>99</sup> EA ★

## MacGregor *BASE ACCESSORIES*



### BIG LEAGUE BASE PLUGS

**BBBLPLUGPK** \$34<sup>99</sup> PACK

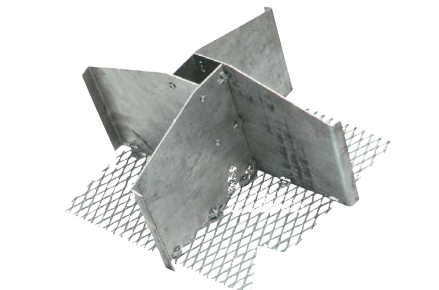

### HEAVY DUTY GROUND ANCHOR

**BBMNANCH** \$32<sup>99</sup> EA ★

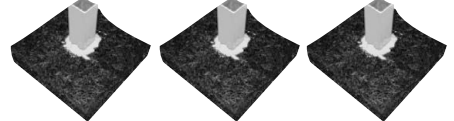

(photos shown prior to installation)

### BASE ANCHOR FOUNDATION

- A quick and easy way to set your base ground anchors without using concrete
- Just bury and tamp in place, you are ready to insert base and play
- Set includes rubber platform with built-in anchor

**I269895** Set of 3 \$129<sup>99</sup> SET  
**I269901** Single \$45<sup>99</sup> EA



### UNIVERSAL RUBBER ANCHOR PLUG

**BBRPLUGS** \$6<sup>99</sup> EA ★



### STANDARD GROUND ANCHORS

**BBANCHOR** \$29<sup>99</sup> SET OF 3 ★



### ANCHOR CLEAN OUT TOOL

**BBDIGOUT** \$12<sup>99</sup> EA ★



## schutt **HOLLYWOOD IMPACT KWIK RELEASE BASE**



### **HOLLYWOOD IMPACT QUICK RELEASE BASES**

- Patented Kwik-Release design compresses & disengages the base from its orange platform upon impact
- Fully compliant with Little League Rule 1.06
- Base platform stanchion fits standard ground anchor
- Female ground anchors and plugs are sold separately
- Bases are 15" x 15" x 3" and come in two resistance levels - youth or varsity.
- Youth bases take 20 lbs of force for base to "release"
- Varsity bases take 32 lbs of force for base to "release"

### **DOUBLE FIRST BASE DESIGN**

- Kwik-Release™ double first base disengages completely when enough force hits the base, but the orange base remains anchored to the ground
- Size - 15" x 15" x 2 1/4 - 2 3/4"
- Ground plugs and anchors sold separately

<b>1264791</b>	Kwik-Release: Dbl. 1st + 2 Youth Bases	<b>\$554<sup>22</sup></b> SET
<b>1264807</b>	Kwik-Release: Dbl. 1st + 2 Varsity Bases	<b>\$554<sup>22</sup></b> SET

<b>1274169</b>	Varsity Set of 3 Bases - Weight: 60 lbs	<b>\$399<sup>22</sup></b> SET
<b>1274176</b>	Varsity Individual Base - Weight: 20 lbs	<b>\$159<sup>22</sup></b> EA
<b>1274145</b>	Youth Set of 3 Bases - Weight: 60 lbs	<b>\$399<sup>22</sup></b> SET
<b>1274152</b>	Youth Individual Base - Weight: 20 lbs	<b>\$159<sup>22</sup></b> EA
<b>1236507</b>	Ground Anchors - 3/Set	<b>\$39<sup>22</sup></b> SET



## **SOFT TOUCH BASES**

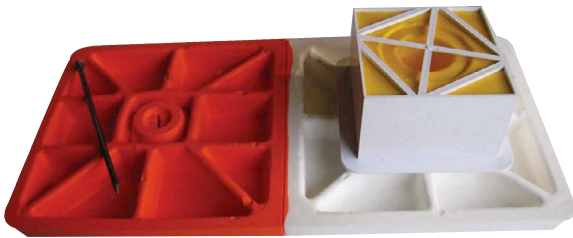

### **SOFT TOUCH™ DOUBLE FIRST BASE**

- White side anchored in ground mount, orange side anchored under the base with spikes.

<b>1236293</b>	<b>\$314<sup>22</sup></b> EA
----------------	------------------------------

Softtouch™ double first bases are not a release style base due to double ground anchors.



### **SOFT TOUCH™ PROGRESSIVE RELEASE BASE**

- Designed to flex and absorb energy as a player slides into the base
- "Pops out" on the impact of short, hard slides
- Molded 7" stem fits over the orange play-plug and inside the ground mount

<b>1. BBBASBRE</b>	Complete 15" Single Base	<b>\$129<sup>22</sup></b> EA
<b>2. BBBREMNT3</b>	Extra Ground Mounts - Set of 3	<b>\$54<sup>22</sup></b> SET
<b>3. 20026504</b>	Extra Tapered Plugs - Set of 3	<b>\$79<sup>22</sup></b> SET
<b>BBBASAYP</b>	Plugs (fills ground mounts) - set of 3	<b>\$84<sup>22</sup></b> SET



## **SOFT TOUCH CONVERTIBLE BASES**



### **SOFT TOUCH™ CONVERTIBLE DOUBLE 1ST BASE**

- Non-release style base
- Anchors into two ground anchors (not included)
- Male or female style

<b>1274138</b>	<b>\$319<sup>22</sup></b> EA
----------------	------------------------------



### **SOFT TOUCH™ CONVERTIBLE BASES**

- Designed to fit into your existing 1" male or 1-1/2" female ground anchors (ground anchors not included)
- Progressive release bases are designed to flex and absorb energy
- In the case of a short slide, the base is designed to pop free from its mount

<b>1236309</b>	Set of 3 - 15" Bases with Mounting Tees	<b>\$429<sup>22</sup></b> SET
----------------	---	-------------------------------



### **SYNTHETIC TURF BASE**

- Official size 15" x 15"
- Durable cut resistance polyurethane
- Bottom has a unique claw design that grabs the turf
- Does not require a mounting system

<b>1375580</b>	Set of 3	<b>\$554<sup>22</sup></b> EA
<b>1375581</b>	Single Base	<b>\$219<sup>22</sup></b> EA

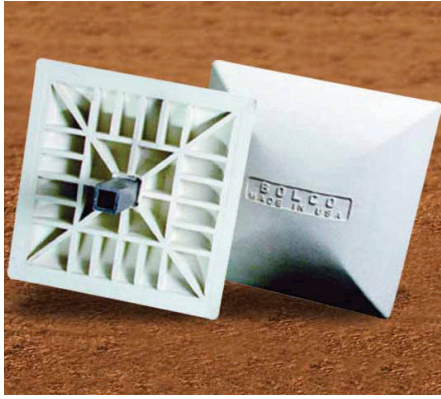
**ADAMS BOLCO BASES****Bolco 150-SB SAFETY BASE**

- One piece all rubber construction with universal aluminum stanchion.
- Tapered sides reduce the risk of injury
- Fits male or female ground anchors
- Ground anchors not included

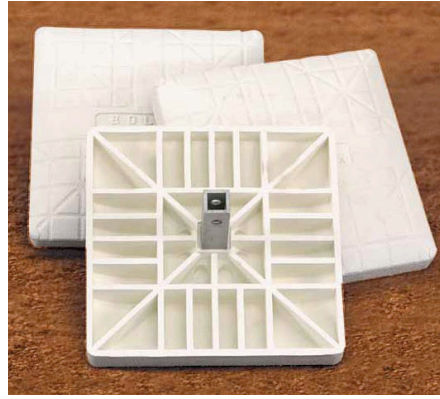
**1196528**\$299<sup>22</sup> EA**Bolco 175-MLB MAJOR LEAGUE BASE**

- One piece all rubber construction with universal aluminum stanchion
- Will fit male or female ground anchor
- Ground anchors not included

**1236408**

Size - 15" x 15" x 3"

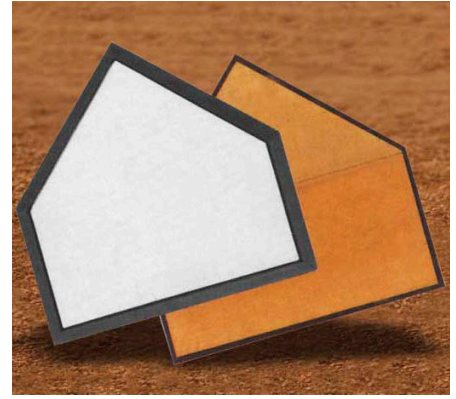
\$299<sup>22</sup> SET**Bolco 300-AS WOOD HOME PLATE**

- Quality vinyl cover over wood block filler
- Regulation size - 3" thick
- Weight: 29 lbs.

**1236415**\$109<sup>22</sup> EA**Bolco 100-ML MAJOR LEAGUE BASES**

- Bolt-on top plate design
- Official size 15" x 15" x 3"

**1236316**

Set of 3 Bases only

\$179<sup>22</sup> SET**1236325**

3 Bases, Top Plates &amp; Anchors

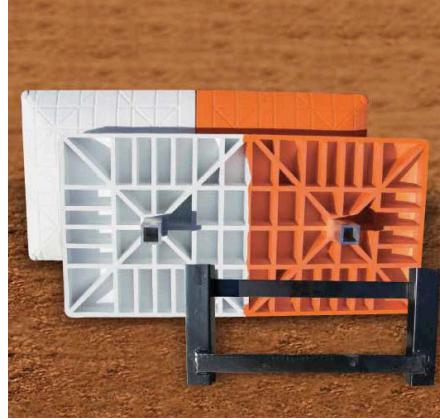
\$199<sup>22</sup> SET**Bolco DOUBLE FIRST BASE**

- One piece molded double base
- Will fit male or female ground anchor (not included)

**1196511**

Size - 15" x 30" x 3"

\$269<sup>22</sup> EA**1196535**

Double Ground Anchor

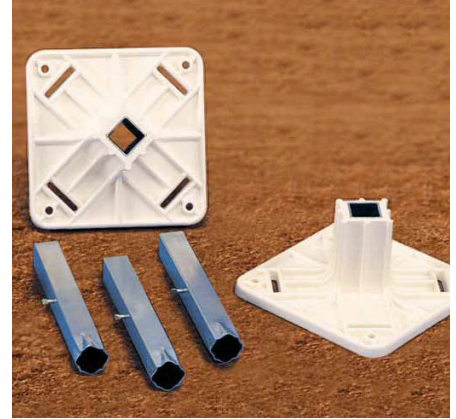
\$77<sup>22</sup> EA**BOLCO 205-BA BASE ANCHOR SET**

- Set contains 3 female plastic top plates and 3 male steel ground anchors to anchor 100-ML and 120-PRO bases.

**1236330**

Universal anchors

\$84<sup>22</sup> EA**BOLCO 4-WAY PITCHER'S RUBBER**

- Made of solid white rubber with PVC inner core
- Designed to be rotated to extend life

**1236361**

Official Size - 6" x 24"

\$114<sup>22</sup> EA**1236378**

Youth Size - 4" x 18"

\$89<sup>22</sup> EA**BOLCO STEP DOWN PITCHER'S RUBBER**

- Step down pitcher's plate with traditional solid wood core and molded rubber cover
- Front extension prevents holes in front of plate and reduces mound maintenance
- No stakes or spikes required

**1236385**

Official Size - 6" x 24"

\$89<sup>22</sup> EA**1236392**

Youth Size - 4" x 18"

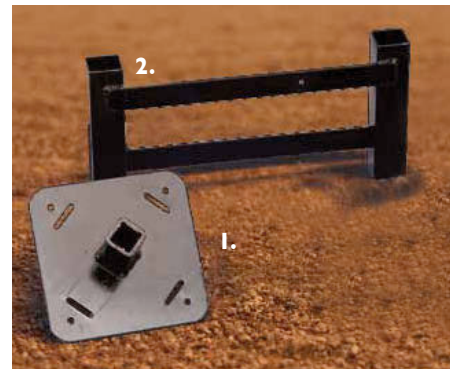
\$79<sup>22</sup> EA**1. ANCHOR TOP PLATE**

- One female plastic top plate that fits over male anchor stakes

**1236347**

Bolco Anchor Top Plate

\$13<sup>22</sup> EA**2. DOUBLE GROUND ANCHOR**

- All steel - for double 1st base or pitcher's rubber

**1196535**

Double Ground Anchor

\$77<sup>22</sup> EA

## schutt **HOLLYWOOD BASES**



### HOLLYWOOD® SAF-T-SLIDER™ BASES

- Unique beveled corners sit flush with the ground
- Durable, heavy-gauge rubber construction
- Ideal for youth and recreational softball play
- Ground anchors sold separately

**1036992**

 \$309<sup>ZZ</sup> SET

### HOLLYWOOD IMPACT BASES

- Constructed of high quality rubber with honeycomb design for flexibility and durability
- Base compresses as runner slides into it
- Replaceable steel stanchion fits the hollywood ground anchor (sold separately)

**1236439**

Size - 15" x 15" x 2"

**\$339<sup>ZZ</sup> SET**

### HOLLYWOOD 4-WAY PITCHER'S RUBBER

- The most stable, rugged, 4-sided pitching rubber available
- Interior aluminum tube for maximum longevity when filled with dirt or concrete

**1236460**

Official Size - 6" x 24"

**\$174<sup>ZZ</sup> EA**

### HOLLYWOOD IMPACT DOUBLE FIRST BASE

- Constructed of high quality rubber with honeycomb design
- Base compresses as runner slides into it.
- Anchors and base plugs sold separately

**1236453**

Base only

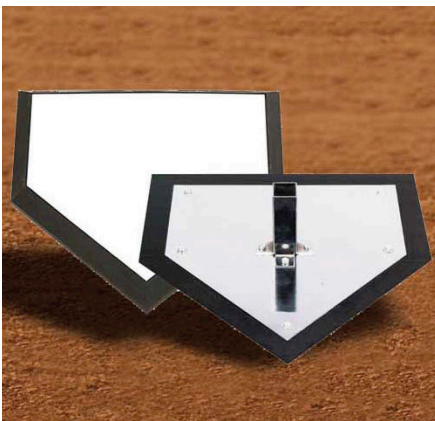
**\$229<sup>ZZ</sup> EA**

### HOLLYWOOD HOME PLATE

- Stanchion mounted professional homeplate

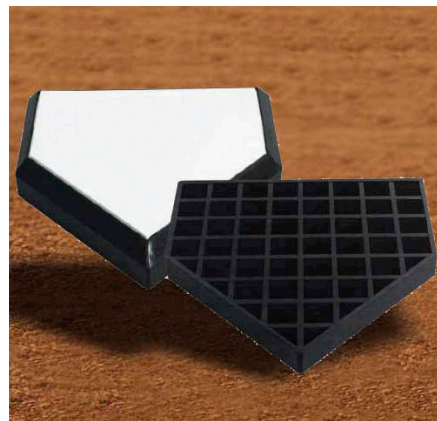
**1236484**
**\$149<sup>ZZ</sup> EA**

### HOLLYWOOD BURY-ALL HOME PLATE

- High-durability, all rubber waffle design
- No corners or edges to catch spikes
- Non-skid rubber surface, waterproof

**1236477**
**\$169<sup>ZZ</sup> EA**

### ORIGINAL HOLLYWOOD BASES®

**THE ORIGINAL JACK CORBETT® BASES USED BY MAJOR LEAGUE BASEBALL SINCE 1939**

- Major league base designed to provide greater strength and durability under constant usage.
- Tapered lip ground hugging feature reduces possibility of edge turn-up due to impact.
- Natural rubber cover with steel stanchion.
- Requires Hollywood ground anchors.
- Anchors and base plugs sold separately

**1036930**

Size - 15" x 15" x 3"

**\$269<sup>ZZ</sup> SET**

### ACCESSORIES

1. <b>1236507</b>	Ground Anchors - 3/Set	<b>\$39<sup>ZZ</sup> SET</b>
2. <b>BBRPLUGS</b>	Base Plugs	<b>\$6<sup>ZZ</sup> EA ★</b>
3. <b>1236491</b>	Anchor	<b>\$49<sup>ZZ</sup> EA</b>
4. <b>BBDIGOUT</b>	Dig-Out Tool	<b>\$12<sup>ZZ</sup> EA ★</b>

# BASEBALL/SOFTBALL

The official supplier to  
Major League Baseball

## PRACTICE MOUNDS

**PITCHER'S PLATFORM**

- Protects field during batting practice
- Rugged aluminum frame
- Attached tires for easy portability
- Non-marking pads included for indoor use
- Mound height adjusts from 10" to 6"
- No flat tires

**BSPROPLAT** 7'L x 3'W x 10' 6" H \$999<sup>22</sup> EA ★ **S&H**



Includes free measuring tape!

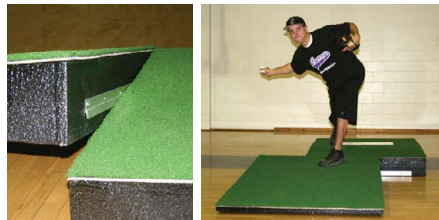

Green Turf Red Clay Turf

**PROFESSIONAL 2-PC MOUND WITH TURF**

- 2-piece mound w/turf made with high density foam and protected with Rubber Armor Technology
- Skid proof, non-slip bottom - won't damage gym floors
- Used by NCAA Division I programs

**MP2031** Size - 10"H x 4"W x 9'L \$1,299<sup>22</sup> EA **S&H**

**PROPER PITCH YOUTH TRAINING MOUND**

- High density foam core with heavy duty turf top
- Great for working on mechanics indoors or out.

**1162981** Size - 4"H x 42"W x 42"L \$489<sup>22</sup> EA

**PORTABLE INDOOR PITCHING MOUND**

- Full body construction that is composed of polyethylene foams with a polyurethane elastomer covering
- Two-piece design locks together
- Each section weighs less than 40 lbs.
- Cushioned landing area reduces knee and ankle strain

**BBPIPMXX** 10"H x 4"W x 8.5'L \$1,299<sup>22</sup> EA **S&H**



Includes free measuring tape!

**PRACTICE MOUND WITH TURF**

- Heavy duty polystyrene that is completely encased in a thick rubber coating for durability
- Rubber coating is skid resistant and will not damage gym floors
- Spike proof turf top will accommodate all cleats including metal

**1237146** Size - 10"H x 5"W x 9'L \$1,399<sup>22</sup> EA **S&H**

**1237153** Size - 10"H x 4"W x 9'L \$1,299<sup>22</sup> EA **S&H**

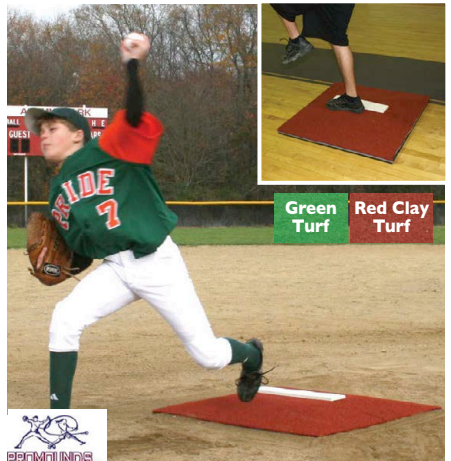

Green Turf Red Clay Turf

**TRAINING MOUND**

- Made of high density foam and protected with Rubber Armor Technology
- Used at all levels of play for indoor drills
- Great for backyard training, camp and clinics
- Portable, lightweight, durable
- Please specify: green or red clay turf

**MP3001** Size - 4"H x 36"W x 36"L \$399<sup>22</sup> EA

## SOFTBALL PITCHER'S MATS

**JENNIE FINCH PITCHING MAT WITH POWER LINE**

- Pitching mats made from spike-resistant/turf
- 2" wide inlaid white line for more precise training
- Regulation pitching rubber attached
- Comes with a convenient carrying case
- Non-skid bottom for gym floors

**1266016** 3'W x 10' L

\$259<sup>22</sup> EA

**JENNIE FINCH PITCHER'S LANE PRO**

- Regulation pitching rubber attached and made from spike-resistant artificial turf with a no slip backing.
- Helps pitchers comply with NCAA regulations (Rule 2.19) that restricts pitchers from pitching outside the 24' pitching rubber.
- Comes with a free carrying case.

**1291360** Size - 3'W x 10'L \$289<sup>22</sup> EA

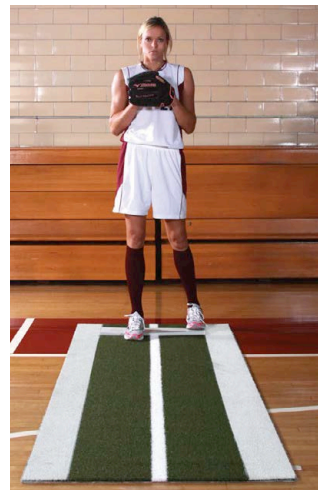

## PRACTICE MOUNDS

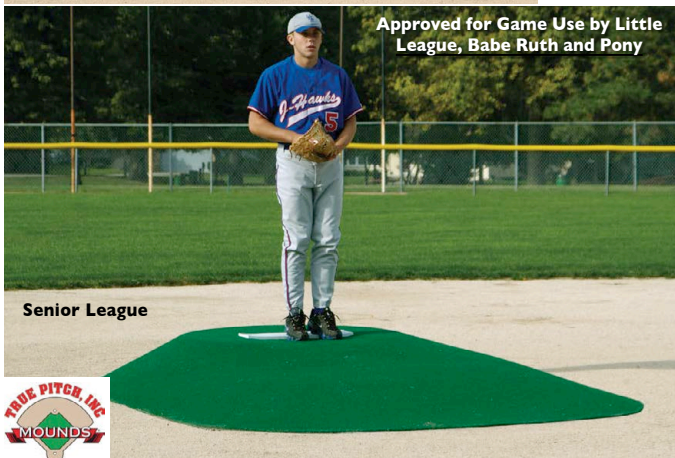
**Pony League**
**Little League**

**Senior League**

Approved for Game Use by Little League, Babe Ruth and Pony



### TRUEPITCH® PORTABLE GAME MOUND

- Lifetime fiberglass shell covered with Astroturf®.
- Approved by Little League for game use
- For plastic and rubber cleats only
- Padded landing area for comfort and safety
- Tapered edges for a smooth mound to field transition
- Available in green or clay colored turf. Please specify

BBPORTRE	Senior - 10"H x 10"W x 12'6"L	\$4,299 <sup>22</sup> EA	
BBPORTPB	Pony League - 8"H x 8"W x 10'L	\$3,499 <sup>22</sup> EA	
BBPORTMD	Little League - 6"H x 6'10"W x 9'2"L	\$2,899 <sup>22</sup> EA	



## Major League Mound

Clay Green

### MAJOR LEAGUE GAME MOUNDS

- Made of high density foam & protected with Rubber Armor Technology.
- Converts your softball field into a baseball field
- Official Little League height specifications
- Great for indoor and outdoor use
- Lightweight, durable, portable
- Length allows pitching from the rubber and land on mound
- Available in either green or red clay turf

MP3003	6"H x 60"W x 99"L	\$1,299 <sup>22</sup> EA	
MP3002	6"H x 60"W x 72"L	\$974 <sup>22</sup> EA	



### PROPER PITCH GAME MOUNDS

- Perfect for sharing fields for different age groups
- Strong and lightweight polystyrene construction
- Turf cover
- Padded landing area
- Non-slip backing

5417004	Standard - 10"H x 8"W x 11'6"L	\$3,149 <sup>22</sup> EA	
5417001	Junior - 6"H x 5'4"W x 9'L	\$1,874 <sup>22</sup> EA	
5417000	Youth - 6"H x 4"W x 9'L	\$999 <sup>22</sup> EA	

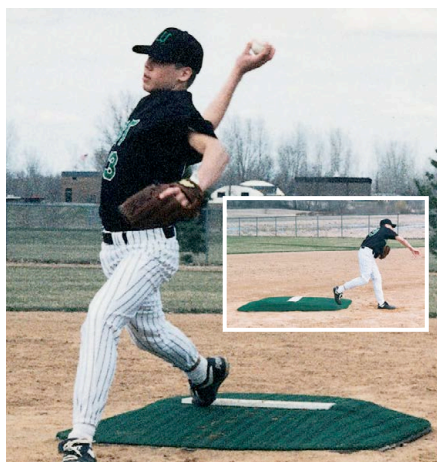

### YOUTH LEAGUE PITCHING MOUND

- Turn any softball field into a baseball field
- 6" pitching mound will feel comfortable to any pitcher 5' or taller
- Manufactured with resilient polyethylene foams
- Simulated rubber covering
- Fully turfed with regulation pitching rubber

1237139	Youth - 6"H x 48"W x 72"L	\$1,274 <sup>22</sup> EA	
---------	---------------------------	--------------------------	--



### ACCUPITCH GAME MOUNDS

Green Turf Red Clay Turf

- Spikeproof Astro turf covered mounds convert your field from baseball to softball in minutes
- Tapered edges allow you to rake your infield material over the edges to create a smooth transition
- Please specify green or clay color turf

1273953	Little League - 6"H x 64"W x 9'L	\$1,799 <sup>22</sup> EA	
1273960	Pony League - 8"H x 8"W x 10'L	\$2,499 <sup>22</sup> EA	
1273977	Official Size - 10"H x 8"W x 11'-6"L	\$3,099 <sup>22</sup> EA	



### STALKER SPORT 2 RADAR GUN

- Simultaneously displays release and plate speeds
- Displays speed in either units or tenths
- Concurrent radar and stopwatch operation
- Uses AA NiMh rechargeable batteries
- Rugged polymer case
- In-gun-battery wall charger is included

I274813 Complete Unit \$889<sup>22</sup> EA



### VELOCITY™ SPEED GUN

- Ideal for youth through high school programs.
- Using digital signal processing, it measures the velocity of a baseball or softball up to 110 mph from a distance of 100 feet away
- Heavy-duty construction, large LCD readout, and easy-to-use instructions
- Uses 2 "C" batteries (not included)

I087932 \$189<sup>22</sup> EA



### BALL COACH

- Specifically designed to measure the fastest speed of a ball in flight
- Easy trigger capabilities eliminate any timing requirements
- Measures from 25 mph to 130 mph and is accurate to within +/- 1 mph
- Includes soft-shell belt holster case, wrist strap, 2 AAA alkaline batteries

I38551I \$299<sup>22</sup> EA



### CORDLESS RADAR GUN

- Operates on two rechargeable Black & Decker batteries
  - Advanced DSP technology allows faster and more accurate readings release point
  - Operates in manual trigger mode and automatic mode
- 2 Year Limited Warranty**

I235982 \$1,499<sup>22</sup> EA



### ROSIN BAG

- High quality rosin in resealable polybag for long-lasting use.



5A162628

\$6<sup>22</sup> EA



**NEW!**

### COACH DAVE'S ALL SPORT 500

- Displays total pitches thrown
- Displays total balls and strikes
- Tracks two pitchers at the same time
- Can be used in any sport to track attempts and % made

I242355

\$39<sup>22</sup> EA ★



### TALLY COUNTER

- Hand held model
- Counts up to 9999

MSHTALLY \$9<sup>22</sup> EA ★



### HOME & ROAD PITCH COUNTER

- Dual pitch counter allows coaches to track two pitchers at once
- Sleek design fits ergonomically in hand

I264067 Color: Black only \$16<sup>22</sup> EA



### SKYSCAN™ P5 LIGHTNING DETECTOR

- Detects lightning as far as 40 miles away and accurately ranges its approach by both an audible tone and by four LED's which are ranged in miles (0-3, 3-8, 8-20, 20-40)
- Requires (2) 9V batteries (not included)
- AC adapter not included
- Rugged weather resistant case

SKYSCANX  
20026501  
20026502

Portable Unit  
Soft Carry Case  
110V AC Adapter



\$299<sup>22</sup> EA  
\$39<sup>22</sup> EA  
\$34<sup>22</sup> EA



### DOUBLE SHOULDER

- Pleated fabric design enables the ice bag to contour with the body
- Compression wrap
- Comes with two 11" refillable icebags
- Durable mesh carry bag included



I385292

Fits L or R

\$79<sup>22</sup> EA

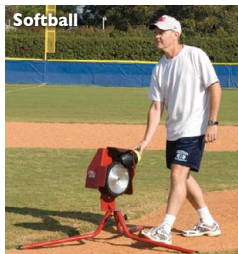

### BULLDOG BB/SB PITCHING MACHINE

- Speed: 30-60 mph
- Throws baseballs, 11" and 12" softballs
- Runs on 110 volt AC or generator 1/4 HP D.C. motor
- Durable urethane wheel eliminates air pressure issues
- Heavy duty legs are convertible for baseball or softball

<b>BBDGIXX</b>	Complete Unit	\$749 <sup>22</sup> EA ★
<b>BBDGIWL</b>	Replacement Wheel	\$219 <sup>22</sup> EA ★

### BULLDOG ELITE 2 WHEEL PITCHING MACHINES

- Throws curves, fastballs, sliders, sinkers and knuckleball
- Can throw pop-ups as well as grounders
- Pitch speed between 30 - 102 mph
- Urethane wheels eliminate air pressure problems
- Attached wheels for easy transport
- Best suited to throw dimple balls
- Weight: 95 lbs.

<b>BULLELITEBB</b>	Baseball Model	\$1,699 <sup>22</sup> EA ★	
<b>BULLELITESB</b>	Softball Version	\$1,699 <sup>22</sup> EA ★	
<b>ZPMLEGSB</b>	BB to SB conversion kit - Includes legs & chute	\$144 <sup>22</sup> SET ★	
<b>ZPMLEGBB</b>	SB to BB conversion kit - Includes legs & chute	\$144 <sup>22</sup> SET ★	



Holds 500 Baseballs!

### DELUXE IRON MIKE (MP5)

- Ball rack capacity: 38 baseballs or 28 softballs
- Easily converted from baseball to softball
- Four wheel transport for quick, easy moving
- Low voltage remote control with 80' cord
- Electrically powered by 115 volt AC motor
- Lockable arm guard cover
- Speed up to 85 mph
- Please choose either a softball or baseball pitching arm

1237214	Complete Unit	\$3,499 <sup>22</sup> EA	
1273946	Weather Cover (MP-5)	\$199 <sup>22</sup> EA	

### DELUXE IRON MIKE w/HOPPER (MP6)

- Heavy duty hand and arm system simulates wind-up and delivery
- Speed from 25 - 85 mph
- Operates on 110V power with 80' low voltage remote switch
- Includes a hopper for 600 baseballs
- Transport wheels not included
- Weight: 600 lbs

1273939	Complete Unit	\$4,099 <sup>22</sup> EA	
1273984	Weather Cover (MP-4 & MP-6)	\$259 <sup>22</sup> EA	



### DIMPLED MACHINE BALLS

- Soft, durable yellow polyurethane
- Designed safe for aluminum bats

<b>MCDBBYEL</b>	9" Baseball	\$28 <sup>22</sup> DZN ★
<b>BBDSBALL</b>	12" Softball	\$34 <sup>22</sup> DZN ★



### ULTIMATE® PITCHING MACHINE

- Versatile non-electric pitching machine
- Throws baseballs, softballs and safety balls
- Speeds up to 45 MPH
- Quickly and easily adjust the pitch speed and location
- Little League® approved
- Weight: 15 lbs



<b>200160111</b>	Complete Unit	\$269 <sup>22</sup> EA
<b>1058888</b>	Replacement Spring	\$24 <sup>22</sup> EA

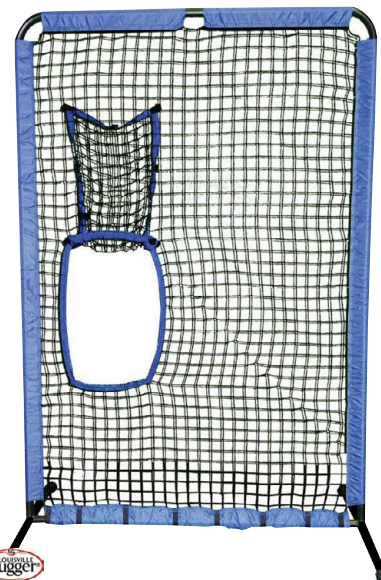

### PORTABLE PITCHING SCREEN

- For use with Ultimate Pitching Machine
- Hole cut-out: 10"W x 18"H

<b>560115</b>	Size - 48"W x 72"H x 36"D	\$124 <sup>22</sup> EA
---------------	---------------------------	------------------------

## FLAT SEAM



**MARK1**

**OFFICIAL LEAGUE**

- Leather cover
- Cork and rubber core
- Yarn windings
- Flat seams

**BSOLBFS**

Flat Seam

\$32<sup>22</sup> DZN ★



**Baden**  
PERSON FOR A BETTER GAME

**3B Pro CLF**

- Pro grade premium leather cover
- Pro grade gray wool windings
- Cushioned cork center
- Flat seam

1385306

Flat Seam

\$79<sup>22</sup> DZN



**Baden**  
PERSON FOR A BETTER GAME

**2BBGF**

- Premium leather cover
- Cushioned cork center
- Premium blend windings
- Flat seam

1385307

Flat Seam

\$49<sup>22</sup> DZN



**Wilson**

**A1010 Pro**

- Grade A full grain leather
- Cushioned cork
- Premium gray wool windings
- Flat seam

1385405

Flat Seam

\$79<sup>22</sup> DZN

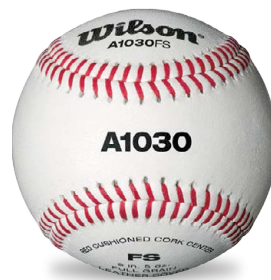

**Wilson**

**A1030**

- Grade C/D full grain leather
- Red cushioned cork
- Gray wool windings
- Flat seam

1385406

Flat Seam

\$44<sup>22</sup> DZN



**Diamond**

**DI Pro - Flat Seam**

- Full grain leather cover
- Cushioned cork center
- Grey wool windings
- Flat seam

1385517

Flat Seam

\$84<sup>22</sup> DZN

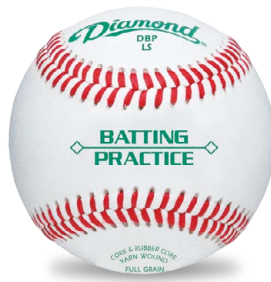

**Diamond**

**DBP - PRACTICE**

- Full grain leather cover
- Cork and rubber core
- Yarn windings
- Flat seam

1385518

Flat Seam

\$49<sup>22</sup> DZN



**Rawlings**

**FSRI NCAA**

- Official ball of the NCAA
- Full grain leather cover
- Cushioned cork center
- Wool windings
- Flat seam

1385512

Flat Seam

\$94<sup>22</sup> DZN



**Rawlings**

**FSRI00 NAIA**

- Official ball of the NAIA
- Full grain leather cover
- Cushioned cork center
- Wool windings
- Flat seam

1385513

Flat Seam

\$94<sup>22</sup> DZN



**Rawlings**

**FSRI00**

- Full grain leather cover
- Cushioned cork center
- Flat seams

1385514

Flat Seam

\$94<sup>22</sup> DZN



**Rawlings**

**FSOLBX - PRACTICE**

- Practice Ball
- Leather cover
- Flat seams

1385515

Flat Seam

\$56<sup>22</sup> DZN



## HIGH SCHOOL/COLLEGE

BASEBALL/SOFTBALL



**MacGregor**  
**#79 PRACTICE**

- Cork and rubber core
- Raised seams

**MCB79PXX** Leather \$37<sup>22</sup> DZN ★  
**MCB79PYX** Synthetic \$21<sup>22</sup> DZN ★



**MacGregor** **NFHS**  
**#97 MAJOR LEAGUE**

- Cushioned cork center
- Gray/white/gray yarn windings
- A grade leather cover
- Raised seams

**MCB97MLH** w/NFHS Logo \$56<sup>22</sup> DZN ★  
**MCB97MLX** w/o NFHS Logo \$54<sup>22</sup> DZN ★



**MacGregor**  
**#97 PROFESSIONAL LEAGUE**

- Cushioned cork center
- Grey english wool windings
- A grade leather cover
- Raised seams

**MCB97PRO** \$54<sup>22</sup> DZN ★

**MARK I**  
**OFFICIAL LEAGUE**

- Leather cover
- Cork and rubber core
- Yarn windings
- Raised seams

**BSOLB** \$32<sup>22</sup> DZN ★



**MacGregor**  
**#87SP OFFICIAL LEAGUE**

- Cork and rubber center
- Split leather cover
- Raised seams

**MCB87SPX** \$32<sup>22</sup> DZN ★



**MacGregor**  
**#87OL OFFICIAL LEAGUE**

- Cushioned cork center
- Select wool windings
- Leather cover
- Raised seams

**MCB87OLX** \$43<sup>22</sup> DZN ★



**Wilson**  
**A1030B HIGH SCHOOL**

- Cushioned cork center
- Grey wool windings
- Grade C leather cover
- Raised seams

**5A1030B** \$49<sup>22</sup> DZN



**Baden** **NFHS**  
**3B-NFHS**

- NFHS approved baseball
- Premium leather cover
- Performance seams
- Raised windings

**1362015** \$69<sup>22</sup> DZN



**Wilson**  
**A1010 PRO - NFHS**

- Grade A full grain leather
- Premium gray wool windings
- Raised seams
- Ballistic cushioned cork center

**CCA1010BPRO** \$89<sup>22</sup> DZN



**Diamond**  
**DBP PRACTICE**

- Cork and rubber pill
- A-Grade gray wool winding
- Premium leather cover
- Diamond Seam™

**1159042** \$49<sup>22</sup> DZN



**Diamond**  
**DI-PRO**

- Cushioned cork center
- A-1 grade wool winding
- Premium leather cover
- Diamond Seam™

**1187359** \$84<sup>22</sup> DZN



**Diamond** **NFHS**  
**DOLI**

- Cork & rubber core
- Select wool blend windings
- Full grain leather cover
- Diamond seams

**BSDOLI** \$47<sup>22</sup> DZN



**Rawlings** **NFHS**  
**R100NF**

- Cushioned cork center
- Full grain leather cover
- Superstitch® raised seams
- NFHS Approved

**RR100NF** \$87<sup>22</sup> DZN



**Wilson** **NFHS**  
**A1010 H.S. SST**

- NFHS approved
- Red cushion cork center
- Premium wool windings
- Grade A leather cover

**1371531** \$77<sup>22</sup> DZN



**Rawlings** **NFHS**  
**RNFC**

- Cushioned cork center
- Leather cover
- Raised seams
- NFHS approved

**1300543** \$59<sup>22</sup> DZN



**Baden** **NFHS**  
**3B-PPRO PERFECTION**

- NFHS approved
- Premium leather cover
- Cushioned cork center
- Raised seams

**1300307** \$79<sup>22</sup> DZN



**Diamond** **NFHS**  
**DI-PRO NFHS**

- Cushioned cork center
- A-1 Grade wool winding
- Premium leather cover
- Diamond Seam™

**1187366** \$84<sup>22</sup> DZN



**Diamond** **NFHS**  
**DOL-A OFFICIAL LEAGUE**

- Cushioned cork center
- A-grade grey wool winding
- Premium leather cover
- Diamond Seam™

**1159028** \$59<sup>22</sup> DZN



**Diamond** **NFHS**  
**DI-NFHS**

- Cushioned cork center
- A-grade grey wool winding
- Premium leather cover
- Diamond seam™

**1187373** \$74<sup>22</sup> DZN

**PONY**

**MacGregor**  
**#75 OFFICIAL PONY®**

- Cushioned cork center
- Select wool windings
- Leather cover
- Raised seams

**MCB75CXX** \$43<sup>22</sup> DZN ★

**MacGregor**  
**#75CY YOUTH PONY®**

- Cork and rubber center
- Select wool windings
- Leather cover
- Raised seams

**MCB75CYX** \$39<sup>22</sup> DZN ★

**Diamond**  
**DPL PONY LEAGUE**

- Cushioned cork center
- A-Grade gray wool winding
- Premium leather cover
- Tournament grade

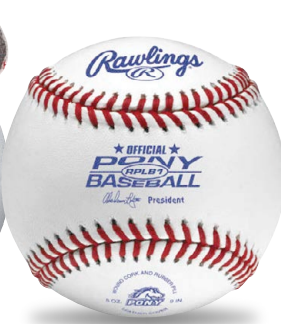
**I159059** \$62<sup>22</sup> DZN

**Rawlings**  
**RPLBI PONY LEAGUE**

- Cork and rubber center
- Full grain leather cover
- Raised seams

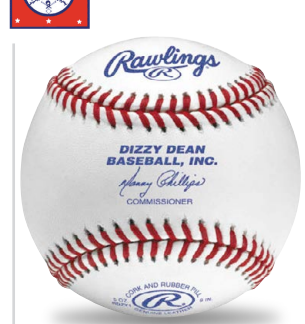
**I420274** \$49<sup>22</sup> DZN

**DIZZY**

**Rawlings**  
**RDZYI DIZZY DEAN**

- Cork and rubber center
- Full grain leather cover
- Raised seams

**I419932** \$49<sup>22</sup> DZN

**DIXIE**

**MacGregor**  
**#78 DIXIE® BOYS & MAJORS**

- Cushioned cork center
- Select wool windings
- Leather cover
- Raised seams

**MCB78CXX** \$43<sup>22</sup> DZN ★

**MacGregor**  
**#72 DIXIE® YOUTH**

- Cork and rubber center
- Select wool windings
- Leather cover
- Raised seams

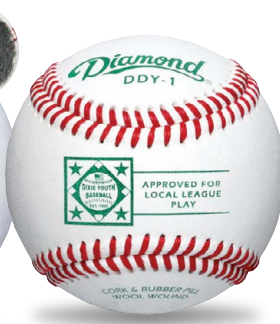
**MCB72CXX** \$39<sup>22</sup> DZN ★

**Diamond**  
**DDY-1 DIXIE YOUTH**

- Cork and rubber pill
- Select wool blend winding
- Premium leather cover
- Diamond Seam™

**I159141** \$47<sup>22</sup> DZN

**CAL RIPKEN**

**MacGregor**  
**#74 CAL RIPKEN®**

- Cork and rubber center
- Select wool windings
- Leather cover
- Raised seams

**MCB74CAL** \$39<sup>22</sup> DZN ★

**Rawlings**  
**RCALI CAL RIPKEN®**

- Cork and rubber center
- Full grain leather cover
- Raised seams

**I055795** \$49<sup>22</sup> DZN

**BABE RUTH**

**MacGregor**  
**#74 OFFICIAL BABE RUTH®**

- Cushioned cork center
- Select wool windings
- Leather cover
- Raised seams

**MCB74CXX** \$43<sup>22</sup> DZN ★

**Diamond**  
**DBR-1 BABE RUTH**

- Cork and rubber pill
- Select wool blend winding
- Premium leather cover
- Competition grade baseball

**I159080** \$49<sup>22</sup> DZN

**Rawlings**  
**RBRO(I) BABE RUTH®**

- Cushioned cork center
- Leather cover
- Raised seams

**I055771** RBRO \$67<sup>22</sup> DZN  
**I055788** RBROI \$47<sup>22</sup> DZN

**USSSA**

**Rawlings**  
**ROLBI - USSSA**

- Cork and rubber center
- Full grain leather cover
- Raised seams
- USSSA approved

**I055801** ROLBI \$49<sup>22</sup> DZN  
**I055818** ROLBIX \$42<sup>22</sup> DZN

**Wilson**  
**A1030 USSSA**

- Cushioned cork center
- Gray wool yarn
- Grade C leather cover
- Raised seam

**I195279** \$47<sup>22</sup> DZN



*Little League.*

© 2015 Little League Baseball, Incorporated, All Rights Reserved.



**SPALDING  
OFFICIAL**

- Cushioned cork center
- Gray wool windings
- Full grain leather cover
- Raised seams

**1323757** \$54<sup>99</sup> DZN



**Rawlings  
RLLB(1)**

- Full grain leather cover
- Raised seams
- RS-T stamped

**1055740** Cushioned Cork \$67<sup>99</sup> DZN  
**1055757** Cork & Rubber \$49<sup>99</sup> DZN



**MacGregor  
#76C1**

- Cork and rubber center
- Select wool windings
- Raised seams

**MCB76C1X** Leather Cover \$41<sup>99</sup> DZN ★

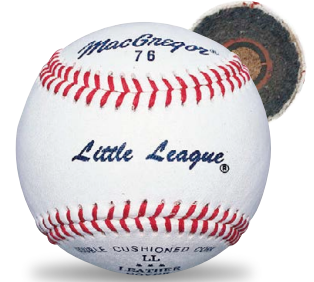

**MacGregor  
#76C**

- Cushioned cork center
- Select wool windings
- C Grade Leather cover
- Raised seams / RS-T stamped

**MCB76CXX** C Grade Cover \$43<sup>99</sup> DZN ★



**Diamond  
DLL-1**

- Little League competition grade baseball
- Cork and rubber pill w/ select wool windings
- Premium leather cover
- Raised seams

**1159103** \$48<sup>99</sup> DZN



**Wilson  
AI074BSST**

- Red cushion cork center
- Grey wool windings
- Raised seams

**5AI074BSST** B Grade Cover \$63<sup>99</sup> DZN  
**5AI074BLLI** C Grade Cover \$52<sup>99</sup> DZN



*Sr. Little League.*

© 2015 Little League Baseball, Incorporated, All Rights Reserved.



**Diamond  
DSLL-1 SENIOR LEAGUE**

- Cork and rubber pill center
- Select wool blend winding
- Premium leather cover
- Diamond Seam™

**1159127** \$49<sup>99</sup> DZN



**Rawlings  
RSSL SENIOR LEAGUE**

- Cushioned cork center
- Full grain leather cover
- Raised seams
- RS-T stamped

**1055764** \$67<sup>99</sup> DZN

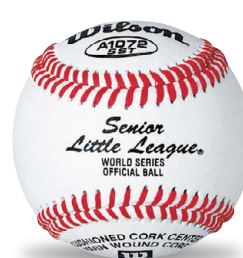

**Wilson  
AI072BSST SR. LITTLE LEAGUE®**

- Features Super Seam Technology™
- Cushioned cork center
- RS-T Stamped

**1015683** \$69<sup>99</sup> DZN



**MacGregor  
#73C SENIOR LEAGUE**

- Cushioned cork center
- Select wool windings
- Leather cover
- Raised seams

**MCB73CXX** \$46<sup>99</sup> DZN ★

**TEE BALL**



**MacGregor  
SAFE/SOFT BASEBALL**

**3 LEVELS OF SAFETY FOR ALL AGES**

- Meets NOCSAE standard
- Leather cover with patented Tri-Flex safety core
- Raised seams

**MCB55V01** Level 1 Ages 5 - 7 \$47<sup>99</sup> DZN ★  
**MCB55V05** Level 5 Ages 8-12 \$47<sup>99</sup> DZN ★  
**MCB55V10** Level 10 Ages 12+ \$47<sup>99</sup> DZN ★



**WORTH  
R.I.F. SAFETY BASEBALLS**

- Leather cover
- Meets NOCSAE standards
- Little League® approved

**BLLRIF9** Level 5 - Ages 8-12 \$67<sup>99</sup> DZN

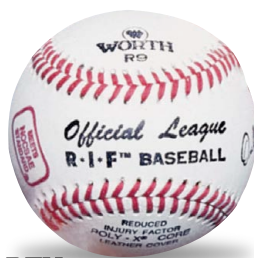

**SAFETY**

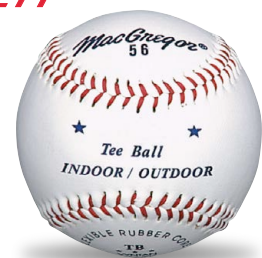

**MacGregor  
#56 OFFICIAL TEE BALL**

- "Vyntan" synthetic leather cover
- Low bounce rubber core
- Double-stitched seams
- Ideal for tee ball & indoor or outdoor training

**MCB56TBX** \$31<sup>99</sup> DZN ★

MacGregor **FAST PITCH SOFTBALLS**

MacGregor

**LITTLE LEAGUE® APPROVED**

- League approved / stamped
- COR. 47/375 lb max comp.
- Poly graphite center
- Leather cover

MCSBI1LLY	11"	\$58 <sup>99</sup> DZN ★
MCSBI2LLY	12"	\$62 <sup>99</sup> DZN ★

© 2015 Little League Baseball, Incorporated, All Rights Reserved.

MARK 1

**NFHS APPROVED**

- NFHS approved
- COR. 47/375 max comp.
- Leather cover
- Raised stitch
- Poly-core

BSOSB	12"	\$53 <sup>99</sup> DZN ★
-------	-----	--------------------------

**PRACTICE**

- Slowpitch or fastpitch
- COR, compression, cover, center may vary

5PSBY11	11"	\$46 <sup>99</sup> DZN ★
5PSBY12	12"	\$46 <sup>99</sup> DZN ★

**NFHS FAST PITCH**

- NFHS approved
- COR. 47/375 lb max comp.
- Poly graphite center
- Leather cover
- Red stitch

MCSBI2YH	12"	\$63 <sup>99</sup> DZN ★
----------	-----	--------------------------

**ASA® FAST PITCH**

- ASA® approved
- Cor. 47 / 375 lb max comp
- Poly graphite center
- Leather cover
- Red stitch

MCSBI1YL	11"	\$59 <sup>99</sup> DZN ★
MCSBI2YL	12"	\$63 <sup>99</sup> DZN ★

**CORK CENTER ASA FAST PITCH**

- ASA® approved
- COR. 47/ 375 lb max comp.
- Cork center
- Leather cover
- White stitch

I280548	12"	\$46 <sup>99</sup> DZN ★
---------	-----	--------------------------

**SAFE/SOFT TRAINING**

- Perfect for drills
- Leather cover
- Tri-Flex safety core

MCSBI1SS	11"	\$56 <sup>99</sup> DZN ★
MCSBI2SS	12"	\$58 <sup>99</sup> DZN ★

**PONY® FAST PITCH**

- Pony approved
- COR. 47/375 lb max comp.
- Poly graphite center
- Leather cover

MCSBI1PNY	11"	\$58 <sup>99</sup> DZN ★
MCSBI2PNY	12"	\$62 <sup>99</sup> DZN ★

MacGregor **SLOW PITCH SOFTBALLS****X52RE ASA Slow Pitch**

- ASA approved
- COR 52/300 max. comp
- Poly graphite core
- Red stitching

1377375	12" - Synthetic Cover	\$47 <sup>99</sup> DZN ★
1377376	12" - Composite Cover	\$52 <sup>99</sup> DZN ★
1377377	12" - Leather Cover	\$62 <sup>99</sup> DZN ★

**X44RE ASA Slow Pitch**

- ASA® approved
- COR. 44 / 375 lb max comp.
- Yellow leather cover
- Red stitching
- Compressed cork core

I280517	11"	\$49 <sup>99</sup> DZN ★
---------	-----	--------------------------

**X44RP ASA® Slow Pitch**

- ASA® approved
- COR. 44/375 max compression
- Yellow leather cover
- Red stitching
- X100 poly graphite core

I184761	11"	\$58 <sup>99</sup> DZN ★
---------	-----	--------------------------

**POLY-CORE SLOW PITCH**

- No ASA markings
- COR. 47 / 375 max comp.
- Leather cover
- Poly graphite core
- Red stitching

I280531	12"	\$62 <sup>99</sup> DZN ★
---------	-----	--------------------------

## DUDLEY SOFTBALLS



### ASA THUNDER ZN HyCon

- ASA approved
- COR .52/300 lbs max comp
- Poly center
- Composite cover
- Red Stitch

1375626 12" \$74<sup>99</sup> DZN



### THUNDER SY CLASSIC W SLOW PITCH

- USSSA approved
- COR .44/400 lbs max comp.
- Classic W stamped
- Synthetic cover / poly center

1300291 11" \$54<sup>99</sup> DZN



### THUNDER SY USSSA SLOW PITCH

- USSSA approved
- COR .40/325 lbs max comp.
- Classic M stamped
- Synthetic cover / poly graphite center

1265996 12" \$59<sup>99</sup> DZN



### ASA THUNDER HEAT HyCon

- ASA approved
- COR .52/300 lbs max comp
- Poly center
- Leather cover
- Red stitch

1375625 12" \$84<sup>99</sup> DZN



### THUNDER ADVANCE MLT

- Non-association ball
- 12" COR .44/375 lbs max comp.
- Advance MLT series tech.
- Composite cover / poly center
- Blue stitch

1300284 12" \$72<sup>99</sup> DZN



### OFFICIAL LITTLE LEAGUE FAST PITCH

- Official Little League softball
- Cor .47/375 lb max comp
- Cork center
- Leather cover

1323764 11" \$74<sup>99</sup> DZN



### THUNDER ZN USSSA SLOW PITCH

- USSSA approved
- COR .47/450 lb max comp.
- Composite cover / poly center
- Stadium stamped

1265989 12" \$84<sup>99</sup> DZN



### ASA THUNDER SY HyCon

- ASA approved
- COR .52/300 lbs max comp
- Poly center
- Synthetic cover
- Red stitch

1375627 12" \$62<sup>99</sup> DZN



### SB12LND NFHS FAST PITCH

- NFHS approved
- COR .47/375 lb max comp.
- Cork center
- Leather cover

BBDUDYEL 12" \$82<sup>99</sup> DZN



### THUNDER HEAT NFHS FAST PITCH

- NFHS approved
- COR .47 / 375 lb max comp.
- Poly graphite center
- Leather cover

BBDNHFSY 12" \$86<sup>99</sup> DZN

## WORTH SOFTBALLS



### RED DOT FAST PITCH

- ASA / NFHS approved
- Cor .47/375 lb max comp
- Yellow leather cover
- 88 red stitch
- Poly X core

1385210 12" \$94<sup>99</sup> DZN



### BLUE DOT SLOW PITCH

- Not ASA approved
- COR .47 / 525 lb max comp.
- Pro Tac cover
- Poly graphite center
- C-LOK moisture barrier technology

1193930 12" \$74<sup>99</sup> DZN



### SUPER GREEN DOT SLOWPITCH

- ASA Approved
- Cor .44/375 lb max comp
- Red Stitch
- Pro Tac cover

1385212 11" \$65<sup>99</sup> DZN



### HOT DOT SLOWPITCH

- ASA Approved
- Cor .52/ 300 lb max comp
- Red stitch
- C-LOK technology

1385211 12" \$77<sup>99</sup> DZN



### SUPER GREEN DOT CLASSIC SLOW PITCH

- USSSA approved
- COR .44/ 400 lbs. max comp.
- Optic yellow Pro Tac cover
- Poly-core with C-Lok technology

1265781 11" \$74<sup>99</sup> DZN



### OFFICIAL NCAA CHAMPIONSHIP FAST PITCH

- Official NCAA championship ball
- COR .47/ 400 lb max comp.
- Polycore center
- Pro leather yellow cover
- Raised seam, red stitch

1193862 12" \$114<sup>99</sup> DZN



### SUPER GOLD DOT CLASSIC SLOW PITCH

- USSSA approved
- COR .40/325 lbs. max comp.
- Pro Tac cover
- Poly-core with C-Lok technology

1265774 12" \$74<sup>99</sup> DZN



### DREAM SEAM™ FAST PITCH

- ASA®/NFHS approved
- COR .47 / 375 lb max comp.
- Cork center
- Optic yellow leather cover
- Raised red stitching

5C11RYLADZN 11" \$89<sup>99</sup> DZN

5C12RYLADZN 12" \$89<sup>99</sup> DZN



**Wilson**

**NFHS Fast Pitch**

- NFHS Approved
- COR .47 / 375 lb Max Comp.
- Poly Graphite Center
- Leather Cover
- Red SST Stitching

**1371532** 12" \$93<sup>22</sup> DZN



**Baden**

**PERFECTION LEATHER FAST PITCH**

- NFHS approved
- COR .47 / 375 lb max comp.
- Leather cover
- Poly core

**1323429** 12" \$82<sup>22</sup> DZN



**Baden**

**ALL-WEATHER BASEBALLS**

- CoreGuard™ protects the ball from getting water logged
- Dries back to original weight and condition in 24 hours
- Available in blue stitch for high school/college or red stitch for Little League

**1237221** Blue Stitch - PR-O \$47<sup>22</sup> DZN  
**1266122** Red Stitch - LL Approved \$47<sup>22</sup> DZN

**SPECIALTY BALLS**



**UNBELIEVA-BALL**

- State of the art, sting free and safe!
- Made of a high density foam core surrounded by nylon windings and a heavy duty cloth cover.
- Raised seams for a more realistic feel.
- Machine washable and long lasting.
- Perfect training aid for both indoor and outdoor play.

**1300932** 9" Baseball - White \$49<sup>22</sup> DZN ★  
**1300949** 11" Softball - Yellow \$63<sup>22</sup> DZN ★  
**1300956** 12" Softball - Yellow \$64<sup>22</sup> DZN ★  
**1300963** 12" Softball - White \$64<sup>22</sup> DZN ★  
**1300970** 16" Softball - White \$13<sup>22</sup> EA ★



**EASTON**

**SOFTSTITCH™ INCREDIBALL®**

- INCREDIBALL® sting free, safe, softsound balls with a lockstitch, double-knit cover.
- Washable, and will last as long as a regular ball.
- Carries 75% of distance when hit.
- A great training aid for indoors or outdoors.

**BBSS9W** 9" Baseball - White \$56<sup>22</sup> DZN  
**BBSS11Y** 11" Softball - Yellow \$67<sup>22</sup> DZN  
**BBSS12Y** 12" Softball - Yellow \$67<sup>22</sup> DZN



**EASTON**

**SOFTOUCH™ INCREDIBALL®**

- Features a unique safety core for limited flight and reduced injuries
- Polyurethane core with durable synthetic leather cover
- Perfect for younger game play or indoor/outdoor training for all ages

**BBST9W** 9" Baseball - White \$59<sup>22</sup> DZN  
**BBST11Y** 11" Softball - Yellow \$66<sup>22</sup> DZN  
**BBST12Y** 12" Softball - Yellow \$66<sup>22</sup> DZN

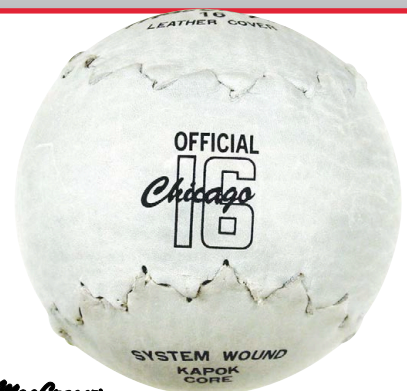

**MacGregor**

**CHICAGO 16"**

- Leather
- COR .47
- Kapok center

**MCSB16CH** 16" \$19<sup>22</sup> EA ★

## PITCHING MACHINE BALLS



### SUPER SOFT TRAINING BALL

- Compare to SFT® Supersoft™ balls
- Perfect indoor training ball

<b>1155020</b>	9" Baseball	\$27 <sup>99</sup> DZN ★
<b>1155037</b>	12" Softball	\$29 <sup>99</sup> DZN ★

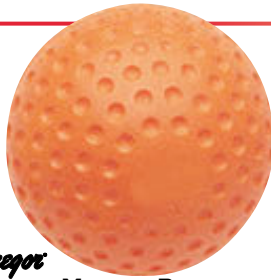

**MacGregor**

### SOFT ORANGE MACHINE BALL

- Compare to ATEC Tuffy® dimpled balls
- Developed for use with metal bats
- Softer than standard rubber or polyurethane dimple balls

<b>1154979</b>	12" Softball	\$39 <sup>99</sup> DZN ★
<b>1154962</b>	9" Softball	\$29 <sup>99</sup> DZN ★



**MacGregor**

### DIMPLED MACHINE BALLS

- Soft, durable yellow polyurethane
- Designed safe for aluminum bats

<b>MCBDBYEL</b>	9" Baseball	\$28 <sup>99</sup> DZN ★
<b>BBDSBALL</b>	12" Softball	\$34 <sup>99</sup> DZN ★



**NEW!**



### Hi.PER PRO LEATHER MACHINE BASEBALL

- Premium full grain leather balls with cushioned cork center
- High tensile strength accu-seams
- Regulation size and weight
- Aerodynamically optimized for pitching machine use

<b>1383988</b>		\$71 <sup>42</sup> DZN
----------------	--	------------------------



### SEAMED PITCHING MACHINE BALLS

- Patented red seamed dimpled pitching machine ball
- Inset seams will not come in contact with machine wheels protecting red seams from wear
- Baseball appearance trains batter's eye for the real pitch

<b>1237269</b>	9" White Baseball	\$49 <sup>99</sup> DZN
<b>1237276</b>	12" Yellow Softball	\$54 <sup>99</sup> DZN



**MacGregor**

### LITE MACHINE BALLS WITH SEAMS

- Compare to ATEC SFT® balls
- Ideal training ball for all ages
- Designed safe for indoor/outdoor
- Will travel as far as a regulation ball
- Works in most pitching machines

<b>1155006</b>	9" Baseball	\$24 <sup>99</sup> DZN ★
<b>1155013</b>	12" Softball	\$38 <sup>99</sup> DZN ★

## TRAINING BALLS



### HEAVY DUTY PLASTIC BASEBALL

- Seamless, perforated plastic with a thicker wall structure for increased durability

Color Options: **Orange, White, Yellow.**

<b>1050XXXX</b>	Specify Color	\$36 <sup>99</sup> DZN
-----------------	---------------	------------------------



### PLASTIC 'CURVE' BALL

Unique hole design allows for easy curveball action.

<b>3192XXXX</b>	12" Softball	\$1 <sup>99</sup> EA
-----------------	--------------	----------------------



### PLASTIC TRAINING BALLS

- Designed for true slow and limited flight

<b>1033601</b>	9" Baseball	\$8 <sup>99</sup> SET OF 6 ★
<b>1033618</b>	12" Softball	\$9 <sup>99</sup> SET OF 6 ★



### 9" WIFFLE™ BALL BASEBALL

Designed for true slow and limited flight. 9" baseball size.

<b>1141245</b>	Wiffle™ 9" Baseball	\$1 <sup>99</sup> EA
----------------	---------------------	----------------------



### TCB SUPER WEIGHTED BALLS

- Approx. 5.2"D - Softball size
- Weighs 900 grams
- Use for soft toss or tee work
- Strength development for the core and upper body

<b>1371403</b>	TCB Atomic Balls (set of 6)	\$65 <sup>99</sup> SET
----------------	-----------------------------	------------------------



### TCB TRAINING BALLS

- Approx. 3.2"D - Baseball Size
- Used for soft toss, front toss and tee work
- Helps players "drive-thru" the hitting zone
- Ball weighs 425 grams

<b>1371400</b>	Weighted	\$99 <sup>99</sup> DZN
----------------	----------	------------------------



### TCB TRAINING BALLS

- Perfect for front toss drills
- Great for hand eye coordination
- Hits better, throws better than ordinary plastic balls
- Designed to last

<b>1371401</b>	With Holes - Golf Ball Size	\$31 <sup>99</sup> DZN
<b>1371402</b>	With Holes - Baseball Size	\$44 <sup>99</sup> DZN

**1. BUCKET w/ BASEBALLS**

- Bucket with 3 dz. MacGregor 79P practice baseballs (MCB79PXX)
- 6 gallon plastic bucket w/ cushioned lid
- Holds up to 5 dz. baseballs or 2 dz. softballs

1378434 Bucket w/ balls \$112<sup>22</sup> EA ★  
 1378375 Bucket Only \$19<sup>22</sup> EA H

**2. BUCKET w/ MARK I BALLS**

- Bucket with 3 dz Mark I Official League Baseballs (BSOLB)
- Heavy duty 6 gallon plastic bucket with cushioned lid

1378435 Bucket w/balls \$107<sup>22</sup> EA ★

**3. BUCKET w/ SOFTBALLS**

- 2 dz. practice softballs
- COR, compression, cover, center and brand of balls may vary.

1378432 11" \$89<sup>22</sup> EA ★  
 1378433 12" \$89<sup>22</sup> EA ★

*Rawlings***BUCKET w/PRACTICE BALLS**

- 6 gal. bucket with padded seat filled with 3dz. Rawlings ROLBIX baseballs

1265965 \$144<sup>22</sup> PACK



Bucket not  
included

**SWIVEL BUCKET SEAT**

- Nylon cover with 1" thick foam cushion
- Swivel seat snaps onto a 12" diameter standard ball bucket
- Color: Black, Maroon, Red, Royal, Navy

K10317 Specify Color \$39<sup>22</sup> EA

*EASTON***COACH'S BUCKET COVER**

- Includes soft cushioned top, pockets for pens & line-up cards, a zipper pocket, and a mesh pocket for three game balls

1237238 \$29<sup>22</sup> EA

*Diamond***BALL BUCKET**

- Holds up to 5 dz baseballs
- Padded seat for comfort

1404890 \$23<sup>22</sup> EA

**BATTING PRACTICE BALL CART**

- Constructed of heavy duty 1.5" O.D. powder coated steel
- Large capacity basket: 16"H x 20"W x 25"L
- Holds hundreds of balls
- Oversize 14" No-flat tires

1291568 \$219<sup>22</sup> EA ★  
 1375102 Replacement wheel \$24<sup>22</sup> EA ★



Balls not included

**FOLDABLE BALL BIN**

- Waist high ball bin-ideal for soft toss or normal BP
- Foldable design allows for easy storage
- Holds over 100 baseballs or over 50 softballs

1361841 \$74<sup>22</sup> EA ★

**ADJUSTABLE FIELD BALL CART**

- Heavy duty molded plastic hopper and large rear wheels for easy mobility
- Legs are height adjustable to raise or lower hopper height
- Holds 200 baseballs/100 softballs

1232707 \$394<sup>22</sup> EA



Easy Adjust Leg

*WSU*  
WHILE SUPPLIES LAST**ADJUSTABLE BASEBALL BASKET**

- Heavy duty 1-1/2" steel.
- Telescopic legs adjust height.
- 5dz. baseballs or 3dz. softballs.

1162561 \$129<sup>22</sup> EA ★



## BATTING TEES

**NEW!**



### UTILITEE STAND COMPLETE

- All-weather, urethane upper and steel lower shaft for superior impact resistance
- Adjustable from 24" - 42"
- Durable steel collapsible tripod legs and easily fits over any home plate
- Available with a brush top, mesh top or wrap top
- Optional attachment pack includes: Classic Brush Top, Perfect Cut, Cast-away, In and out, protective caps and carry case

1384022	Specify Top	\$89 <sup>99</sup> EA
1384025	Attachment Pack	\$89 <sup>99</sup> EA



### VARSITY 5 POSITION BATTING TEE

- Rugged hard-rubber construction
  - Learn to control ball contact points for inside, outside and down the middle
  - Allows over 20 different drill positions
  - Adjustable from 20" - 39"
- 10 Year Limited Warranty**

1154818	Complete Tee	\$57 <sup>99</sup> EA ★
1249897	Replacement Top Tube	\$8 <sup>99</sup> EA ★



### OFFICIAL BATTING TEE

- Constructed of durable rubber components
- Features a solid metal base for added weight
- Adjustable hitting height from 20" to 36"
- Ideal for training players of all ages

BBBATTEE	Black Tee	\$29 <sup>99</sup> EA ★
BBBATTUB9	Black Replacement Inside Tube	\$7 <sup>99</sup> EA ★



### TRAVEL TEE

- Lightweight, portable hitting tool for baseball or softball
- Breaks down for easy transport
- Telescoping tee allows you to adjust the height of the tee (29"-47")
- Includes a water-resistant carrying bag

512830600	Complete Travel Tee	\$41 <sup>99</sup> EA
1036978	Replacement Top	\$8 <sup>99</sup> EA

**NEW!**



### TANNER TEE

- Steel shaft has telescoping height adjustment
- Flexible ball rest for minimal resistance
- Breaks down easy for travel

K11059	Standard Tee (26" - 43")	\$79 <sup>99</sup> EA
K11060	Short Tee (20" - 32")	\$79 <sup>99</sup> EA



### BATTING TEE

- Outstanding durability and portability
- Polyethylene base with adjustable shaft
- Flexible fiber top shaft and rubber cup

1375574	22" - 41"	\$124 <sup>99</sup> EA
1375575	26" - 53"	\$129 <sup>99</sup> EA
1375576	Low Ball Attachment - 16"H	\$37 <sup>99</sup> EA
1375577	Low Ball Attachment - 19"H	\$39 <sup>99</sup> EA
1375578	Extra Rubber Cup	\$24 <sup>99</sup> EA
1375579	Optional 10lb weight plate	\$24 <sup>99</sup> EA



### TUFFY® TEE

- High strength polyurethane materials for unmatched durability
  - Adjusts from 20" to 39"
- 10 Year Limited Warranty**

TUFFTEE1	Single Tee	\$124 <sup>99</sup> EA
----------	------------	------------------------

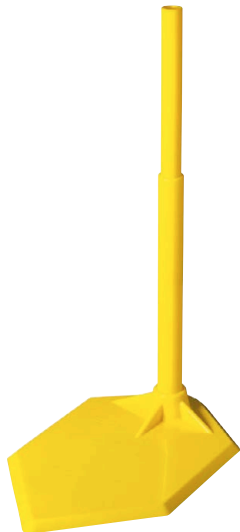

**NEW!**



### ELI'S SPRINGBACK BATTING TEE

- Tee can telescope 42" high and 26" low
- Used by youth players all the way up to the major league level.
- Comes with a weighted base, spring coil action and untearable rubber top cover

1385407	42"	\$99 <sup>99</sup> EA
---------	-----	-----------------------





# # OWN THE PLATE



[facebook.com/LouisvilleSlugger](https://facebook.com/LouisvilleSlugger)
[facebook.com/LouisvilleFastpitch](https://facebook.com/LouisvilleFastpitch)
[@SluggerNation](https://twitter.com/SluggerNation)
[@SluggerFP](https://twitter.com/SluggerFP)
[@SluggerNation](https://instagram.com/SluggerNation)
[@SluggerFP](https://instagram.com/SluggerFP)



### PRIME 916 [-3] BBCOR

31"/28	32"/29	33"/30	34"/31	1391233	-3	\$399.99
--------	--------	--------	--------	---------	----	----------

- Fused Carbon Structure composite design
- 3-piece construction with Flex Band barrel technology
- 31/32" papered handle with Lizard Skins grip



### SELECT 716 [-3] BBCOR

31"/28	32"/29	33"/30	34"/31	1391237	-3	\$299.99
--------	--------	--------	--------	---------	----	----------

- 100% composite handle with AC21 alloy barrel
- 3-piece bat construction with Flex Band technology
- 31/32" tapered handle with Lizard Skins grip



### OMAHA 516 [-3] BBCOR

29"/26	30"/27	31"/28	32"/29	32 5/8"/29 5/8"	33"/30	34"/31	1391241	-3	\$199.99
--------	--------	--------	--------	-----------------	--------	--------	---------	----	----------

- Historical bat synonymous with great high school and college hitters
- 7U1 alloy design with Flex Band technology
- 31/32" tapered handle with Lizard Skins grip



### LXT PLUS [-10] FASTPITCH

30"/20	31"/21	32"/22	33"/23	34"/24	1391848	-10	\$349.99
--------	--------	--------	--------	--------	---------	-----	----------

- Performance plus composite double wall design
- 3-piece construction with TRU3 - explosive power transfer
- 7/8" standard handle



### XENO PLUS [-10] FASTPITCH

30"/20	31"/21	32"/22	33"/23	34"/24	1391248	-10	\$299.99
--------	--------	--------	--------	--------	---------	-----	----------

- Performance PLUS Composite with zero friction double wall design
- 2-piece construction with iST connection technology
- SiID barrel technology and balanced swing weight



[facebook.com/DemariniSports](https://facebook.com/DemariniSports)
[@DeMarini](https://twitter.com/DeMarini)  
[@DemariniFP](https://instagram.com/DemariniFP)
[@DemariniNation](https://instagram.com/DemariniNation)



### CFB [-3] BBCOR

30"/27	31"/28	32"/29	33"/30	34"/31	1391884	-3	\$449.95
--------	--------	--------	--------	--------	---------	----	----------

- Paradox +Plus composite barrel for light swing weight
- D-Fusion 2.0 handle reduces vibration
- Low Pro end cap optimizes swing weight, sound and feel



### VOODOO RAW [-3] BBCOR

30"/27	31"/28	32"/29	32 5/8"/29 5/8"	33"/30	33 5/8"/30 5/8"	34"/31	1391889	-3	\$299.95
--------	--------	--------	-----------------	--------	-----------------	--------	---------	----	----------

- Alloy barrel with a slightly end loaded feel for power
- D-Fusion 2.0 handle reduces vibration
- Low Pro end cap optimizes swing weight, sound and feel



### NVS VEXXUM [-3] BBCOR

31"/28	32"/29	33"/30	34"/31	1391229	-3	\$199.99
--------	--------	--------	--------	---------	----	----------

- NVS barrel design featuring X12 alloy
- C6 composite handle provides stability and responsiveness
- Big D end cap absorbs vibration while keeping swing weight low



### CFB [-10] BALANCED FASTPITCH

30"/20	31"/21	32"/22	33"/23	34"/24	1391896	-10	\$349.95
--------	--------	--------	--------	--------	---------	-----	----------

- Paradox +Plus composite barrel
- D-Fusion 2.0 handle reduces vibration and redirects energy into the barrel
- Low Pro end cap optimizes swing weight, sound and feel



### CFB [-10] SLAPPER FASTPITCH

31"/21	32"/22	33"/23	34"/24	1391901	-10	\$349.95
--------	--------	--------	--------	---------	-----	----------

- Paradox +Plus composite barrel
- D-Fusion 2.0 handle reduces vibration and redirects energy into the barrel
- Low Pro end cap optimizes swing weight, sound and feel



### CFB [-11] FASTPITCH

28"/17	29"/18	30"/19	31"/20	32"/21	33"/22	1391905	-11	\$349.95
--------	--------	--------	--------	--------	--------	---------	-----	----------

- Paradox +Plus composite barrel
- D-Fusion 2.0 handle reduces vibration and redirects energy into the barrel
- Dish end cap

**BBCOR CERTIFIED .50 HIGH SCHOOL/COLLEGE**



**EASTON S400 BBCOR (-3)**

• Durable alluminum alloy, tapered handle with All Sports grip  
 Size: 30", 31", 32", 33", 34".  
 1391735 Specify Length \$79<sup>22</sup> EA



**EASTON S200 BBCOR (-3)**

• Durable aluminum alloy, tapered handle  
 Size: 30", 31", 32", 33", 34".  
 1391730 Specify Length \$59<sup>22</sup> EA

**YOUTH**  
 All bats are stamped 1.15 BPF.  
 Approved for Little League & all other association.



**EASTON S500 YOUTH (-13)**

• 7050 alloy for fast swing speed  
 Size: 27", 28", 29", 30", 31", 32".  
 1377510 Specify Length \$69<sup>22</sup> EA



**Rawlings RX4 (-13)**

• Performance end cap and knob creates a balanced feel  
 Length: 27", 28", 29", 30", 31".  
 1380035 Specify Length \$64<sup>22</sup> EA



**LOUISVILLE SLUGGER ARMOR (-12)**

• Alloy construction with tapered handle  
 Length: 27", 28", 29", 30", 31".  
 1385153 Specify Length \$49<sup>22</sup> EA



**EASTON S200 (-10)**

• Durable alloy, ultra-thin 29/32" handle  
 Length: 27", 28", 29", 30", 31", 32".  
 1391746 Specify Length \$34<sup>22</sup> EA



**EASTON S50 (-10)**

• Durable aluminum alloy, full rolled over end  
 Length: 26", 27", 28", 29", 30", 31".  
 1391740 Specify Length \$24<sup>22</sup> EA

**TEE BALL**



**LOUISVILLE SLUGGER TBALL PRIME (-13.5)**

• Alloy construction with standard handle  
 Length: 24", 25", 26".  
 1385158 Specify Length \$39<sup>22</sup> EA



**Rawlings RAPTOR T-BALL (-13)**

• Features a large sweet spot for better contact  
 Length: 24", 25", 26".  
 1380040 Specify Length \$29<sup>22</sup> EA



**EASTON MAKO TEE BALL**

• Aluminum alloy, thin handle, rolled end  
 Length: 24", 25", 26".  
 1391752 Specify Length \$24<sup>22</sup> EA

**WARNING: Batted balls may cause injury. Use bats with caution.**

**BBCOR CERTIFIED .50 HIGH SCHOOL/COLLEGE**



**EASTON MAKO BBCOR (-3)**

• Balanced barrel design, massive sweet spot, two piece design  
 Size: 31", 32", 33", 34".  
 1391761 Specify Length \$449<sup>22</sup> EA



**Rawlings VELO BBCOR (-3)**

• Acoustic-Performance maximizes alloy strength, large sweet spot  
 Size: 31", 32", 32.5", 33", 33.5", 34".  
 1391268 Specify Length \$299<sup>22</sup> EA



**MARUCCI CAT6 BBCOR (-3)**

• Ring-free barrel technology, one-piece alloy construction  
 Size: 31", 32", 33", 34".  
 1383971 Specify Length \$249<sup>22</sup> EA



**EASTON Z-CORE BBCOR (-3)**

• Balanced barrel design for lighter swing weight index  
 Size: 30", 31", 32", 33", 34".  
 1391866 Specify Length \$199<sup>22</sup> EA



**Rawlings BBR53 5150 BBCOR (-3)**

• Ultra responsive 5150 alloy, Precision-Optimized-Performance  
 Size: 30", 31", 32", 33", 34".  
 1391274 Specify Length \$199<sup>22</sup> EA



**LOUISVILLE SLUGGER OMAHA 516 BBCOR (-3)**

• 7U1 alloy, flex band barrel tech., Lizard Skins grip  
 Size: 29", 30", 31", 32", 32.5", 33", 34".  
 1391241 Specify Length \$199<sup>22</sup> EA



**LOUISVILLE SLUGGER VAPOR BBCOR (-3)**

• Performance alloy with tapered handle  
 Size: 30", 31", 32", 33", 34".  
 1385149 Specify Length \$99<sup>22</sup> EA



**EASTON S500 (-3) BBCOR**

• 7050 aircraft alloy for fast swing speed, 31/32" tapered handle  
 Size: 31", 32", 33", 34".  
 1391871 Specify Length \$99<sup>22</sup> EA

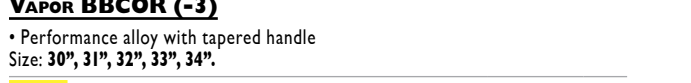

**Rawlings BBRP PRODIGY BBCOR (-3)**

• High performance alloy, extended sweet spot technology  
 Size: 32", 33", 34".  
 1391279 Specify Length \$99<sup>22</sup> EA

## MacGregor BATS WSU WHILE SUPPLIES LAST

### YOUTH BATS



#### X9 VIPER (-11)

- 7046 Alloy
- Thin handle w/synthetic grip
- 2-1/4" barrel w/capped end

• Meets & Stamped with I.15 BPF  
Length: **28", 29", 30", 31"**.

**1300598** Specify Length \$39<sup>22</sup> EA ★



#### X8 VIPER (-11)

- 6061 alloy
- 2-1/4" barrel w/rolled end
- Thin handle w/synthetic grip

• Meets & Stamped with I.15 BPF  
Length: **27", 28", 30", 32"**.

**1300642** Specify Length \$27<sup>22</sup> EA ★

### TEE BALL



#### VIPER TEE BALL (-11)

- 6061 alloy
- 2-1/4" barrel w/rolled end
- Thin handle w/rubber grip

• Meets and stamped w/I.15 BPF  
Length: **25", 26"**.

**1300703** Specify Length \$18<sup>22</sup> EA ★

### FASTPITCH



#### GRIZZLY X6SB FAST PITCH (-9)

- ASA certified
- 6061 alloy
- 2-1/4" barrel w/capped end

• Soft rubber grip  
Length: **27", 30", 31", 34"**.

**1300727** Specify Length \$35<sup>22</sup> EA ★



#### GRIZZLY X9SB FAST PITCH (-9)

- Not ASA certified
- 6061 alloy
- 2-1/4" barrel w/capped end

• 34" length with soft rubber grip  
Length: **29", 30", 31", 32", 34"**.

**1300802** Specify Length \$29<sup>22</sup> EA ★

### SLOWPITCH



#### GRIZZLY X10 SLOW PITCH (34")

- ASA certified
- 6061 alloy
- 2-1/4" barrel w/capped end

• 34" length with soft rubber grip  
Weight: **26 oz., 28 oz., 30 oz.**

**1300888** Specify Weight \$39<sup>22</sup> EA ★

### FUNGO BATS



#### EASTON

#### MLF5 MAPLE WOOD FUNGO

- 37"L with 7/8" handle and cupped end
- Color Options: **Black/Clear, Black/Navy, Black/Red, Black/Royal.**

**1184631** Specify Color \$52<sup>22</sup> EA



#### K100 FUNGO

- Ash fungo bat with natural finish

**1385178** 36" \$29<sup>22</sup> EA

**WARNING:** Batted balls may cause injury. Use bats with caution.

### WOOD BATS



#### NEW! marucci AP5 PRO MODEL

- Maple w/tapered knob abd handle, large barrel
- Size: **31", 32", 33", 34"**.

1389816 Black/Natural - Specify Length \$139<sup>22</sup> EA  
1389820 Natural/Black - Specify Length \$139<sup>22</sup> EA



#### NEW!

#### EASTON S3 Ash (-3)

- Pro-balanced speed design
- Length: **31", 32", 33", 34"**.

**1385236** Specify Length \$54<sup>22</sup> EA



#### Mizuno CLASSIC BAMBOO - NATURAL (-2)

- Exceptional durability with pro-cupped end.
- Size: **32", 33"**.

**1264944** Specify Length \$64<sup>22</sup> EA



#### R110MB MAPLE

- Medium sized barrel with maple wood construction and 1" handle
- Size: **31", 32", 33", 34"**.

**1391911** Specify Length \$59<sup>22</sup> EA



#### C271 PRO STOCK

- #1 grade ash with natural finish
- Length: **32", 33", 34"**.

**1385170** Specify Length \$49<sup>22</sup> EA



#### R212AB Ash

- Large barrel, ash bat with 31/32" handle
- Size: **31", 32", 33", 34"**.

**1391915** Specify Length \$34<sup>22</sup> EA



#### HARD MAPLE - YOUTH

- Youth hard maple with cupped end
- Length: **27", 28", 29", 30", 31"**.

**1385173** Specify Length \$19<sup>22</sup> EA



#### MacGregor BAT CADDY

- Heavy-duty 600 denier polyester.
- Hang on chain-link fence or dugout
- Holds up to 8 bats
- Mesh pockets for easy viewing.
- Conveniently rolls up for storage and transport
- Black only

**1187045** \$43<sup>22</sup> EA ★

## SLOW PITCH

Meet 1.20 BPF bat standard  
 ASA, USSSA, ISA, NSA, ISF approved

**WARNING:** Batted balls may cause injury. Use bats with caution.



### DeMARINI

#### ULTIMATE WEAPON SLOW PITCH (34")

• A wicked sweet spot that can stand up to each crushing blow  
 Weight: 26 oz., 28 oz., 30 oz..

1385203 Specify Weight \$119<sup>22</sup> EA



### EASTON

#### S500 SLOW PITCH (34")

• 7050 alloy for fast swing speeds  
 Weight: 26 oz., 28 oz., 30 oz..

1377552 Specify Weight \$89<sup>22</sup> EA



#### VAPOR SLOW PITCH (34")

• 7050 alloy design with tapered handle  
 Weight: 26 oz., 27 oz., 28 oz..

1385167 Specify Weight \$79<sup>22</sup> EA



### WORTH

#### AMP SLOW PITCH (34")

• End plug for improved swing control  
 Weight: 26.5 oz, 27.5 oz, 28.5 oz.

1385134 Specify Weight \$54<sup>22</sup> EA



### EASTON

#### S300 SLOW PITCH

• Durable aluminum alloy  
 Size: 33 in 26 oz, 34 in 28 oz, 34 in 30 oz.

1377555 Specify Weight \$39<sup>22</sup> EA



### EASTON

#### S50 SLOW PITCH

• Durable aluminum alloy with full rolled-over end  
 Size: 32 in 25 oz, 33 in 26 oz, 34 in 28 oz, 34 in 30 oz.

1377558 Specify Weight \$24<sup>22</sup> EA

## FAST PITCH

Meet 1.20 BPF bat standard  
 ASA, USSSA, ISA, NSA, ISF approved

**WARNING:** Batted balls may cause injury. Use bats with caution.



#### XENO PLUS FAST PITCH (-10)

• Balanced, 2-piece construction, zero friction double wall design  
 Size: 30", 31", 32", 33", 34".

1391248 Specify Length \$299<sup>22</sup> EA



### WORTH

#### 2LEGIT FAST PITCH (-10)

• Double-barrel four piece technology, 100% carbon fiber barrel  
 Size: 30", 31", 32", 33", 34".

1391853 Specify Length \$299<sup>22</sup> EA



#### PROVEN FAST PITCH (-13)

• Performance plus composite double wall design  
 Size: 28", 29", 30", 31", 32", 33".

1391253 Specify Length \$99<sup>22</sup> EA



### DeMARINI

#### UPRISING FAST PITCH (-12)

• Perfect balance for long lasting performance  
 Size: 28", 29", 30", 31", 32".

1385198 Specify Length \$79<sup>22</sup> EA



### WORTH

#### STORM HYPERLITE FAST PITCH (-13)

• Designed for players looking for an ultra-light feel  
 Size: 28", 29", 30", 31", 32".

1385124 Specify Length \$69<sup>22</sup> EA



#### FINCH FAST PITCH (-11.5)

• Reduced swing weight to help increase bat speed  
 Size: 27", 28", 29", 30", 31", 32", 33".

1385186 Specify Length \$69<sup>22</sup> EA



#### QUEST FAST PITCH (-12)

• Alloy construction with a bottle bat design  
 Size: 27", 28", 29", 30", 31", 32", 33".

1378363 Specify Length \$54<sup>22</sup> EA



### EASTON

#### MAKO YOUTH FAST PITCH (-11)

• Aluminum alloy with end cap  
 Length: 25", 26", 27", 28", 29", 30", 31".

1385229 Specify Length \$39<sup>22</sup> EA

**SERIES 3 STICK PACK**

- Durable 6000 polyester
  - Rip-stop accents
  - Multi-valuable pockets
  - Plush padding on back and shoulder straps
  - Holds 2 full size bats
- Color Options: **Black, Hot Pink, Purple, Royal, Scarlet.**



1377286 11"W x 5.5"D x 16"H \$19.99 EA

**SERIES 5 STICK PACK**

- Foam padding back and shoulder straps
  - Front cargo pocket for gear
  - Durable J-style fence hook
  - Holds 2 bats
- Color Options: **Black, Navy, Royal, Scarlet.**



1377265 12"W x 8"D x 18"H \$39.99 EA

**NEW!****EASTON E100XLP BAT PACK**

- Separate and vented shoe compartment
- Two side pockets for bats or water bottles
- Top pocket for personal items

Color Options: **Black/Camo, Chevron, Green/Camo, Navy/Camo, Orange/Camo, Red/Camo, Royal/Camo, White/Camo.**



1391282 20"H x 13"L x 8.5"W \$49.99 EA

**NOE2 CATCHER'S BAG**

- 9 unique pockets and compartments for storage
  - Shelving system to keep equipment organized
  - Holds up to (3) 34" bats
  - 4 hideaway hooks
  - Fat boy wheel technology
- Color Options: **Black, Navy, Red, Royal.**

1384017 Specify Color \$199.99 EA

**EASTON E500C CATCHER'S BAG**

- Pockets designed to meet the needs of a catcher
  - Full bottom rails and bracketed inline wheels
  - Vented pockets allow equipment to dry faster
  - Sport utility zipper configuration and fence hook
- Color Options: **Black, Green, Navy, Orange, Purple, Red, Royal, White.**

1391302 36"L x 12"W x 14"H \$99.99 EA

**Wilson PUDGE CATCHERS BAG ON WHEELS**

- Extra-large main compartment for equipment
- Side pockets for organizing valuables and accessories
- Holds up to 4 bats
- Telescopic pull handle with zip cover

1373555 38"L x 15"W x 13"H \$99.99 EA

**Rawlings COVERT PLAYER EQUIPMENT BAG**

- Removable top panel for personalization
  - Ventilated shoe compartment
  - Side bat sleeve compartments
- Color Options: **Black, Navy, Royal, Scarlet.**

1377668 26"L x 13"W x 13"H \$54.99 EA

**schutt CATCHER'S EQUIPMENT BAG**

- Features 600 denier polyester
- Heavy duty shoulder and handle straps
- Black only

512815506 35"L x 25"W x 19"H \$39.99 EA

**NEW!****EASTON WALK-OFF BACKPACK**

- Easton's #1 backpack redesigned!
- External helmet holder provides more space
- Vented shoe compartment, 2 side sleeves and fence hook
- Felt lined top pocket for personal items

Color Options: **Real Tree, Stars and Stripes, Torq Green, Black, Green, Maroon, Navy, Orange, Purple, Red, Royal, White.**



1391290 20"H x 14"L x 9.5"W \$79.99 EA

**SERIES 7 TON WHEELED BAG**

- High rise wheel chassis
  - Holds four bats
  - Removable personalization pannel
  - Separate compartment for footwear
- Color Options: **Black, Navy, Royal, Scarlet.**

1391259 35"L x 16.5"W x 14.5"H \$99.99 EA

**Mizuno MX EQUIPMENT WHEEL BAG**

- Easy access footwear compartment
- Accessory compartment for valuables
- Zip off embroidery panel
- Durable off road wheels
- Retractable handle
- Black only

5TBT46BK 36"L x 15"W x 15"H \$99.99 EA

**EASTON PERSONAL EQUIPMENT BAG**

- Large U shaped opening
- Heavy duty zipper design
- Black only

1377582 35"L x 15"W x 12"H \$35.99 EA

## EQUIPMENT BAGS



### TEAM EQUIPMENT BAG

- Heavy duty polyester equipment bag
- Rugged nylon zipper with wrap around handles
- Black only

**1377678** 33"L x 12"W x 15"H \$19<sup>99</sup> EA ★



### TEAM DUFFLE BAG

- Zip close compartments on both ends
  - Double handle carry straps
  - Padded shoulder harness
  - Denier Nylon with breathable air vents
- Color Options: **Black, Royal, Scarlet.**

**1377672** 27"L x 14"W x 12"H \$29<sup>99</sup> EA ★  
**1377675** 24"L x 12"W x 10"H \$24<sup>99</sup> EA ★



### VARSITY BAT BAG

- Tough vinyl material with a molded plastic round bottom
- The plastic bottom helps prevent tearing caused by dragging the bag
- Can hold up to 10 bats
- Black only

**1385396** 41"L x 10"W \$26<sup>99</sup> EA ★



### LARGE DUFFLE EQUIPMENT BAG

- Durable 600 denier polyester bag with a thick web shoulder strap and handle
- Military style closure
- Black only

**1385397** 33"L x 18"W \$24<sup>99</sup> EA ★



### BASEBALL/SOFTBALL EQUIPMENT TOTE

- Strong 600 denier polyester
- Will hold 15 bats and has a zippered top for easy closing
- Separate zippered outside pocket for softballs or baseballs
- Double reinforced bottom with standard shoulder straps
- Black only

**1385398** 39"L x 12"W \$34<sup>99</sup> EA ★



### BALL BAG

- Coated nylon with heavy duty carrying straps and zippered top
- Durable plastic bottom provides long lasting protection against water damage and mildew
- Holds 48 baseballs or 24 softballs
- Black only

**1385399** \$23<sup>99</sup> EA ★



### XL DUFFLE EQUIPMENT BAG

- Breathable heavy duty cotton canvas duck
- Durable leather reinforced bottom
- Complete with shoulder strap and handle
- Black only

**1385404** 42"L x 20"W \$27<sup>99</sup> EA ★

**BEST SELLER**

### PLAYERS BAT PACK

- Mid-sized backpack
- External side sleeves
- Interior room for a batting helmet and other gear
- 600D polyester construction
- Black only



**1385392** 14"L x 10"W x 19"H \$19<sup>99</sup> EA ★

### CATCHER'S EQUIPMENT BAG

- Heavy duty 600D polyester construction
- Professional strength carry straps
- Black only

**1385403** 35"L x 25"W x 19"H \$36<sup>99</sup> EA ★



### TEAM ROLLER BAG

- 600 denier polyester shell
- Concealed pull handle
- Padded shoulder strap
- In-line wheel kit
- Oversized accessory pockets on both ends

Color Options: **Black, Royal, Scarlet.**

**1385400** 38"L x 16"W x 15"H \$67<sup>99</sup> EA ★



## BATTING HELMETS



Rawlings

**S70 BATTING HELMET**

- Meets revised NOCSAE standards
- ABS plastic shell for classic performance
- Matte finish

Size: **Junior, Senior**Color Options: **Matte Black, Matte Graphite, Matte Navy, Matte Royal, Matte Scarlet, Matte White.**

<b>1380057</b>	Junior (6 1/2 - 7 1/8)	\$39 <sup>99</sup> EA
<b>1380051</b>	Senior (7 1/4 - 7 3/4)	\$39 <sup>99</sup> EA



Rawlings

**CFABHN BATTING HELMET**

- Meets revised NOCSAE standards
- Exclusive XVI venting technology to allow cooler air flow
- ABS plastic shell with dual density foam padding
- Optic orange crown liner and leather wrapped headband
- Clear coat finish

Color Options: **Black, Navy, Red, Royal**Size: **SML, MED, LRG, XLG.**

1385391	Specify Size & Color	\$39 <sup>99</sup> EA
---------	----------------------	-----------------------



EASTON

**Z5 GRIP TWO TONE BATTING HELMET**

- Meets revised NOCSAE standards
- High impact resistance providing an excellent protective shell
- High density shock absorbing foam
- Bio-dri liner helps absorb sweat
- Matte finish

Color Options: **Black/White, Green/White, Maroon/White, Navy/White, Orange/White, Purple/White, Red/White, Royal/White, White/Black.**

<b>1385276</b>	Junior (6 3/8 - 7 1/8)	\$49 <sup>99</sup> EA
<b>1385267</b>	Senior (6 7/8 - 7 5/8)	\$49 <sup>99</sup> EA



EASTON

**Z5 GRIP BATTING HELMET**

- Meets revised NOCSAE standards
- Matte finish
- Dual-density shock absorbing foam
- Bio-dri liner helps absorb sweat

Color Options: **Black, Gold, Green, Maroon, Navy, Orange, Purple, Red, Royal, Texas Orange, Vegas Gold, White.**

1385259	Junior (6 3/8 - 7 1/8)	\$39 <sup>99</sup> EA
<b>1385243</b>	Senior (6 7/8 - 7 5/8)	\$39 <sup>99</sup> EA

**NEW!**  
**RIP-IT****VISION PRO BATTING HELMET**

- NOCSAE approved fastpitch Softball Helmet
  - Blackout technology reduces glare
  - S/M fits sizes 6 - 6 7/8; M/L fits sizes 6 1/2 - 7 3/8; XL fits size 7 1/4+
- Color Options: **Away-Black, Away-Lt Blue, Away-Purple, Away-Royal, Away-Scarlet, Home-Black, Home-Lt Blue, Home-Purple, Home-Royal, Home-Scarlet, Home-Green, Home-Maroon, Home-Navy, Home-Orange**
- Size: **S/M, M/L, XL.**

1385315	Specify Size and Color	\$59 <sup>99</sup> EA
---------	------------------------	-----------------------



BATTING HELMETS



**NEW!**

*Rawlings*

**VENTED BATTING HELMETS**

- Meets revised NOCSAE standards
- Sleek design with superior venting system
- One size fits most with self adjusting fit
- ABS shell with dual density foam
- Pre-drilled for facemask
- Black only

<b>1383944</b>	Junior (6 1/4 - 6 7/8)	\$18 <sup>99</sup> EA
<b>1383945</b>	Youth (6 1/2 - 7 1/2)	\$18 <sup>99</sup> EA
<b>1383946</b>	Youth w/Attached Mask (6 1/2 - 7 1/2)	\$27 <sup>99</sup> EA
<b>1059106</b>	RWG2 Face Guard (Black Only)	\$17 <sup>99</sup> EA
RWRCSI	Elastic Chin Straps (dz)	\$17 <sup>99</sup> DZ



**NEW!**

*Rawlings*

**TWO-TONE VENTED BATTING HELMETS**

- Meets revised NOCSAE standards
- Unique two-tone fade design
- Sleek profile with superior venting system
- One size fits most with self adjusting fit
- ABS shell with dual density foam
- Pre-drilled for facemask
- Glossy finish

Color Options: **Navy, Royal, Scarlet.**

<b>1383947</b>	Junior (6 1/2 - 6 3/4)	\$23 <sup>99</sup> EA
<b>1383950</b>	Youth (6 1/2 - 7 1/2)	\$23 <sup>99</sup> EA
<b>1059106</b>	RWG2 Face Guard (Black Only)	\$17 <sup>99</sup> EA
RWRCSI	Elastic Chin Straps (dz)	\$17 <sup>99</sup> DZ



**NEW!**

*Rawlings*

**MATTE BATTING HELMETS**

- Meets revised NOCSAE standards
- Matte finish
- Sleek design with superior venting system
- One size fits most with self adjusting fit
- ABS shell with dual density foam
- Pre-drilled for facemask

Color Options: **Black, Royal, Scarlet.**

<b>1383956</b>	Junior (6 1/4 - 6 3/4)	\$26 <sup>99</sup> EA
<b>1383959</b>	Youth (6 1/2 - 7 1/2)	\$26 <sup>99</sup> EA
<b>1059106</b>	RWG2 Face Guard (Black Only)	\$17 <sup>99</sup> EA
RWRCSI	Elastic Chin Straps (dz)	\$17 <sup>99</sup> DZ



**NEW!**

*Rawlings*

**RCFH OSFM BATTING HELMET**

- Meets NOCSAE standards
- Molded finish
- Traditional COOLFLO design
- Pre-drilled for face guard

Color Options: **Black, Navy, Royal, Scarlet.**

<b>1391875</b>	OSFM (6 1/2 - 7 1/2)	\$22 <sup>99</sup> EA
<b>1059106</b>	RWG2 Face Guard (Black Only)	\$17 <sup>99</sup> EA



## Rawlings CATCHER'S HELMETS



**NEW!**

### TWO-TONE CATCHER'S HELMET

- Meets revised NOCSAE standards
- Meets all NFHS requirements
- Sleek two-toned design and fit
- Clearview wire design for optimum visibility
- Multiple air vents
- Adjustable back plate

Color Options: **Black, Royal, Scarlet.**

**1383965** Varsity (7 1/8 - 7 3/4) \$69<sup>22</sup> EA

**1383968** Youth (6 1/2 - 7) \$69<sup>22</sup> EA



**schutt**

### VENTED CATCHER'S HELMET/MASK

- ABS vented shell with attached hollow-wire mask
  - Sizes: small (6-5/8 - 7-1/2); large (7 - 7-3/4)
- Color Options: **Black, Navy, Royal, Scarlet**  
Size: **SML, LRG.**

**1035940** Specify Size & Color \$49<sup>22</sup> EA



**NEW!**

### OSFM CATCHER'S HELMET COMBO

- Meets revised NOCSAE standards
- Features rugged, durable ABS shell
- Dual foam liner with vents large air vents
- One size fits most

Color Options: **Black, Royal, Scarlet.**

**1383962** Fits Sizes 6 1/2 - 7 1/2 \$41<sup>22</sup> EA



**MacGregor**

### THROAT PROTECTOR

- Molded high-impact ABS plastic
  - Hook-and-Loop fastens onto mask
  - Fits all makes of masks
- Color Options: **Royal, Scarlet, Black, Navy.**

**MCB22Y** 4" long \$3<sup>22</sup> EA ★

## MacGregor CHEST PROTECTORS

All available in **BLACK ROYAL SCARLET**



### MCB75 JUNIOR CHEST PROTECTOR

**1298345** Ages 5 to 8 \$34<sup>22</sup> EA ★



### MCB74 YOUTH CHEST PROTECTOR

**1298376** Ages 9 to 12 \$34<sup>22</sup> EA ★



### MCB73 PREP CHEST PROTECTOR

**1298406** Ages 13 to 15 \$39<sup>22</sup> EA ★



### MCB70 PRO CHEST PROTECTOR

**1298437** Ages 15+ \$40<sup>22</sup> EA ★



### MCB80/81 FEMALE CHEST PROTECTORS

**B45-1298475** Varsity \$39<sup>22</sup> EA H  
**B45-1298505** Youth \$36<sup>22</sup> EA H

## MacGregor LEG GUARDS

All available in **BLACK ROYAL SCARLET**

Double Knee



Single Knee



### B62 JUNIOR SINGLE KNEE

- 9" shin plate
- Protection area of 18"
- Black only

**1159318** Ages 5-8 \$39<sup>22</sup> PR ★

### B68 JUNIOR DOUBLE KNEE

- 9" shin plate
- Protection area of 20"

**1159431** Ages 5-8 \$39<sup>22</sup> PR ★

### B65 YOUTH SINGLE KNEE

- 10" shin plate
- Protection area of 21"

**1159370** Ages 9-12 \$36<sup>22</sup> PR ★

### B64 YOUTH DOUBLE KNEE

- 10" shin plate.
- Protection area of 23"

**1159349** Ages 9-12 \$39<sup>22</sup> PR ★

### B66 PREP DOUBLE KNEE

- 11" shin plate
- Full-wing ankle protectors
- Protection area of 25"

**1159400** Ages 12-15 \$44<sup>22</sup> PR ★

### B61 VARSITY DOUBLE KNEE

- 12" Shin plate
- Full ankle and calf wing

**1159288** Ages 15+ \$59<sup>22</sup> PR ★

### LEG GUARD REPLACEMENT STRAPS

Replacement straps for catcher's leg guards. Black only.

**1012187** Black only \$19<sup>22</sup> DZN ★



**MacGregor**

### CATCHER'S KNEE SUPPORT

- Supports and cushions the knee, minimizing the stress on the knee in the catcher's position
- Attach to the leg guard straps
- Black only

**1184747** Adult Size \$19<sup>22</sup> PR ★

**1184754** Youth Size \$19<sup>22</sup> PR ★

**MacGregor CATCHER'S GEAR PACKS** All available in **BLACK ROYAL SCARLET**

**BASEBALL/SOFTBALL**



**\$89<sup>99</sup>**

**JUNIOR CATCHER'S GEAR PACK**

- Adjustable catcher's helmet
- MCB75 junior chest protector
- Junior double knee leg guards
- 4" throat protector

**1186895** Ages 5-8 **\$89<sup>22</sup>** PACK ★



**\$99<sup>99</sup>**

**YOUTH CATCHER'S GEAR PACK**

- Adjustable catcher's helmet
- MCB74 youth chest protector
- Youth double knee leg guards
- 4" throat protector

**1186833** Ages 9 - 12 **\$99<sup>22</sup>** PACK ★



**\$149<sup>99</sup>**

**PREP CATCHER'S GEAR PACK**

- Pro style varsity catcher's helmet
- MCB73 prep chest protector
- Prep double knee guards
- 4" throat protector

**1186864** Ages 12 - 15 **\$149<sup>22</sup>** PACK ★



**\$164<sup>99</sup>**

**VARSTIY CATCHER'S GEAR PACK**

- Pro-style varsity catcher's helmet
- MCB70 varsity chest protector
- Varsity double knee leg guards
- 4" throat protector

**1186802** Ages 15 + **\$164<sup>22</sup>** PACK ★



**GIRL'S FAST PITCH CATCHER'S GEAR PACK**

- Package Includes:
- Adjustable catcher's combo helmet
  - MCB81 girls chest protector
  - Youth double knee leg guards
  - 4" throat protector

**1186956** Ages 9 - 13 **\$97<sup>22</sup>** PACK ★



**VARSTIY FAST PITCH CATCHER'S GEAR PACK**

- Package includes:
- Pro style varsity catcher's helmet
  - MCB80 varsity female chest protector
  - Prep double knee leg guards
  - 4" throat protector

**1186925** Ages 14 + **\$149<sup>22</sup>** PACK ★

**FAST PITCH CATCHER'S EQUIPMENT**



**NEW!**  
**EASTON**

**M7 FAST PITCH CATCHER'S SET**

- Includes fast pitch catcher's helmet, M7 chest protector and leg guards
  - Age 13-15 set includes helmet (6 1/8" - 7"); 15" chest protector and 15.5" leg guards
  - Age 9-12 set includes helmet (6 1/8" - 7"); 13" chest protector and 14" leg guards
- Color Options: **Black, Navy, Red, Royal.**

**1391858** Age 13-15 - Specify Color **\$209<sup>22</sup>** EA  
**1391862** Age 9-12 - Specify Color **\$199<sup>22</sup>** EA

**YOUTH CATCHER'S EQUIPMENT**



**EASTON**

**BLACK MAGIC CATCHERS GEAR SETS**

- **Youth Set:** catchers helmet (6"-7"); chest protector (15"); leg guards (12.75")
- **Junior Set:** catchers helmet (6"-7"); chest protector (14"); leg guards (11.5")
- Black only

**1279344** Ages 9 - 12 **\$134<sup>25</sup>** EA  
**1279337** Ages 7 - 9 **\$134<sup>22</sup>** EA

## CATCHER'S GEAR

EASTON

## STEALTH CATCHERS HELMET

- Translucent polycarbonate shell
- VRS technology, lightweight and long-lasting gel-injected foam pads to reduce shock and vibration
- Comfort chin pad
- Black only

1373480 Small (6 1/8" - 7") \$139<sup>22</sup> EA

## FORCE CHEST PROTECTOR

- Form-fitting design with lightweight protective foam for maximum protection and mobility
- Outer foam layer to deaden ball upon impact
- Removable groin protector on intermediate and youth sizes only
- Black only

1373481 Adult - 17" \$119<sup>22</sup> EA1373482 Intermediate - 15" \$109<sup>22</sup> EA1373483 Youth - 13" \$99<sup>22</sup> EA

## FORCE LEG GUARD

- Triple kneecap design for maximum protection
- Ergonomically designed shin and knee plates provide durable protection
- Comfort foam liners cradles the shin and knee for a comfort fit
- Black only

1373484 Adult - 16" \$119<sup>22</sup> EA1373485 Intermediate - 14" \$109<sup>22</sup> EA1373486 Youth - 12.75" \$99<sup>22</sup> EANEW!  
schutt

## AIR MAXX CATCHER'S HELMET

- TPU cushioning performs more consistently across a wider temperature range than traditional foam
- Expansive field of vision
- Shell provides maximum ventilation

Color Options: **Black, Navy, Royal Blue, Scarlet.**1391772 OSFM (6 5/8" - 7 1/2") \$99<sup>22</sup> EA

## SCORPION CHEST PROTECTOR

- Features a permeable wide weave mesh over perforated form to maximize ventilation
- Unique back harness huge back and shoulders
- Removable and adjustable shoulder caps

Color Options: **Black, Navy, Royal Blue, Scarlet.**1391784 12" \$64<sup>22</sup> EA1391791 13" \$69<sup>22</sup> EA1391798 15" \$74<sup>22</sup> EA1391805 16" \$79<sup>22</sup> EA

## SCORPION LEG GUARDS

- Optimized hard shell coverage with perforated padding created protection and weighs 21% less than traditional leg guards
- Maximum knee and leg coverage Powered by D30 energy lock technology

Color Options: **BK/Dk. Green, Bk/Maroon, Bk/Navy, Bk/Royal, Bk/Scarlet, Black.**1391812 13" Double Knee \$74<sup>22</sup> EA1391818 14" Double Knee \$79<sup>22</sup> EA1391830 14" Triple Knee \$84<sup>22</sup> EA1391824 16" Double Knee \$84<sup>22</sup> EA1391836 16" Triple Knee \$89<sup>22</sup> EA1391842 17" Triple Knee \$94<sup>22</sup> EANEW!  
Rawlings

## VELO CATCHER'S SET

- Helmet is two toned matte with gloss finish and meets all NOCSAE standards
- Chest protector has a dynamic fitting system which provides optimal fit and automatically adjusts the protector into the proper position
- Leg guard are triple knee style, light weight vented for protection and comfort
- Age 12+ - Helmet fits 7 1/8" to 7 3/4"; chest protector is 17"; leg guards are 16.5"
- Age 9-12 - Helmet fits 6 1/2" to 7"; chest protector is 15.5"; leg guards are 15.5"
- Age 6-9 - Helmet fits 6 1/2" - 7"; chest protector is 13.5"; leg guards are 13.75"

## Black and Graphite

1391755 Age 12+ \$369<sup>22</sup> EA1391756 Age 9-12 \$349<sup>22</sup> EA1391757 Age 6-9 \$329<sup>22</sup> EA

## White and Silver

1391758 Age 12+ \$369<sup>22</sup> EA1391759 Age 9-12 \$349<sup>22</sup> EA1391760 Age 6-9 \$329<sup>22</sup> EANEW!  
No Errors

## NOE2 CATCHER'S BAG

- 9 unique pockets and compartments for storage
- Shelving system to keep equipment organized
- Holds up to (3) 34" bats
- 4 hideaway hooks
- Fat boy wheel technology

Color Options: **Black, Navy, Red, Royal.**1384017 Specify Color \$199<sup>22</sup> EALOUISVILLE  
Slugger

## SERIES 9 CATCHER'S GEAR BAG

- High rise wheel chassis
- Internal holsters for shin guards
- Extra room for chest protector and other gear
- Compression straps to keep everything in place
- Two durable J-style fence hooks

1375630 35"L x 16.5"W x 11"H

\$149<sup>22</sup> EA

## UMPIRE EQUIPMENT



### MacGregor UMPIRE ACCESSORY PACK

- Boxed set includes:
- Plate brush (MCB91XXX)
  - Ball bag (balls not included)
  - 4-way indicator

<b>MCUMPKIT</b>	Complete Pack	\$14 <sup>99</sup> PACK ★
<b>MCB94XXX</b>	Bag Only	\$7 <sup>99</sup> EA ★
<b>MCB91XXX</b>	Plate Brush Only	\$6 <sup>99</sup> EA ★



### MacGregor COMPLETE UMPIRE PACK

- Box Set includes:
- B29 Pro 100 mask (MCB29BKX)
  - MCB79 inside chest protector
  - MCB67 leg guards
  - Ball bag (balls not included)
  - Plate brush
  - 4-way indicator (BBUMPIN4)

**MCUMPSET** \$129<sup>99</sup> PACK ★

### MacGregor MCB29 PRO MASK

- Hollow tubular steel frame
- Lighter than traditional masks
- Durable vinyl coating with extended ear and throat guard
- Complete with harness

Color Options: **Black**.

**MCB29BKX** With Black Vinyl Pads \$42<sup>99</sup> EA ★



### MCB78 OUTSIDE CHEST PROTECTOR

- Filled with 3" thick lightweight foam
- Adjustable shoulder straps with vinyl neck rest
- Features a built in ball pocket

**MCB78BXX** Size: 21 1/2"L \$44<sup>99</sup> EA ★



### MCB79 INSIDE CHEST PROTECTOR

- Super light weight
- Wrap-around throat pad
- Extended upper shoulder ribs

**MCB79BXX** Size: 16.5"L \$52<sup>99</sup> EA ★



### PRO UMPIRE SHIRT

- 55% cotton/45% polyester
  - Reinforced front pocket
  - Rib knit collar and cuffs
- Size: **MED, LRG, XLG.**

<b>CUMPRO</b>	Navy - MD-XL	\$37 <sup>99</sup> EA ★
<b>CUMPROXX</b>	Navy - XXL	\$38 <sup>99</sup> EA ★
<b>CUMPROXXX</b>	Navy - XXXL	\$39 <sup>99</sup> EA ★
<b>LBUMP</b>	Lt Blue - MD-XL	\$36 <sup>99</sup> EA ★
<b>LBUMPXXL</b>	Lt Blue - XXL	\$38 <sup>99</sup> EA ★
<b>LBUMPXXX</b>	Lt Blue - XXXL	\$39 <sup>99</sup> EA ★

## Diamond

### DFM-iX3 UMPIRE FACE MASK

- Lightweight single bar design
  - Extended upper U-bar to protect from foul balls
  - Low profile design
- Color Options: **Black, Silver.**

I291483 Specify color \$69<sup>99</sup> EA



### DCP-iX3 UMPIRE CHEST PROTECTOR

- Lightweight iX3 breathable technology
- CoolMax fabric for moisture management
- Adjustable arm pads
- Removable sizing plate included

I291506

14" L w/o sizing plate; 18.5" w/ plate

\$79<sup>99</sup> EA



### MacGregor MCB67 UMPIRE'S LEG GUARDS

- Molded ABS construction
- Durable close-cell foam
- Fully padded ankle and instep
- 12" shin plate

**MCB67XXX** Black only \$39<sup>99</sup> PR ★

### MacGregor UMP'S INDICATOR

- Records balls, strikes, outs

<b>BBUMPIND</b>	Plastic	\$5 <sup>99</sup> EA ★
<b>BBUMPSTL</b>	Steel	\$6 <sup>99</sup> EA ★

### 4 WAY UMPIRES INDICATOR

- Plastic indicator
- Records balls, strikes, outs and innings.

**BBUMPIN4** \$4<sup>99</sup> EA ★



### SHORT BILL UMPIRE CAP

- Polywool umpires cap with 1-1/2" short bill
- Adjustable hook/loop back
- Navy only

**BBUCSBNV** Fits sizes 6 7/8" - 7 1/4" \$9<sup>99</sup> EA

### DLG-iX3 UMPIRE LEG GUARDS

- Vented iX3 padding
  - Floating middle knee
  - Locking J-hooks
  - Removable toe extension
- Size: **15.5", 17.5", 18.5".**

I291513

Specify size \$64<sup>99</sup> PR



## Rawlings GLOVES



### PREMIUM PRO 12"

- Soft full-grain shell for game ready feel
- An innovation design to improve how the glove fits
- Lace-less heel and palm for better feel

**1380043** Fits Left Hand \$69<sup>22</sup> EA  
**1380044** Fits Right Hand \$69<sup>22</sup> EA



### PREMIUM PRO 12.5"

- Soft, full grain leather shell for game ready feel
- Heel and palm designed to provide better feel
- 1 piece palm construction helps provide ultimate control

**1380045** Fits Left Hand \$69<sup>22</sup> EA  
**1380046** Fits Right Hand \$69<sup>22</sup> EA



### PLAYER PREFERRED SOFTBALL GLOVE 13"

- Pro H web design
- Conventional with flex loop back
- Quality full grain leather
- Quick, easy break-in for game ready feel

**1380047** Fits Left Hand \$64<sup>22</sup> EA  
**1380048** Fits Right Hand \$64<sup>22</sup> EA



### PLAYER PREFERRED CATCHERS MITT 33"

- 1 piece closed web
- Conventional back
- Quality full grain leather for enhanced durability
- Quick, easy break-in for game ready feel

**1380049** Fits Left Hand \$69<sup>22</sup> EA  
**1380050** Fits Right Hand \$69<sup>22</sup> EA



### SHUTOUT FP GLOVE 12"

- Finger shift advantage for easy close
- Helps protect hand from ball impact
- Woven web design
- Adjustable non-slip pull strap back

**1385137** Fits Left Hand \$69<sup>22</sup> EA  
**1385138** Fits Right Hand \$69<sup>22</sup> EA



### SHUTOUT FP CATCHERS MITT 34"

- ProH web with base
- Adjustable non-slip pull strap back
- Custom fit

**1385139** Fits Left Hand \$74<sup>22</sup> EA  
**1385140** Fits Right Hand \$74<sup>22</sup> EA

## EASTON GLOVES



### SALVO 11.5" INFIELD GLOVE

- Woven web with open back
- VRS palm pad
- Double deep pocket design

Size: **11.5**  
 Color Options: **LHT, RHT.**

**1377562** Fits Left Hand \$69<sup>22</sup> EA  
**1377563** Fits Right Hand \$69<sup>22</sup> EA



### SALVO 12" INFIELD GLOVE

- Woven web with open back
- VRS palm pad
- Double deep pocket design

**1377564** Fits Left Hand \$69<sup>22</sup> EA  
**1377565** Fits Right Hand \$69<sup>22</sup> EA



### SYNERGY 13" FP GLOVE

- Woven web design
- Ideal Fit with modified closed back
- VRS palm pad

**1377570** Fits Left Hand \$59<sup>22</sup> EA  
**1377571** Fits Right Hand \$59<sup>22</sup> EA



### SYNERGY FP 33" CATCHER'S MITT

- Welled split solid web
- Ideal Fit closed back design
- VRS palm pad

**1377572** Fits Left Hand \$59<sup>22</sup> EA  
**1377573** Fits Right Hand \$59<sup>22</sup> EA

## MIZUNO GLOVES



### GX 34" FP CATCHERS MITT

- Built for superior feel and easier break-in
- PowerLock closure for maximum performance
- V-Flex notch to help initiate easy closure

**1385193** Fits Left Hand \$74<sup>22</sup> EA  
**1385194** Fits Right Hand \$74<sup>22</sup> EA

## MacGregor® GLOVES & MITTS



### 12" SCHOLASTIC FIELDER'S GLOVE

- Leather palm and webbing
- Synthetic backing
- Adjustable wrist strap
- Ideal for baseball and softball

**BBBGVARX** Fits Left Hand \$32.22 EA ★  
**BBBGVARR** Fits Right Hand \$32.22 EA ★



### 12.5" VARSITY FIELDER'S GLOVE

- Pre-oiled leather construction
- Open web design
- Quick and easy break in
- Ideal for infield or outfield

**MCFG125X** Fits Left Hand \$49.22 EA ★  
**MCFG125R** Fits Right Hand \$49.22 EA ★



### 12.5" YOUTH FIELDER'S GLOVE

- Leather palm and webbing
- Synthetic backing
- Adjustable wrist strap
- Open web design

**BBMESHXX** Fits Left Hand \$29.22 EA ★  
**BBMESHXX** Fits Right Hand \$29.22 EA ★



### 13.5" FIELDER'S GLOVE

- Selected cowhide palm and back
- Leather lining and lacing
- Finger hole & adjustable strap
- Open web design

**BBFSPROX** Fits Left Hand \$57.22 EA ★  
**BBFSPROR** Fits Right Hand \$57.22 EA ★

## FAST PITCH

## FIRST BASE



### 34" FASTPITCH CATCHER'S MITT

- Pre-oiled full grain leather w/ rawhide lacing
- Pre-formed for easy break-in
- Large softball pattern with dual "H" post web design
- Exclusive PROLOCK hook-and-loop fastener wrist closure

**MCCM300X** Fits Left Hand \$69.22 EA ★



### 12.5" 1ST BASE MITT

- All leather construction
- Pre-oiled for short break-in period
- Top quality first base mitt for youth through high school

**MCFB100X** Fits Left Hand \$57.22 EA ★  
**MCFB100R** Fits Right Hand \$57.22 EA ★



### 10.5" TEE BALL GLOVE

- Soft synthetic leather construction for easy break in
- Rawhide lacing for added durability
- Adjustable wrist strap
- Ideal for t-ball and youth baseball.

**BBFGTBXX** Fits Left Hand \$19.22 EA ★  
**BBFGTBRX** Fits Right Hand \$19.22 EA ★



### 12" VARSITY FIELDER'S GLOVE

- Leather construction
- Pre-oiled for quick break in
- Closed web design

**BBFGPROX** Fits Left Hand \$52.22 EA ★

## MacGregor® CATCHER'S MITTS



### 33.5" VARSITY CATCHER'S MITT

- High grade pre-oiled leather
- Exclusive major league design
- Ideal for varsity to adult players

**MCCM200X** Fits Left Hand \$74.22 EA ★



### 33" PREP CATCHER'S MITT

- Top quality pre-oiled leather
- Scoop toe design
- Deep grip pocket
- Ideal for ages 12-15

**MCCM100X** Brown - Fits Left Hand \$59.22 EA ★  
**MCCM101X** Black - Fits Left Hand \$59.22 EA ★



### 32" YOUTH CATCHER'S MITT

- Full grain leather
- Pre-oiled for easy break in
- Deep pocket and scoop toe design
- Ideal for ages 9-12.

**BBCMPROX** Fits Left Hand \$59.22 EA ★  
**BBCMPROR** Fits Right Hand \$59.22 EA ★



### 29" JUNIOR CATCHER'S MITT

- Full grain leather
- Pre-oiled for easy break in
- Deep pocket and scoop toe design
- Ideal for ages 5-8.

**BBCMLLXX** Fits Left Hand \$49.22 EA ★  
**BBCMLLFR** Fits Right Hand \$49.22 EA ★

**GLOVES**
**125 SERIES GLOVE 11.5"**

- Modified trapezoid webbing design
- Open back design
- Superior feel and easy break in

**1385182** Fits Left Hand \$69<sup>22</sup> EA  
**1385183** Fits Right Hand \$69<sup>22</sup> EA

**125 SERIES CATCHERS MITT 32.5"**

- Built for superior feel and easier break-in
- Open backing with velcro strap
- Used for both baseball and Slow Pitch softball

**1385184** Fits Left Hand \$64<sup>22</sup> EA

**ZEPHYR FAST PITCH CATCHERS MITT 32.5"**

- Game ready off the shelf
- Designed specifically for the female player
- Open backing with velcro strap

**1385185** Fits Left Hand \$59<sup>22</sup> EA

**NEW!**  
**XENO FAST PITCH CATCHERS MITT 33"**

- Best-in-class premium leather with soft linings
- Game ready off the shelf
- Designed for specifically for the female player

1391263 Fits Left Hand \$89<sup>22</sup> EA  
 1391264 Fits Right Hand \$89<sup>22</sup> EA

**TUNNEL NETS****BEST SELLER****MacGregor**  
**INFIELD TRAINING GLOVE**

- "Pancake" style glove is ideal for infield training
- Aids in developing a quick "glove to throw" transition
- Leather construction

**1281491** Fits on left hand \$27<sup>22</sup> EA ★

**Wilson GLOVES****A500 GLOVE 11"**

- Lightest all leather glove on the market
- Flexible and ready for play today
- Double palm construction keeps the pocket stable

**1385207** Fits Left Hand \$54<sup>22</sup> EA  
**1385208** Fits Right Hand \$54<sup>22</sup> EA

**NEW!**  
**A360 13" SLOW PITCH GLOVE**

- Perfect all position slow pitch glove
- Leather palm and web
- Aso webbing

**1298598** Fits Left Hand \$38<sup>22</sup> EA

**NEW!**  
**A360 14" GLOVE**

- Split hinge web design
- Leather palm and web
- Designed for slow pitch players who prefer a larger glove

**1385394** Fits Left Hand \$39<sup>22</sup> EA  
**1385395** Fits Right Hand \$39<sup>22</sup> EA

**A360 CATCHERS MITT 31.5"**

- Half moon design
- Youth pattern design

**1385206** Fits Left Hand \$37<sup>22</sup> EA

**SOFTHANDS INFIELD TRAINER**

- Durable foam infield training tool for developing quick hands while fielding ground balls or completing a double play.
- Officially approved and licensed by Little League® Baseball.

**BBSOFTLL** Youth Model \$23<sup>22</sup> EA  
**BBSOFTPR** Professional Model \$23<sup>22</sup> EA

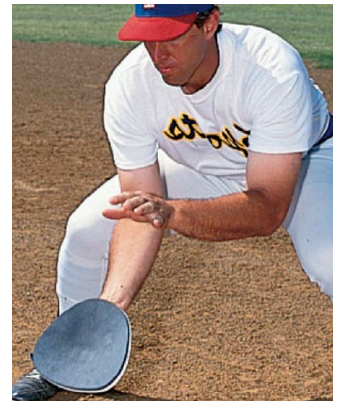





### STRIKE ZONE

- Heavy duty design clamps to posts 2-1/2" to 4"D
- Creates great warm-up/hitting station.

I274183	Baseball	\$169 <sup>99</sup> EA
I274190	Softball	\$169 <sup>99</sup> EA
I274806	Extra ball/rope(Specify Baseball or Softball)	\$38 <sup>99</sup> EA



### ACCUBAT<sup>™</sup> PRO MODEL

- Advanced tool lets coaches place grounders, flyballs, and line drives with pinpoint accuracy
- Made of graphite composites as professional rackets
- Treated torsion bands propel baseballs or softballs with speed and accuracy
- Perimeter weighted design
- Non-slip grip

<b>BBACCBAT</b>	26oz Pro Model	\$87 <sup>99</sup> EA
-----------------	----------------	-----------------------



### schutt

#### SLIDE RITE

- The only training aid you need to teach perfect sliding techniques
- The patented design features a durable cordura cushioned mat and canvas sliding sheet to help take the fear out of sliding.

1037029	Standard Size (42"W X 12'L)	\$339 <sup>99</sup> EA
---------	-----------------------------	------------------------

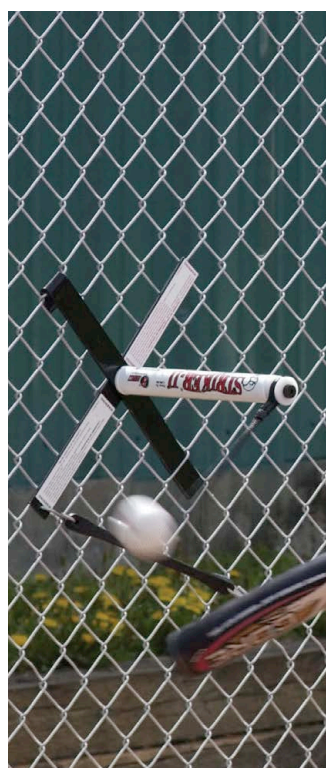

### schutt

#### STRIKER II HITTING TRAINER

- The perfect warm up/training device for baseball or softball.
- Comes with a 9" safety baseball that won't harm aluminum bats
- Designed to quickly attach to any chain link fence
- Fits easily into a player's bag.

<b>STRIKER2</b>	Complete Unit	\$77 <sup>99</sup> EA
-----------------	---------------	-----------------------



#### ROTORTWIN HITTING TRAINER

- Proper swing spins the "rotor" smoothly, giving instant feedback
- Durable, lightweight, portable and affordable
- Includes sandbags and instructional video.

5R0TTWMBB	\$179 <sup>99</sup> EA
-----------	------------------------



### SKLZ<sup>®</sup> Hit-A-Way<sup>®</sup>

- Simulates pitches without chasing balls
- Develops hand-eye coordination and learning to switch hit
- New sleeve design improves visibility as well as contact feel & sound
- Post not included

<b>5HITAWAYBB</b>	Baseball	\$39 <sup>99</sup> EA
<b>5HITAWAYSB</b>	Softball	\$39 <sup>99</sup> EA



#### INSTRUCTO SWING BATTING TEE

- Great for developing proper swing path to the ball
- Completely portable
- Use indoors or outdoors
- Great for developing switch hitters

<b>I373582</b>	Ultra Design	\$229 <sup>99</sup> EA
<b>I373583</b>	Replacement Tees	\$24 <sup>99</sup> EA



#### TRAINING BAT

- Excellent training bat for either one or two handed hitting drills
- Helps strengthen hands, wrist and forearms

1385179	28"	\$39 <sup>99</sup> EA
1385180	22"	\$39 <sup>99</sup> EA
1385181	18"	\$39 <sup>99</sup> EA

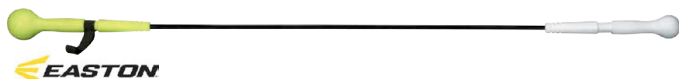

#### EASTON TRAINING STICK

- The most effective & versatile batting drill device available
- Unique design features **BOTH Baseball & Softball ends**
- 63" length ideal for both Adult & Youth players
- Flexible shaft, texturized vibration dampening handle
- Dramatically improves hitting stance, contact and bat control

<b>I264050</b>	\$49 <sup>99</sup> EA
----------------	-----------------------



#### EASTON THUNDERSTICK T10/T11

- Ideal for soft toss drills
- Can be used with plastic or regular baseballs
- Use plastic golf ball to sharpen hand-eye coordination
- 1" barrel

<b>I264005</b>	Adult T10 (33"/37oz)	\$64 <sup>99</sup> EA
<b>I264012</b>	Youth T11 (30"/26oz)	\$59 <sup>99</sup> EA

## PITCHER'S TRAINING AIDS

**PITCHING TARGET**

- Vinyl coated nylon catcher with pouch
- Two sided pitcher's target
- Will accommodate both right-handed and left-handed hitters
- Frame is 1-5/8" diameter, 18 gauge galvanized steel
- No tools required to assemble

1196849

Size - 48"W x 78"H. 30 lbs.

\$217<sup>22</sup> EA ★**NEW!****COLLEGIATE REBOUNDER SCREEN**

- Large 7' x 7' frame
- Heavy-duty 1 1/2" square, 17 gauge galvanized steel tube construction
- 2.5mm twisted knotted PE, 1.75" mesh
- Rebounder has 4 angle adjustments - 0, 10, 20 and 30 degrees - and can direct ball up into the air or onto the ground
- Can be used from either side

1378661

\$299<sup>22</sup> EA ★**ZONE IN FOR PITCHERS**

- Designed to allow you to isolate the strike zone
- Over 20 different specific pitch strategies
- Heavy duty steel frame
- Vinyl coated polyester tarp
- Quality net pockets for outstanding durability

K35662

\$219<sup>22</sup> EA**THE DESIGNATED HITTER**

- Learn to pitch inside and how to handle hitters who crowd the plate
- Two-piece for safe and easy portability.
- Available in jersey colors: Red, Blue and Gray.
- Pro model batter stands 5'9" tall.
- Youth model batter stands 5'2" tall.

1. 1323498

Pro Model

\$349<sup>22</sup> EA

2. 1323504

Youth Model

\$339<sup>22</sup> EA**schutt****STRIKE ZONE HOME PLATE**

- Great for visual focus when teaching the importance of situational pitching and hitting
- Also great for umpire training
- For use by baseball and softball players of all ages and ability
- Extended version teaches pitchers to throw to the black

1058741

Standard Version

\$18<sup>22</sup> EA

1194081

Extended Version

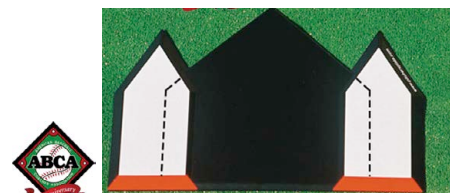
\$34<sup>22</sup> EA**THE ULTIMATE PITCHER'S & CATCHER'S PLATE™**

- The plate highlights 3.5" on and 3.5" off the plate
- Provides a great visual for pitchers and catchers
- Can be used in hitting drills (two-strike hitting, expanding the zone)
- Made of lightweight yet very durable ABS
- Weighs just under 1.6 lbs

1236552

\$64<sup>22</sup> EA

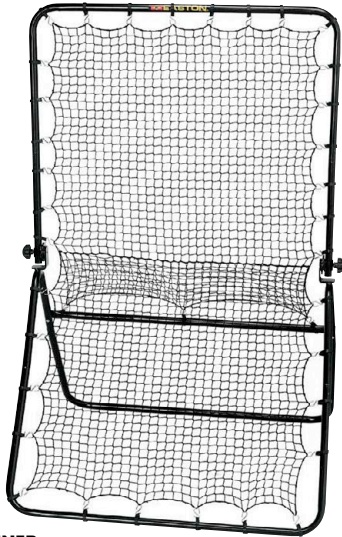

**EASTON**  
**PLAYBACK TRAINER**

- Adjustable upper bracket for increased training options
- Heavy duty weatherized netting
- No tools required
- Perfect for the youth player

20012820 Junior Size - 38" W X 58" H \$79<sup>22</sup> EA  
 20012915 Adult Size - 42" W X 72" H \$144<sup>22</sup> EA



**SOFT TOSS SCREEN**

- Features a rigged steel and fiberglass pole patented design
- Assembles in minutes
- Zero maintenance
- Free carry case included

1347203 \$139<sup>22</sup> EA



**EASTON**  
**5' POP UP MULTI NET**

- Great multi-function/multi-sport training aid
- Sets up as a catch net, goal or target
- Comes with adjustable, removable target
- Two break down poles with pole pocket and four ground stakes
- Easy set up and take down

1194883 Size - 5'H x 5'W \$139<sup>22</sup> EA



**BIG MOUTH SCREEN**

- The Big Mouth is fast and stable, easy to set up
- Handles any age group, t-ball to college kids
- Comes complete with 7' x 7' net, ground frame, 2 stakes and composite bow poles
- Included is a free zippered carry bag

1347197 \$149<sup>22</sup> EA



**ENDURO SOFT TOSS SCREEN**

- Tubular steel frame
- Slip over "pillow case" design netting
- Over-hang on top for extra protection

K35762 Size - 6' x 4' \$299<sup>22</sup> EA



**INSTANT SCREEN**

- Made of sturdy lightweight spring steel
- Folds down to a compact 36" circle
- Weighs less than 14 lbs

1159943 Size - 7'H x 8'W \$179<sup>22</sup> EA



**TRAVEL SCREEN**

- Steel base
- Sets up in less than 2 minutes
- Fits in 30" travel bag

1385408 7' Screen \$199<sup>22</sup> EA

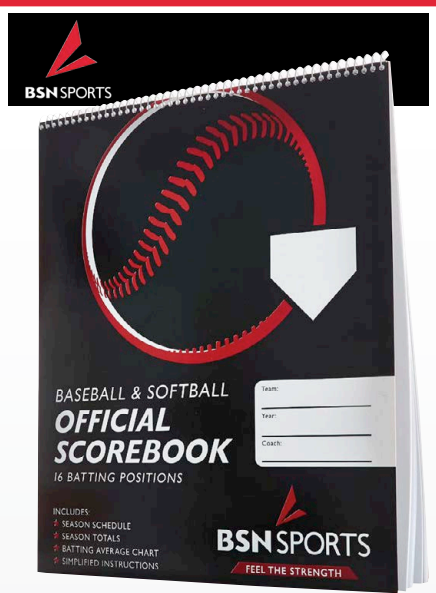

**BASEBALL/SOFTBALL SCOREBOOK**

- Ideal for baseball or softball with spiral at the top
- Each book scores 26 games with 16 batting positions and 9 innings per sheet
- Also includes team roster, season schedule, season totals, batting average chart, pitcher stats and simplified scoring instructions
- Pages measure 9-1/2" x 11"

**MSBASBOK** Standard Size \$4.22 EA

**BASEBALL/SOFTBALL SCOREBOOK OVERSIZED**

- Oversize pages (14" x 11") pages for easier scoring
- 30 game scorebook with 11 batting positions
- Also includes team roster, season schedule, season totals, batting average chart, pitch count, and simplified scoring instructions.

**MCBIGBOK** \$7.22 EA



**BASEBALL/SOFTBALL LINE-UP CARD BOOKLET**

- Four-part carbonless line-up cards
- 24 sets per booklet.
- 4 1/2" x 8 1/2"

**MCLINEUP** \$7.22 EA

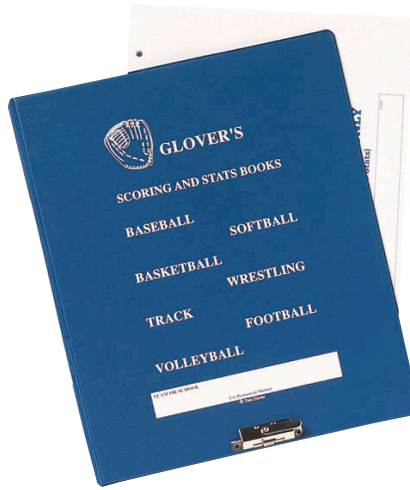

**GLOVER'S BINDER**

- Keep 24, 48, or 72 games in one binder
- Clip keeps scoresheets firmly in place
- Multiple pockets for schedules, addresses, player rosters, etc
- Scoresheets not included.

**MSGLBIND** \$29.22 EA

**GLOVER'S BASEBALL/SOFTBALL SCORING & STAT REFILLS**

- Includes simplified scoring instructions, batting average chart, 6-7-9 inning ERA chart, team summary pages, individual batting and pitching charts, and inning extenders.
- Sheets are 11" x 14.5"

**MSGLSCST** pack of 30 \$19.22 PACK

**GLOVERS BASEBALL/SOFTBALL SCORE SHEETS**

- Includes inning extenders
- Packaged for coaches who have a computer and do not need individual stat sheets
- 11 batting positions

**MSGLSCOR** pack of 50 \$23.22 PACK



**PETERSON® SCOREMASTER**

- Simplified scoring instructions
- Wire binding
- Club size 12" x 8-1/2"
- Enables complete summary of individual player records and pitching performance
- Suitable for softball as well as baseball
- Contains 25 games with 11 batting positions.

**MSPTRBOK** \$8.22 EA

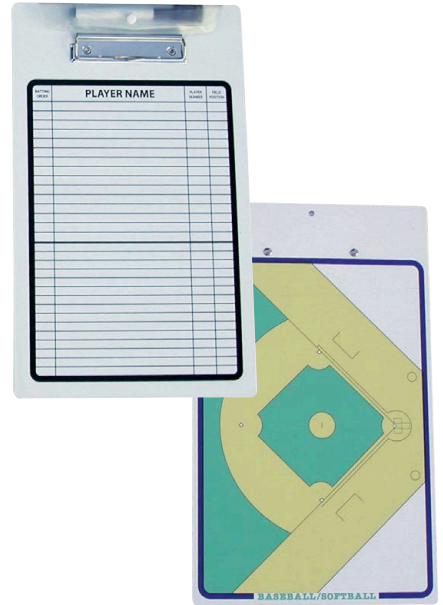

**DOUBLE SIDED COACH'S BOARD**

- 15 1/2"H x 9 1/2"W dry-erase board with diagrams
- Includes dry-erase pen with eraser head and built in storage pocket

**I235999** Board w/pen \$19.22 EA ★

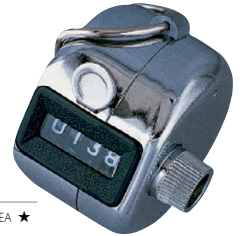

**TALLY COUNTER**

- Hand held model
- Counts up to 9999

**MSHTALLY** \$9.22 EA ★



**HOME & ROAD PITCH COUNTER**

- Dual pitch counter allows coaches to track two pitchers at once
- Sleek design fits ergonomically in hand

**I264067** Color: Black only \$16.22 EA

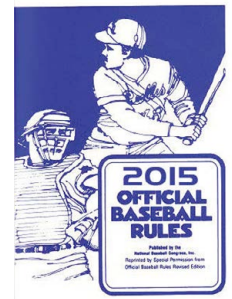

**OFFICIAL BASEBALL RULES**

- By National Baseball Congress
- Pocket sized for on-the-field use.

**I015577** \$4.22 EA



### PERMANENT BAT RACK

- Heavy-duty galvanized steel bat rack
- Holds up to 14 bats
- Permanently mounts directly to dugout surface
- Weight: 33 lbs.

**1148826** Size - 35"H x 25.5"W x 6"D \$169<sup>22</sup> EA ★



### BALL BABY

- Helps to reduce game delays
- Easily installs on any chain-link fence
- Made from heavy duty plastic

1362329 Baseball \$84<sup>22</sup> EA  
1362336 Softball \$84<sup>22</sup> EA



### DUGOUT ORGANIZER RACK

- Durable steel rack that is easily attached to cement, brick or wood dugout walls.
- Holds up to 10 batting helmets with face guards, 12 bats and includes a ball chute for 10 baseballs or 8 softballs
- Dimensions: 39"H x 48-1/4"W

1046267 Baseball Version \$229<sup>22</sup> EA   
1046274 Softball Version \$229<sup>22</sup> EA



### SURFACE MOUNTED HELMET TREE

- Easy way to store batters helmets in the dugout
- Holds 12 helmets

**BSHTS** Size - 18"W x 12"D x 70"T \$229<sup>22</sup> EA ★



### MacGregor HELMET CADDY

- Heavy-duty 600 denier polyester
- Oversized pockets
- Hangs on chain link fence or dugout
- Rolls up for easy storage and handling
- Black only

**1187038** 8 Helmet Model \$39<sup>22</sup> EA ★  
**1264029** 12 Helmet Model (pictured) \$49<sup>22</sup> EA ★

### EXPANDO HELMET RACK

- Lightweight aluminum construction
- Clips on the dugout fence
- Holds 8 batting helmets.
- When not in use, it scissor folds to fit neatly into your bag

**1159615** \$79<sup>22</sup> EA ★



### STEEL FENCE BAT RACK

- Hooks on fence to hold 10 bats
- Steel construction
- Weight 5 lbs.

**1159622** Size - 30" long \$57<sup>22</sup> EA ★



### FENCE MOUNTED BAT RACK

- Durable steel bat organizer that holds 10 bats
- Mounts and removes easily on chain link fences
- Holds bats securely in place
- Complete with mounting hooks

**1297638** \$14<sup>22</sup> EA ★

### OUTDOOR STORAGE SHEDS

- Keep your equipment dry and secure
- Durable, double-wall resin construction
- Robust doors with padlock ready handles (padlock not included)
- Shelf support to accommodate wood shelves (not included)
- Lift Gate Required

1388498 Vertical (70 1/2"H x 32 1/4"W x 26 1/2"D) \$299<sup>22</sup> EA   
1388499 Horizontal (50 1/4"H x 58"W x 31 1/2"D) \$399<sup>22</sup> EA   
1388500 Large Vertical (79"H x 56"W x 30"D) \$489<sup>22</sup> EA   
1388501 XL Vertical (81"H x 56"W x 50 1/4"D) \$669<sup>22</sup> EA



### HIGHBOY STORAGE SHED™

- Weather resistant
- Features three permanently mounted extra-deep shelves and a tall vertical storage area
- Two large doors lock to keep contents safely away (lock not included)
- Raised floor keeps contents dry

1170429 72"H x 52"W x 27"D \$459<sup>22</sup> EA



### BATTYSHACK DUG-OUT ORGANIZER

- Holds 5 softballs or 6 baseballs and up to 12 bats
- Mounted batting order chart made of dry erase material (markers not included)
- Easily mounts on any surface
- Heavy duty plastic construction
- Weight: 4 lbs.

1148954 \$86<sup>22</sup> EA



CLASSIC LOOK

**SURGE™**

Minimum order 12 caps

**PERFORMANCE AND TRADITION**

Surge combines the technology of an engineered performance fabric with the traditional look and feel of wool serge, making it the right choice for baseball purists.

Black SEC	Navy SEC	Royal SEC	Red SEC
Purple SC	White C	Orange C	Dark Green SC
Cardinal SC	Maroon SC	Gold C	Columbia Blue C
*Texas Orange C	Gray C	Kelly C	Vegas Gold C
Brown C	S - Stock E - Custom Express C - Custom		

Fitted 6 5/8 - 8 or Adjustable SM (6 1/2 - 7 1/8) or M-L (7 - 7 3/4)

\*Texas Orange not available in piping color option



PERFORMANCE MESH

**DRYVE™****TRUE PERFORMANCE MESH**

The modern, athletic look of our new Dryve mesh fits perfectly with today's performance team apparel. Breathable moisture-wicking fabric combines with our advanced ProCrown shape to bring you the coolest cap on the field.

Black SEC	Navy SEC	Royal SEC	Red SEC
Purple SC	White C	Orange C	Dark Green SC
Cardinal SC	Maroon SC	Gold C	Columbia Blue C
*Texas Orange C	Gray C	Kelly C	Vegas Gold C
S - Stock E - Custom Express C - Custom			

Fitted 6 5/8 - 8 or Adjustable SM (6 1/2 - 7 1/8) or MD-LG (7 - 7 3/4)

\*Texas Orange not available in piping color option



FLEX FIT

**PULSE™****PERFORMANCE FLEXFIT**

The original PTS cap, and leader in performance fabric with FlexFit baseball cap construction, making it the right shape and fit for today's player.

Black SEC	Navy SEC	Royal SEC	Red SEC
Purple SC	White C	Orange C	Dark Green SC
Cardinal SC	Maroon SC	Gold C	Columbia Blue C
*Texas Orange C	Gray C	Kelly C	Vegas Gold C
S - Stock E - Custom Express C - Custom			

Flex Fit XSM (6 1/2 - 6 7/8) SM - MD (7 - 7 1/4) LG - XL (7 1/4 - 7 5/8)

\*New Youth Size (6 3/8-6 5/8)

\*Texas Orange not available in piping color option



SOLID CONTRASTING COMBINATION ALTERNATE

CAP (CROWN/VISOR) +  
BUTTON + EYELETCROWN + BUTTON + EYELET +  
VISOR + PIPING

**S** STOCK  
1292923 \$18.42 EA

2 WEEKS FOR DELIVERY

**ECX** CUSTOM EXPRESS  
1292930 \$18.22 EA

2 WEEKS FOR DELIVERY

**EC** CUSTOM  
1292947 \$20.22 EA

3-4 WEEKS FOR DELIVERY

**ADDITIONAL EMBROIDERY**

1292961 \$1.82 EA

RIGHT SIDE OR BACK





















**PIPING**

1292954 \$1.82 EA

**SANDWICH VISOR**

1282399 \$1.00 EA



-  A Gold
-  Gold
-  Optic White
-  College White
-  Orange
-  H Red
-  Scarlet
-  Cardinal
-  Maroon
-  Walnut
-  Purple
-  Navy
-  Light Navy
-  Dark Royal
-  Light Royal
-  Sky Blue
-  Dark Green
-  Kelly Green
-  Black
-  Dark Graphite
-  Gray
-  Rust (Texas Orange)
-  Vegas Gold



# CUSTOM TEAM CAPS

Your colors. Your design. No set-up fees!

## PERFORMANCE FABRIC CAP

### 1. CHOOSE CAP COLOR

- Over 18 team colors to choose from (8-10 weeks)
- Choose from 11 stock solid colors for 3-4 week delivery

### 2. CHOOSE A LOGO

- Is your design 1-3 letters?
- Is it a mascot or other design?
- Use our designs or yours

### 3. CHOOSE SIZES

- Fitted Custom 6 3/8 thru 8 1/2
- Fitted Stock 6 7/8 thru 8
- Adjustable (Perfect for boosters & parents...custom only)



- Original 5950 • Official cap of MLB • Original Fitted
- Custom caps in 8-10 weeks • Stock caps in 3-4 weeks



**BACK & RIGHT EMBROIDERY**    **PIPING FOR CUSTOM CAPS**

1217209    \$2.22 EA    1217339    \$1.02 EA

\$19.99

**CUSTOM 5950 WITH EMBROIDERY**

NE59PERL    Performance    \$19.22 EA    **Minimum order 24 caps**



## CHOOSE A STOCK COLOR FOR FASTER DELIVERY!

Stock 5950s are Classic Wool Caps available in 11 Solid colors.

-  Maroon
-  Purple
-  Light Royal
-  Gray
-  Scarlet
-  Navy
-  Dark Green
-  Black
-  Cardinal
-  Light Navy
-  Kelly

### STOCK CAP PRICING

1217193    With Logos    \$18.22 EA

- All stock caps are High Crown
- Available in sizes 6 7/8 thru 8

**Put your logo on a stock cap...it ships in 3-4 weeks!**    **Minimum order 24 caps**



### SEMESTER

- 39THIRTY, unifit sweatband
- Cotton twill visor and front
- White spacer mesh mid & rear panels
- Sizes: S/M, M/L

Color Options: **Black, Cardinal, Dark Royal, Maroon, Navy, Pink, Purple, Royal, Rust Orange, Scarlet, Sky Blue, White.**

NE39SL    With Embroidery    \$17.22 EA



### 3930 NEO

- 39THIRTY, unifit sweatband
- Cotton twill visor and front
- Colored spacer mesh mid & rear panels
- Sizes: S/M, M/L

Color Options: **Black, Cardinal, Dark Green, Kelly Green, Maroon, Navy, Royal, Rust Orange, Scarlet, White.**

NE39NL    With Embroidery    \$17.22 EA



### 3930 STRETCH POLY

- Low profile cap style
- 97% wool/3% spandex
- Closed back, unifit sweatband
- Sizes: S/M, M/L

Color Options: **Black, Cardinal, Dark Green, Grey, Kelly, Lt Navy, Maroon, Navy, Purple, Royal, Scarlet, Sky Blue.**

NE39L    With Embroidery    \$17.42 EA



Black Grey White



Set-In Rear Pockets



### ELASTIC WAIST BASEBALL PANT

- 100% polyester with tapered legs
- Closed front with full 2-1/4" elastic waist band with hidden draw cord
- Set-in back pocket(l)
- Double knee construction

<b>AALLBDK2</b>	Youth XXS-XL	\$6 <sup>22</sup> EA
<b>AA604PDK2</b>	Adult S-XXL	\$11 <sup>22</sup> EA



Black Grey White



### BELTED WAIST BASEBALL PANT

- 100% Polyester double knit, double knee
- 2-1/2" non-roll elastic waistband with two snap closures
- Pro-style tunnel pant loops
- Zipper front and back pocket

Sizes: S (20-22), M (24-26), L (28-30), XL (32-34)

<b>AA605PY</b>	Youth S-XL	\$10 <sup>22</sup> EA
<b>AA605P</b>	Adult S-XL	\$13 <sup>22</sup> EA



### OPEN BOTTOM BASEBALL PANT WITH PIPING

- 100% double-knit 12oz polyester
- Relaxed fit, wide leg, open bottom pant
- 3/16" piping down both sides of pants
- Double-knee, set-in back pockets with Pro-Style belt loops
- 2.5" elastic waistband, hemmed leg bottoms
- Youth inseams: XS(23.5"), S(24"), M(25.5"), L(27"), XL(28.5")
- Adult inseams: S(31"), M(32"), L(33"), XL(34"), XXL(35")

1307603	Youth S-XL	\$17 <sup>22</sup> EA
1307610	Adult S-XL	\$21 <sup>22</sup> EA
1307627	Adult XXL	\$24 <sup>22</sup> EA



Grey White



### OPEN BOTTOM BASEBALL PANT

- 100% double-knit 12oz polyester
- Relaxed fit, wide leg, open bottom pant
- Double-knee, set-in back pockets with Pro-Style belt loops
- 2.5" elastic waistband, hemmed leg bottoms
- Youth inseams: XS(23.5"), S(24"), M(25.5"), L(27"), XL(28.5")
- Adult inseams: S(31"), M(32"), L(33"), XL(34"), XXL(35")

1307634	Youth XS-XL	\$15 <sup>22</sup> EA
<b>1307733</b>	Adult S-XL	\$16 <sup>22</sup> EA
<b>1307771</b>	Adult XXL	\$18 <sup>22</sup> EA



### BASEBALL-SOFTBALL BELTS

- Elastic baseball belt with matching leather tabs
- Nickel plated buckle
- Adjustable belt fits waist sizes 22"-46"
- 1-1/2" width belt

<b>1172577</b>	\$5 <sup>22</sup> EA ★
----------------	------------------------



### ALL-SPORT ONE COLOR SOCKS

- All Purpose Sock
- 85% Acrylic, 10% Nylon, 5% Lycra Spandex
- Colors: Black, Cardinal, Dark Green, Gold, Kelly, Maroon, Navy, Orange, Purple, Royal, Scarlet, White.

<b>C20J</b>	Junior (SM)	\$38 <sup>22</sup> DZN
<b>C20Y</b>	Youth (MD)	\$39 <sup>22</sup> DZN
<b>C20V</b>	Varsity (LG)	\$40 <sup>22</sup> DZN



### ONE COLOR BASEBALL SOCKS

- Heel and toe style
- 81% acrylic/18% nylon/1% spandex
- Colors: Black, Dk Green, Navy, Royal, Scarlet

<b>C17T</b>	Junior (SM)	\$42 <sup>22</sup> DZN
<b>C17Y</b>	Youth MD	\$43 <sup>22</sup> DZN
<b>C17V</b>	Varsity (LG)	\$45 <sup>22</sup> DZN



### TWO-IN-ONE STIRRUP SOCKS

- Stirrup and sock all in one
- 80% cotton/20% nylon
- Colors: Black, Dk Green, Lt Gold, Kelly, Navy, Orange, Purple, Royal, Scarlet, Maroon

<b>C12T</b>	Junior (SM)	\$34 <sup>22</sup> DZN
<b>C12Y</b>	Youth MD	\$35 <sup>22</sup> DZN
<b>C12V</b>	Varsity (LG)	\$37 <sup>22</sup> DZN



### SOCK SIZE CHART

Sizes	Junior	Youth	Varsity
Sock Size	7-9	9-11	10-13
Shoe Size	1-5	5-9	9-13





## MOCK MESH JERSEY

- 100% eXtreme mock mesh Cationic polyester with moisture management fibers
- 2-button henley with raglan shoulder shoulders and contrasting color
- Straight hemmed bottom
- Colors: Charcoal/Electric Yellow, Charcoal/Black, Charcoal/Dk Green, Charcoal/Maroon, Charcoal/Navy, Charcoal/Purple, Charcoal/Royal, Charcoal/Scarlet, Charcoal/White

AA525Y Youth S-XL \$16<sup>22</sup> EA  
AA525 Adult S-3XL \$18<sup>22</sup> EA



## FULL BUTTON MESH JERSEY

- 100% eXtreme dura light mesh Cationic polyester
- Six button front(spaced for lettering)
- Set-in sleeves, scoop hemmed bottom
- Lightweight, soft hand small hole mesh with excellent breathability
- Colors: Black, Dk Green, Grey, Navy, Purple, Royal, Scarlet, White

AA52MBFJ Youth S-XL \$17<sup>22</sup> EA  
AA52MBJ Adult S-3XL \$19<sup>22</sup> EA



## BASEBALL JERSEY WITH BRAID

- 100% eXtreme mock mesh polyester with moisture management fibers
- Single row, white 3/16" soutache on front, neck, sleeves
- Six-button front(spaced for lettering)
- Set-in short sleeves
- Colors: Black/White, Dk Green/White, Maroon/White, Navy/White, Purple/White, Royal/White, Scarlet/White

AAPROFJB Adult S-3XL \$22<sup>22</sup> EA  
AAPROFJB Youth S-XL \$19<sup>22</sup> EA



## BASEBALL VEST WITH BRAID

- 100% eXtreme mock mesh polyester with moisture management fibers
- Single row, white 3/16" soutache on front, neck, sleeves
- Six-button front(spaced for lettering)
- Sleeveless vest construction
- Colors: Black/White, Dk Green/White, Maroon/White, Navy/White, Purple/White, Royal/White, Scarlet/White

AAPROFVB Youth S-XL \$18<sup>22</sup> EA  
AAPROFVB Adult S-3XL \$21<sup>22</sup> EA



## SOFTBALL



## WOMEN'S FASTPITCH JERSEY

- 100% eXtreme mock mesh moisture management fibers
- Solid faux front jersey-2 functioning buttons on front
- Six button front(spaced for lettering)
- Lycra mesh underarm gussets for comfort, mobility
- Scoop bottom, hemmed finish
- Colors: Black, Navy, Royal, Scarlet, White

AAPROFJW XS-2XL \$18<sup>22</sup> EA



## WOMEN'S FASTPITCH JERSEY

- 100% eXtreme microfiber moisture management jersey
- Set-in short sleeve t-shirt
- Self-material crossover crew neck
- Women's cut
- Colors: Army Green, Black, Charcoal, Col Blue, Dk Green, Electric Yellow, Flour, Orange, Maroon, Navy, Orange, Pink, Purple, Royal, Scarlet, White

AA506W XS-2XL \$9<sup>22</sup> EA



## WOMEN'S FASTPITCH PANT

- 100% double knit 12 oz polyester
- Low rise women's cut with mid-calf length
- Six pro style belt loops
- 2" elastic waistband with zipper fly two snap closure
- Colors: Black, Grey, Navy, Royal, Scarlet, White

AA605PBWY Girls S-L \$14<sup>22</sup> EA  
AA605PBW Women's XS-2XL \$15<sup>22</sup> EA

## WOMEN'S FASTPITCH PANT

- 100% double knit polyester 12 oz
- Low rise womens cut with mid-calf length
- 2" elastic waistband with drawcord for perfect fit
- Zipper fly with two snap closure
- Colors: Black, Grey, Navy, Royal, Scarlet, White

AA605PLWY Girls S-L \$14<sup>22</sup> EA  
AA605PLW Womens XS-2XL \$16<sup>22</sup> EA



**NEW!**

Available 9/15/15

**MLB® EVOLUTION T**

- 100% polyester short sleeve jersey crewneck synthetic tee
- Developed with super lightweight polyester for breathability and moisture management
- Screenprinted team logo or wordmark

**MJGYOITLJ**  
**MJGOOITLJ**

Youth S-L \$18.22 EA  
Adult S-2XL \$19.22 EA



**NEW!**

Available 9/15/15

**COOPERSTOWN EVOLUTION T**

- 100% polyester short sleeve jersey crewneck synthetic tee
- Developed with super lightweight polyester for breathability and moisture management
- Screenprinted team logo or wordmark

**MJGYOITLM**  
**MJGOOITLM**

Youth S-L \$18.22 EA  
Adult S-2XL \$19.22 EA

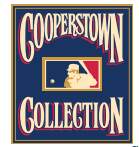



**NEW!**

Available 9/15/15

**MLB® EAGLE 2-BUTTON COLORBLOCK JERSEY**

- 100% polyester short sleeve 2-button placket jersey
- Closed hole mesh with moisture wicking
- Contrast fabric color blocking. Curved bottom hem
- Screenprinted team logo or wordmark

MJIY83TLK	Youth S-L	\$21 <sup>99</sup> EA
MJI383TLK	Adult S-2XL	\$23 <sup>99</sup> EA

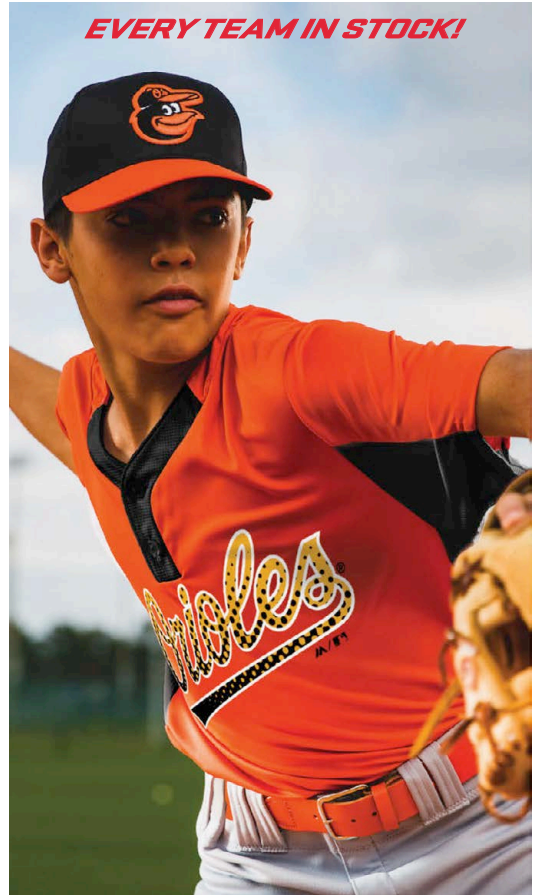

BASEBALL/SOFTBALL



**MLB CREW REPLICA JERSEY**

- 100% cotton crew neck jersey
- Official, screened team name and logo
- Full athletic chest cut
- Straight hemmed bottom
- In-Stock for quick delivery

MLBRY	Youth S-L	\$11 <sup>49</sup> EA
MLBRA	Adult S-XL	\$12 <sup>49</sup> EA
MLBRAXXL	Adult XXL	\$13 <sup>49</sup> EA

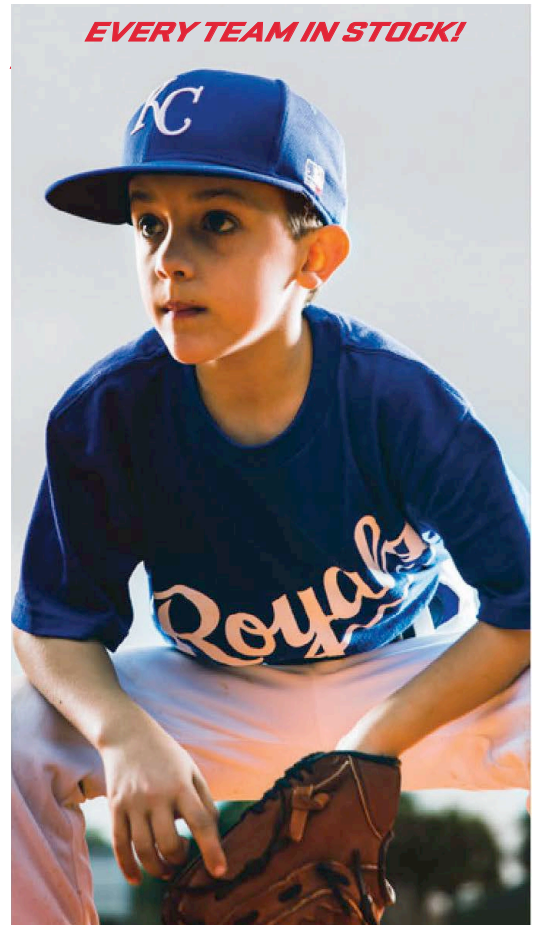



**MAJOR LEAGUE® REPLICA VISORS BY OUTDOOR CAP®**

- Cotton twill construction
- Adjustable tab back
- One size fits all

**MLBV** \$7.22 EA



**MAJOR LEAGUE® REPLICA CAPS BY OUTDOOR CAP®**

- Features 3D logo, cotton twill construction, & adjustable tab back

**MLB300Y** Youth: (6 5/8-7 1/4) \$7.22 EA  
**MLB300A** Adult: (6-7/8-7 1/2) \$7.22 EA



**MLB "COOPERSTOWN" REPLICA CAPS**

- Authentic "Cooperstown" replica logos
- 6 panel polyester/cotton twill, mid-profile design
- TEAM MLB logo on left temple
- Pre-curved visor, adjustable hook/loop tape closure

**MLBCOOPY** Youth: (6 5/8-7 1/4) \$7.22 EA  
**MLBCOOPA** Adult: (6-7/8-7 1/2) \$7.22 EA



## MINOR LEAGUE REPLICAS



### MINOR LEAGUE REPLICA T-SHIRTS

- 100% cotton jersey knit
- Screen printed with Authentic Team font or logo
- In-stock for quick delivery
- Jersey numbering available

<b>MINY</b>	Youth S-L	\$11.99 EA
<b>MINA</b>	Adult S-XL	\$12.99 EA



BASEBALL/SOFTBALL

### MINOR LEAGUE REPLICA CAPS

- Authentic Minor League Replica logos
- 6 panel, mid-profile, cotton twill
- Pre-curved visor
- Adjustable tab back

<b>MINCAPY</b>	Youth (6-5/8 to 7-1/4)	\$7.99 EA
<b>MINCAPA</b>	Adult (6-7/8 to 7-1/2)	\$7.99 EA

TIMBER RATTLERS



RIVER BANDITS





**BEST SELLER**

**SPALDING**

**NFHS**  
APPROVED

**TF-1000 CLASSIC**

- Exclusive ZK™ microfiber composite
- Wide channel design
- Indoor use only

<b>1336016</b>	Official Size (29.5")	\$54 <sup>22</sup> EA
<b>1336023</b>	Intermediate Size (28.5")	\$54 <sup>22</sup> EA

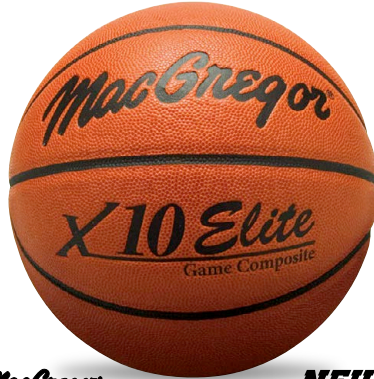

**MacGregor**

**NFHS**  
APPROVED

**X10 ELITE**

- Game microfiber composite construction
- Pebbled rubber wide channel design
- Indoor use only

**2 Year Limited Warranty**

<b>1276572</b>	Official Size (29.5")	\$49 <sup>22</sup> EA ★
<b>1276589</b>	Intermediate Size (28.5")	\$49 <sup>22</sup> EA ★



**SPALDING**

**NFHS**  
APPROVED

**TF-1000 LEGACY**

- Exclusive ZK™ composite construction
- Optimized deep channel design
- Indoor use only

<b>1335552</b>	Official Size (29.5")	\$64 <sup>22</sup> EA
<b>1335569</b>	Intermediate Size (28.5")	\$64 <sup>22</sup> EA



**BEST SELLER**

**Wilson**  
**EVOLUTION**

**NFHS**  
APPROVED

- HD pebbled microfiber composite construction
- Wide channel design
- Cushion core technology for softer feel
- Indoor use only

**3 Year Limited Warranty**

<b>1013900</b>	Official Size (29.5")	\$59 <sup>22</sup> EA
<b>1013917</b>	Intermediate Size (28.5")	\$59 <sup>22</sup> EA



**Wilson**  
**WAVE**

**NFHS**  
APPROVED

- Moisture absorbing composite construction
- Pebbled composite channels
- Cushion core technology™
- Indoor use only

<b>1235241</b>	Official Size	\$69 <sup>22</sup> EA
<b>1235258</b>	Intermediate 28.5"	\$69 <sup>22</sup> EA



**Wilson**

**NFHS**  
APPROVED

**NCAA OFFICIAL GAME BALL**

- Advanced composite cover absorbs perspiration and provides enhanced feel
- Aqua-grip channel design enhances grip
- Indoor use only

**3 Year Limited Warranty**

<b>1B0700R</b>	Official Size (29.5")	\$69 <sup>22</sup> EA
<b>1B0701R</b>	Intermediate Size (28.5")	\$69 <sup>22</sup> EA



**NFHS**  
APPROVED

**ELITE CHAMPIONSHIP AIRLOCK**

- Game-Dry composite leather
- Shooter-preferred wide channels
- Soft-touch woven microfiber backing
- Indoor use only

<b>1292039</b>	Official Size (29.5")	\$64 <sup>22</sup> EA
<b>1292046</b>	Intermediate Size (28.5")	\$64 <sup>22</sup> EA



**Baden**  
PASSION FOR A BETTER GAME

**NFHS**  
APPROVED

**PERFECTION ELITE**

- Perfection™ series ultra microfiber composite construction
- Wide channel design
- Cushion control technology™
- Indoor use only

<b>1139594</b>	Official Size (29.5")	\$69 <sup>22</sup> EA
<b>1139600</b>	Intermediate Size (28.5")	\$69 <sup>22</sup> EA



**Baden**  
PASSION FOR A BETTER GAME

**NFHS**  
APPROVED

**ELEMENT COMPOSITE**

- Perfection™ series deluxe composite construction
- Wide channel design
- Cushion control technology™
- Indoor use only

**3 Year Limited Warranty**

<b>1139617</b>	Official Size (29.5")	\$59 <sup>22</sup> EA
<b>1139624</b>	Intermediate Size (28.5")	\$59 <sup>22</sup> EA



**MacGregor X100**



- Microfiber composite construction
- Wide channel design
- Indoor use only

**2 Year Limited Warranty**

<b>MCX100XH</b>	Official Size (29.5")	\$30 <sup>22</sup> EA ★
<b>MCX128XH</b>	Intermediate Size (28.5")	\$30 <sup>22</sup> EA ★

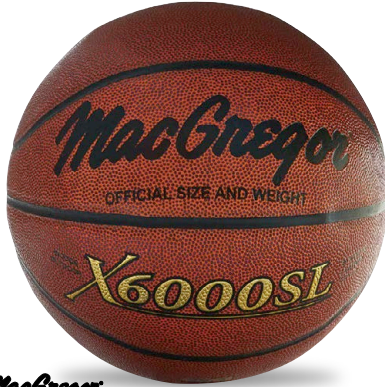

**MacGregor X6000SL**

- Synthetic construction
- Wide channel design
- Indoor/Outdoor use

<b>I297140</b>	Official Size (29.5")	\$19 <sup>22</sup> EA ★
<b>I297157</b>	Intermediate Size (28.5")	\$19 <sup>22</sup> EA ★

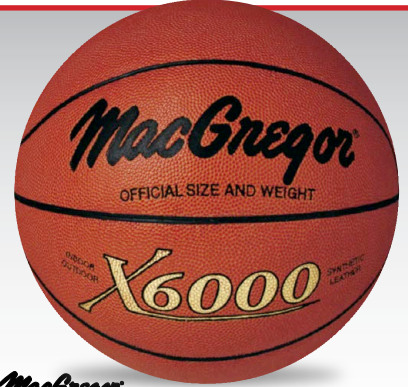

**MacGregor X6000**



- Leather feel at half the price
  - Durable composite construction
  - Wide channel design
  - Indoor/Outdoor use
- 2 Year Limited Warranty**

<b>MCX6000X</b>	Official Size (29.5")	\$24 <sup>22</sup> EA ★
<b>MCX6285X</b>	Intermediate Size (28.5")	\$24 <sup>22</sup> EA ★
<b>MCX6275X</b>	Junior Size (27.5")	\$24 <sup>22</sup> EA ★



**NEW!**

**VERS A TACK**

- High performance composite leather
- Super tacky grip and deep pebbling
- Indoor/Outdoor use

<b>I366482</b>	Official Size (29.5")	\$24 <sup>22</sup> EA
<b>I366483</b>	Intermediate Size (28.5")	\$24 <sup>22</sup> EA
<b>I366484</b>	Junior Size (27.5")	\$24 <sup>22</sup> EA



- UA exclusive gripskin microfiber composite
- Deep channel design
- Indoor/Outdoor use

<b>I367616</b>	Official Size (29.5")	\$29 <sup>22</sup> EA
<b>I367617</b>	Intermediate Size (28.5")	\$29 <sup>22</sup> EA



**SPALDING TF-500**

- Composite leather construction
- Soft feel and great grip
- Indoor/Outdoor use

<b>LBTF500M</b>	Official Size (29.5")	\$32 <sup>22</sup> EA
<b>LBTF500W</b>	Intermediate Size (28.5")	\$32 <sup>22</sup> EA



**Wilson JET COMPETITION**

- High-performance composite leather
- Pebbled composite channels
- Cushion core technology
- Indoor use only

<b>I366521</b>	Official Size (29.5")	\$46 <sup>22</sup> EA
<b>I366528</b>	Intermediate Size (28.5")	\$46 <sup>22</sup> EA



**Wilson NCAA COMPOSITE**

- Dual tone composite construction
- Pebbled rubber wide channel design
- Indoor/Outdoor use

<b>I366479</b>	Official Size (29.5")	\$29 <sup>22</sup> EA
<b>I366480</b>	Intermediate Size (28.5")	\$29 <sup>22</sup> EA



**SPALDING TF PREMIER**

- Top quality composite cover
- Wide channel design
- Indoor/Outdoor use

<b>I376603</b>	Official Size (29.5")	\$25 <sup>22</sup> EA
<b>I376604</b>	Intermediate Size (28.5")	\$25 <sup>22</sup> EA
<b>I376605</b>	Junior Size (27.5")	\$25 <sup>22</sup> EA

**RUBBER BASKETBALL**



**Voit  
ENDURO**

- Durable rubber construction
  - Recreational play
  - Indoor/outdoor use
- 2 Year Limited Warranty**

<b>VCB2HXXX</b>	Official Size (29.5")	\$11.42 EA ★
<b>VCB8HXXX</b>	Intermediate Size (28.5")	\$11.42 EA ★
<b>VCB6HXXX</b>	Junior Size (27.5")	\$11.42 EA ★
<b>VCB5HXXX</b>	Rookie Size (25.5")	\$11.42 EA ★



**RUBBER BASKETBALLS**

- Durable rubber construction
  - Wide channel design
  - Indoor/Outdoor use
- 2 Year Limited Warranty**

<b>MCX35WID</b>	Official Size (29.5")	\$9.22 EA ★
<b>MCX500XX</b>	Intermediate Size (28.5")	\$9.22 EA ★
<b>MCX2500X</b>	Junior Size (27.5")	\$9.22 EA ★

**Voit  
XB 20 THE GRIP**

- 2 ply cushioned cover provides superior feel
  - Super tack finish for increased ball control
  - Indoor/Outdoor use
- 2 Year Limited Warranty**



<b>VXB20HXX</b>	Official Size (29.5")	\$15.22 EA ★
<b>VXB20INT</b>	Intermediate Size (28.5")	\$15.22 EA ★
<b>VXB20JNR</b>	Junior Size (27.5")	\$15.22 EA ★

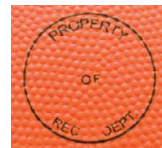

**Voit  
ENDURO CB2 Rec  
DEPT. BASKETBALL**

- Features "Property of Rec. Dept." logo
  - Durable rubber construction
  - Indoor/Outdoor use
- 2 Year Limited Warranty**



<b>VCB2HREC</b>	Official Size (29.5")	\$10.22 EA ★
-----------------	-----------------------	--------------



**COMPOSITE BASKETBALL WITH YMCA Logo**

- Composite leather ball printed with the YMCA logo
- Wide channel with a tacky grip
- Indoor/Outdoor use

<b>1384322</b>	Official Size (29.5")	\$24.22 EA ★
<b>1384323</b>	Intermediate Size (28.5")	\$24.22 EA ★
<b>1384324</b>	Junior Size (27.5")	\$24.22 EA ★



**RUBBER BASKETBALL WITH YMCA Logo**

- Printed with YMCA logo
- Durable rubber construction
- Indoor/Outdoor use

**2 Year Limited Warranty**

<b>1334098</b>	Official Size (29.5")	\$9.22 EA ★
<b>1334104</b>	Intermediate Size (28.5")	\$9.22 EA ★
<b>1334111</b>	Junior Size (27.5")	\$9.22 EA ★





**AUTOGRAPH BASKETBALL**

- Laminated synthetic leather (PVC) cover
- For display purposes only

**I072501** Official Size (29.5") \$24<sup>99</sup> EA ★



**SPALDING  
ROOKIE GEAR**

- High performance composite construction
- Specifically engineered for kids ages 8 and under
- 27.5" - weighs 25% less than a standard ball
- Indoor/Outdoor use

**I273281** Multi-Color \$26<sup>99</sup> EA  
**I273274** Brown \$26<sup>99</sup> EA



**MacGregor  
LIL' CHAMP**

- High pebble rubber construction
- 22" circumference for younger players
- Indoor/Outdoor use

**MCMINIBB** \$9<sup>99</sup> EA ★

**Voit  
LITE 80**

- Rubber construction
- 20% lighter than a standard ball
- Indoor/Outdoor use

**I291728** Intermediate Size (28.5") \$11<sup>99</sup> EA ★  
**I291735** Junior Size (27.5") \$11<sup>99</sup> EA ★



**MacGregor**

**MULTICOLOR BASKETBALLS**

- Durable rubber construction
- Deep channels and enhanced pebbling
- Indoor/Outdoor use

Color Options: **Blue, Green, Orange, Purple, Red, Yellow.**

**936021** Official Size (29.5") \$12<sup>99</sup> EA ★  
**935021** Intermediate Size (28.5") \$12<sup>99</sup> EA ★  
**934021** Junior Size (27.5") \$12<sup>99</sup> EA ★

**Voit  
LITE 80 PRISM PACK**

- Set includes 1 each: Blue, Green, Orange, Purple, Red and Yellow
- Rubber construction
- 20% lighter than a standard ball
- Indoor/Outdoor use

**I307030** Intermediate Size (28.5") \$64<sup>99</sup> SET OF 6 ★  
**I307047** Junior Size (27.5") \$64<sup>99</sup> SET OF 6 ★



**SPALDING  
TF-TRAINER 33" OVERSIZED**

- Exclusive composite construction
- Improves shooting accuracy
- Indoor use only

**I344110** \$54<sup>99</sup> EA



**SPALDING  
TF-TRAINER WEIGHTED**

- Weight: 3 lbs.
- Exclusive ZK composite construction
- Extends shooting range
- Improves arm, wrist and finger strength
- Indoor use only

**I344103** Official Size (29.5") \$49<sup>99</sup> EA  
**I366481** Intermediate Size (28.5") \$49<sup>99</sup> EA



**MacGregor  
HEAVY BALL**

- Heavy duty rubber construction
- Over 2 times heavier than a regulation ball
- Increase arm, wrist and finger strength
- Improves dribbling, passing and shooting
- Indoor/Outdoor use

**MCXHVMEN** Official Size (29.5"), 3.0 lbs. \$38<sup>99</sup> EA ★  
**MCXHVVWOM** Inter Size (28.5"), 2.5 lbs. \$38<sup>99</sup> EA ★

**OUTDOOR SYSTEMS**



**Backboard & pole pad included**

**BEST SELLER**

**GRIZZLY**

**GRIZZLY ADJUSTABLE BASKETBALL SYSTEM**

- Height adjusts from 7 1/2' to 10'
- 6" x 6" square powder coated, heavy-gauge steel post
- 42" x 72" x 3/8" thick clear acrylic regulation-size backboard welded to a heavy steel frame for extra support
- Height adjustment handle can be locked in place with a long shackle padlock (not included)
- Includes heavy-duty breakaway goal, nylon net, black post pad and backboard padding
- Uses J-bolt anchoring system

**1291247** 450 lbs. \$2,099<sup>22</sup> EA ★ **S&H**



**Pisen**

**ULTIMATE™ FIXED HEIGHT SYSTEM**

- 6" x 6" square powder coated, heavy-gauge steel post
- 42" x 60", 12 gauge steel, white powder coated backboard with graffiti-resistant finish and safety rolled edges to eliminate sharp contact points
- 60" safe play area
- Includes 5/8" double ring, ultimate playground goal with exclusive no-fail netlock system and nylon net (post pad not included)

**Lifetime Warranty**

**871444XX** 500 lbs. \$2,599<sup>22</sup> EA **S&H**

**Pisen**

**ULTIMATE™ ADJUSTABLE SYSTEM**

- Easy to use crank adjusts the backboard height from 7 1/2' - 10' with an easy-to-read goal height indicator
- 6" x 6" square, powder coated heavy-gauge steel post
- 42" x 72" x 1/2" thick polycarbonate backboard
- 50" safe play area at 10' height (60" at 9', 64" at 8')
- Includes double rim heavy duty flex goal and net with no-fail net lock system
- Uses J-bolt anchoring system
- Post pad and backboard padding not included

**Lifetime Warranty**

**984445XX** 610 lbs. \$3,899<sup>22</sup> EA **S&H**



**Pisen** **NEW!**

**ULTIMATE JR. SYSTEM**

- 5" x 5" square powdered coated steel pole
- 5" x 5" square extension arm places backboard 36" away from pole
- Aluminum fan backboard w/breakaway goal - 35 1/2"H x 54"W
- Steel rectangular backboard w/flex goal - 42"H x 60"W

<b>1388087</b>	Fan Aluminum	\$1,799 <sup>22</sup> EA	<b>S&amp;H</b>
<b>1388088</b>	Rectangular Steel	\$1,899 <sup>22</sup> EA	<b>S&amp;H</b>



**Pisen**

**ULTIMATE™ OUTDOOR GLASS SYSTEM**

- Same features as Ultimate system (871444XX) but with full size 42" x 72" competition glass backboard, heavy-duty flex goal, nylon net, post pad and backboard padding
- Lifetime guarantee on pole, five year limited guarantee on backboard, one year limited guarantee on goal and padding

**Lifetime Warranty**

**987344XX** 600 lbs. \$4,099<sup>22</sup> EA **S&H**



**Pisen**

**ULTIMATE™ ADJUSTABLE STEEL SYSTEM**

- Same features as above "Ultimate" system but with 42" x 60" lifetime guarantee, graffiti-resistant, powder coated steel backboard

**20020498** 575 lbs. \$3,199<sup>22</sup> EA **S&H**



**Pisen**

**ULTIMATE™ PERFORATED OUTDOOR SYSTEM**

- Same features as Ultimate system (871444XX) but with a larger 42" x 72" perforated steel backboard
- Post pad not included

**1187670** 525 lbs. \$3,499<sup>22</sup> EA **S&H**

**ULTIMATE™ POLE PADDING**

- Protect players from injury caused by contact with pole
- 1" thick and 74" high vinyl covered foam
- Velcro attachment straps

**870444XX** Black only \$599<sup>22</sup> EA



## OUTDOOR SYSTEMS



### 90° OFFSET ADJUSTABLE POST SYSTEM

- System includes post, backboard, diagonal backboard braces, goal and net
- 4.5" O.D. post with a 4' extension arm
- White backboard with shooter's square
- Height adjusts from 0' to 10'

#### Lifetime Warranty

<b>5047OVH4W</b>	4 1/2" Post - White Backboard with Shooter's Square	\$1,139 <sup>22</sup> EA	★
<b>5047OVH4</b>	4 1/2" Post - Silver Backboard W/O Shooter's Square	\$1,089 <sup>22</sup> EA	★
<b>5047XXXW</b>	3 1/2" Post - White Backboard with Shooter's Square	\$939 <sup>22</sup> EA	★
<b>5047XXX</b>	3 1/2" Post - Silver Backboard W/O Shooter's Square	\$889 <sup>22</sup> EA	★



### EXTRA-TOUGH PLAYGROUND SYSTEMS

These units are built to withstand the extra-heavy use of your playground. The goal, backboard and one-piece, 4 1/2" O.D. galvanized steel post bolt together, forming a single solid unit with either a 4' or 5' safety play area.

#### SYSTEM WITH LIFETIME RIM

System includes super goal double rim, nylon net and your choice of silver or white powder-coated aluminum backboard.

#### Lifetime Warranty

<b>5005NLNLR</b>	4' Ext - Silver Backboard W/O Shooter's Square	\$909 <sup>22</sup> EA	★
<b>5005NLWBRLR</b>	4' Ext - White Backboard with Shooter's Square	\$939 <sup>22</sup> EA	★
<b>5005NLN5LR</b>	5' Ext - Silver Backboard W/O Shooter's Square	\$929 <sup>22</sup> EA	★
<b>5005N5WBRLR</b>	5' Ext - White Backboard with Shooter's Square	\$959 <sup>22</sup> EA	★

#### SYSTEM WITH BREAKAWAY RIM

System includes breakaway rim, nylon net and your choice of silver or white powder-coated aluminum backboard.

#### Lifetime Warranty

<b>5005NLNBA</b>	4' Ext - Silver Backboard W/O Shooter's Square	\$919 <sup>22</sup> EA	★
<b>5005NLWBBA</b>	4' Ext - White Backboard with Shooter's Square	\$949 <sup>22</sup> EA	★
<b>5005NLN5BA</b>	5' Ext - Silver Backboard W/O Shooter's Square	\$939 <sup>22</sup> EA	★
<b>5005N5WBBA</b>	5' Ext - White Backboard with Shooter's Square	\$969 <sup>22</sup> EA	★

#### SYSTEM WITH DOUBLE RIM AND CHAIN NET

System includes double rim, steel chain net and your choice of silver or white powder-coated aluminum backboard.

#### Lifetime Warranty

<b>5005XXXX</b>	4' Ext - Silver Backboard W/O Shooter's Square	\$839 <sup>22</sup> EA	★
<b>5005WBXX</b>	4' Ext - White Backboard with Shooter's Square	\$879 <sup>22</sup> EA	★
<b>5005OVH5</b>	5' Ext - Silver Backboard W/O Shooter's Square	\$839 <sup>22</sup> EA	★
<b>5005H5WB</b>	5' Ext - White Backboard with Shooter's Square	\$889 <sup>22</sup> EA	★

#### PROTECTIVE POST PADS

- 6'H post pad constructed of 4" thick high-density urethane foam encased in 18 oz. vinyl
- Available in two sizes with zipper or hook-and-loop closure designs
- Please specify color. Red and Blue in stock.
- Allow 4 to 6 weeks for colors other than Red or Blue
- Optional one-color or two-color lettering available at additional cost

1362696	Hook & Loop up to 4 1/2" O.D. Post	\$289 <sup>22</sup> EA
1362697	Zipper Closure up to 4 1/2" O.D. Post	\$289 <sup>22</sup> EA ★
1366530	Hook & Loop 5" - 6 1/2" O.D. Post	\$319 <sup>22</sup> EA
1366529	Zipper Closure 5" - 6 1/2" O.D. Post	\$319 <sup>22</sup> EA ★

#### OPTIONAL LETTERING FOR POST PADS

- Add up to (8) 8" letters to your post pads
- Letters will be one-color or two-color block style
- Please allow 4 - 6 weeks production time

1362695	One-Color	\$129 <sup>22</sup> EA
1376909	Two-Color	\$219 <sup>22</sup> EA

#### PAD AND INK COLOR OPTIONS

BLACK	LIGHT BLUE	DARK GREEN	GRAY	VEGAS GOLD	MAROON	NAVY
ORANGE	PURPLE	SCARLET	ROYAL	METALLIC SILVER	WHITE	METALLIC GOLD

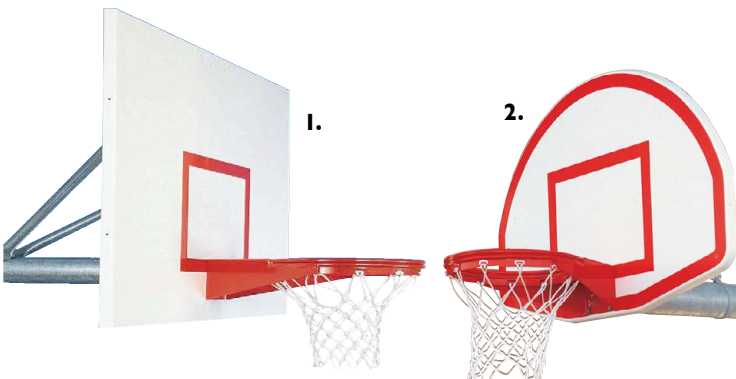

### MEGA DUTY BASKETBALL UNITS

- 5 9/16" O.D. galvanized steel pole
- 72" safe play area
- Goal mounts directly through backboard to pole to virtually eliminate stress on backboard when hanging occurs
- Heavy 1 5/8" backboard braces
- 48" in-ground bury
- System includes ultimate double rim, nylon net, backboard, backboard brace and post

#### Lifetime Warranty

1. 20020077	Steel Rectangular Backboard - 42" x 60"	\$2,499 <sup>22</sup> EA	★
2. 20020075	Aluminum Fan Backboard - 35" x 54"	\$2,199 <sup>22</sup> EA	★
3. 20020078	Polycarbonate Backboard - 42" x 54"	\$2,999 <sup>22</sup> EA	★

## PORTABLE SYSTEMS

**porter****735 SERIES PORTABLE STANDARD**

- Effortless height adjustments at 8', 9' or 10' goal heights.
- When in the playing position, the base is locked into position by four, foot-operated retractable floor pads.
- Porter's exclusive Center-Strut® provides a direct goal-mount system which withstands slam dunking and prevents glass backboards from shattering.
- Each unit includes: official size, 72" x 42" glass backboard, Torq-Flex® adjustable goal with anti-whip net included, ballast concealed in base and fully padded with 2" thick shock-absorbing material. Padding available in 14 colors.

**10 Year Limited Warranty**

Color Options: **Black, Dark Green, Grey, Kelly Green, Light Blue, Maroon, Navy, Orange, Purple, Red, Royal, Tan, White, Yellow Gold.**

1383928

Specify Color \$8,599<sup>22</sup> EA **SPALDING****FASTBREAK 960 PORTABLE BASKETBALL STANDARD**

- Features goal height adjustment from 7' to 10'
- Extension arm provides 6' safe play area at 10' goal height
- Multi-piece base padding included (black)
- Folds easily by two people in minutes
- Includes 60" x 36", 3/8" thick high performance, aluminum framed acrylic backboard, Pro Image™ breakaway goal and nylon net
- Requires 300 lbs. of ballast (not included)

**2 Year Limited Warranty**

1048216

\$3,399<sup>22</sup> EA**FASTBREAK 940 PORTABLE BASKETBALL STANDARD**

- Same features as 960 model but with a smaller 54" x 32" aluminum framed acrylic backboard

**2 Year Limited Warranty**

1048223

\$2,899<sup>22</sup> EA**CLUB COURT PORTABLE BASKETBALL SYSTEMS**

- 36" x 54" tempered glass backboard with break-a-way goal
- Spring assisted goal height adjustment from 6 1/2' to 10' with goal height indicator labels
- 1 1/2" thick, black padded front base and riser
- Oversized ballast box holds either 425 lbs. or 850 lbs. of ballast (not included)
- Goal mounts directly to extension arm, eliminating stress on backboard during play
- Folds without tools for transport on non-marking casters (fits through 78" high double doors)

**2 Year Limited Warranty**

1299373

Super Club Court \$3,499<sup>22</sup> EA **ACRYLIC CLUB COURT**

- 32" x 48" acrylic backboard
- Flex goal
- 36" safe play area when goal is at 10'
- Requires 425 lbs. of ballast (not included)

833444XX

\$2,399<sup>22</sup> EA **MICRO-Z PORTABLE BASKETBALL SYSTEM**

- Spring assisted height adjustment from 7' to 10'
- Black padded front base and riser
- Folds easily for transport on four large casters
- Includes a 48" x 32" acrylic backboard and an official size stationary rim with nylon net
- Requires 250 lbs. of ballast (not included)
- Backboard padding not included
- Not for main court use or dunking activities

**2 Year Limited Warranty**

1237481

Complete Unit

\$2,299<sup>22</sup> EA 

1237498

Replacement Rim

\$99<sup>22</sup> EA

1237504

Replacement Backboard

\$549<sup>22</sup> EA



### **Piscataway** **GYMNASIUM™ HEIGHT ADJUSTMENT SYSTEMS**

- Adjusts rim height from 10' to 8' and anywhere between using hand crank operated from the floor
- Easy-to-read height indicator labels
- Heavy duty 2" square silver powder coated steel structure moves backboard 4 1/4" closer to the free throw line
- Most fan boards have 20" x 35" mounting
- Most 42" x 72" boards have 36" x 62" mounting
- Most 48" x 72" boards have 42" x 62" mounting

5043XXXX	20" x 35" Fan Mounting	\$1,299 <sup>22</sup> EA	
5042XXXX	36" x 62" Mounting	\$1,499 <sup>22</sup> EA	
5044XXXX	42" x 62" Mounting	\$1,399 <sup>22</sup> EA	



### **Piscataway** **QWIKCHANGE™ SHOOTING STATION**

- Entire system mounts easily to the wall with two load spreading struts
- No ladders or tools
- 7 1/2' to 10' goal height adjusts from the playing surface in 6" increments
- Mounts indoors/outdoors
- 22" safe play area at 10'
- **Wall mounting hardware not included**

20020250	1) Fan Shaped Graphite 36" x 48"	\$799 <sup>22</sup> EA	
1187687	2) Rectangular Acrylic 32" x 48"	\$1,099 <sup>22</sup> EA	

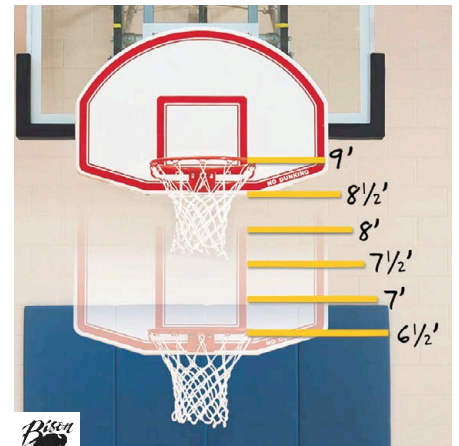

### **Piscataway** **6-IN-1 EASY-UP™ YOUTH MINI GOAL**

- Can be adjusted to 6 different heights (6 1/2' to 9')
- Lowers rim and moves rim 24" closer to free throw line; full sized rim
- Total system weight is less than 40 lbs.
- 32" x 48" backboard is molded of high impact ABS plastic
- Ships assembled and fits any style goal
- Not suitable for dunking or hanging from goal

1295825	\$799 <sup>22</sup> EA
---------	------------------------



### **Piscataway** **ZIP CRANK™ ADJUSTABLE SHOOTING STATION**

- 36" x 54" x 1/2" thick acrylic backboard looks and plays much like higher priced glass systems
- Easy to operate, removable hand crank adjusts goal height from 7 1/2' to 10'
- Competition design breakaway goal and direct goal mount design makes backboard virtually unbreakable during normal play
- Steel structure mounts to wall by means of three load spreading struts
- Mounts indoors/outdoors and has 30" safe play area at 10'
- **Wall mounting hardware not included**

20020300	\$1,899 <sup>22</sup> EA	
----------	--------------------------	--



### **Piscataway** **PLAYTIME™ BASKETBALL STANDARD**

- Telescoping adjustment from 6'6" to 8' (6" increments)
- 34" white powder coated formed steel base
- Rubber rim protects the floor
- Goal, net, blue protective pad and hardware included
- Built-in 100 lb. ballast
- Indoor or outdoor use

20020803	\$1,099 <sup>22</sup> EA	
1271676	Replacement Backboard \$229 <sup>22</sup> EA	



### **Piscataway** **QWIKCHANGE™ PLAYGROUND SYSTEM**

- Height adjusts from 7 1/2' to 10' (6" increments) without unbolting the backboard
- Includes 72" high black pole safety padding, reflex rim and net
- 34" base weighs 340 lbs. for stability
- Heavy duty 3 1/2" galvanized steel pole
- Base has (2) 3" heavy-duty wheels for easy transport
- **Outdoor use only**

20020801	Fan Shaped Graphite 36" x 48"	\$1,699 <sup>22</sup> EA	
20028011	Rectangular Acrylic 32" x 48"	\$1,799 <sup>22</sup> EA	

**Base is large and heavy for increased stability!**



### **Piscataway** **QWIKCHANGE™ 34" BASE COVER**

- 1" thick foam with black vinyl cover
- Hook and loop attachment

20020892	\$239 <sup>22</sup> EA
----------	------------------------



**1.**

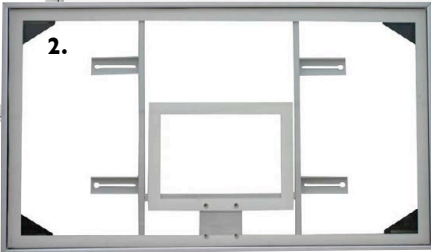

**2.**



**1. REGULATION SIZE ACRYLIC BACKBOARD**

- Heavy duty 3/8" thick acrylic backboard in a heavy duty 1 1/2" wide steel frame
- Regulation size 42" x 72" with standard 36" x 62" backboard mounting pattern
- Standard 5" x 5" goal mounting pattern

**2 Year Limited Warranty**

1245943 \$999<sup>22</sup> EA 

**2. CONVERSION ACRYLIC BACKBOARD**

- Regulation size 42" x 72", includes bolt-on conversion frame for use when replacing a fan shaped backboard

1245936 \$1,099<sup>22</sup> EA 



**Piscataway**

**UNBREAKABLE™ SHORT GLASS BACKBOARD**

- 42" x 72" with 1/2" thick tempered glass
- Built-in goal leveling device
- 35 1/2" x 62" mounting bracket spacing and 5" x 4" goal mounting pattern
- Pre-drilled for Duraskin™ padding
- Note: The glass itself is not unbreakable. Breakage in transit, during mounting, malicious acts, or deliberate attempts to damage are not covered under this guarantee.
- Color options: Black, Brown, Burnt Orange, Cardinal, Columbia Blue, Forest Green, Gold, Grey, Kelly Green, Maroon, Navy, Orange, Purple, Royal, Scarlet, Vegas Gold

**Lifetime Warranty**

5150XXXX	Backboard with Padding	\$1,299 <sup>22</sup> EA	
5151XXXX	Backboard Only	\$1,099 <sup>22</sup> EA	



**SPALDING**

**SUPERGLASS™ COLLEGIATE PACKAGE**

- Includes 1/2" tempered glass backboard, Slam Dunk goal with net and bolt-on backboard padding
- 36" x 63" mounting bracket spacing
- Meets all NCAA, NFHS and FIBA specifications

**7 Year Limited Warranty**



Color Options: **Black, Forest Green, Gold, Grey, Kelly, Maroon, Navy, Orange, Purple, Royal, Scarlet.**

1048292	42" x 72"	\$1,899 <sup>22</sup> PACK	
---------	-----------	----------------------------	---

**SUPERGLASS™ COLLEGIATE BACKBOARD ONLY**

- 42" x 72" board has 5" x 4" goal mounting pattern
- 48" x 72" board has 5" x 5" goal mounting pattern

**7 Year Limited Warranty**

1048247	42" x 72"	\$1,299 <sup>22</sup> EA	
1048261	48" x 72"	\$1,399 <sup>22</sup> EA	





**Piscataway**

**HIGH SCHOOL BACKBOARD PACKAGE**

- 42" x 72" glass backboard
- TruFlex Breakaway rim
- DuraSkin padding

**Lifetime Warranty**

Color Options: **Black, Brown, Burnt Orange, Cardinal, Columbia Blue, Forest, Gold, Grey, Kelly, Maroon, Navy, Orange, Purple, Royal, Scarlet, Vegas Gold.**

1376347	Backboard, Goal and Padding	\$1,599 <sup>22</sup> EA	
5028XXXX	42" x 72" Backboard Only	\$999 <sup>22</sup> EA	
5027XXXX	48" x 72" Backboard Only	\$1,049 <sup>22</sup> EA	



**Piscataway**

**UNBREAKABLE™ TALL GLASS BACKBOARD**

- 48" x 72" with 1/2" thick tempered glass
- Built-in goal leveling device
- 42" x 62" mounting bracket spacing and 5" x 5" goal mounting pattern
- Pre-drilled for Duraskin™ padding (not included)
- Note: The glass itself is not unbreakable. Breakage in transit during mounting, malicious acts, or deliberate attempts to damage are not covered under this guarantee.

**Lifetime Warranty**

1302776	240 lbs.	\$1,199 <sup>22</sup> EA	
---------	----------	--------------------------	---







**AlFRG - ALUMINUM FRAME GLASS BOARD**

- Heavy duty corner brackets and direct to goal mounting allows for disbursement of stress along the extruded frame
- 1/2" tempered glass with fired-in target and border
- 5" x 4" goal mounting pattern
- Meets NCAA, NAIA & NFHS specifications

**Lifetime Warranty**

1091974	42" x 72" Backboard Only	\$1,099 <sup>22</sup> EA	
1237429	48" x 72" Backboard Only	\$1,149 <sup>22</sup> EA	



**Piscataway**

**UNBREAKABLE POLYCARBONATE BACKBOARD**

- 42" x 54" with white shooter's square
- 1/2" thick polycarbonate material is virtually bullet-proof
- 27" x 34 3/4" mounting bracket spacing and 5" x 4" goal mounting pattern

**Lifetime Warranty**

5407XXXX	130 lbs.	\$1,599 <sup>22</sup> EA	
----------	----------	--------------------------	---

**porter**

### PRO-STRUT CONVERSION BACKBOARD

- Official size 42" x 72" glass backboard is designed to mount at the same attachment points as a fan shaped backboard.
- Brushed aluminum extrusions secure 1/2" thick fully tempered glass to the unitized steel frame.
- Goal mount pattern is 5" x 4 1/2"
- Padding sold separately - see page 111

#### Lifetime Warranty

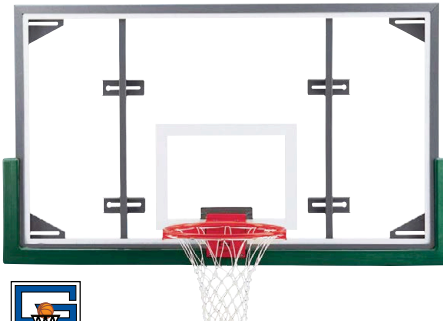
 1383914      210 lbs.      \$899<sup>22</sup> EA 

### ARG CONVERSION GLASS BACKBOARD

- 42" x 72" steel framed backboard
- Replaces fan shaped or small glass backboards
- Designed for direct, three or four point mounting with steel mounting plates which strengthen backboard and prevent glass damage
- Frame pre-drilled for padding (not included)
- 5" x 4" goal mounting
- Meets NCAA and NFHS specifications

#### Lifetime Warranty

 1237436      \$1,099<sup>22</sup> EA 

### CONVERSION GLASS BACKBOARDS

- Convert courts from fan-shaped to rectangular glass backboards
- Converts without a new mounting structure
- Ready to install with no drilling or relining of court
- Pre-drilled for DuraSkin® padding (not included)
- Mounting hardware included

#### Lifetime Warranty

 5155XXXX      42" x 72" - 223 lbs.      \$1,099<sup>22</sup> EA   
 5154XXXX      48" x 72" - 246 lbs.      \$1,499<sup>22</sup> EA 

### SIDE COURT CONVERSION GLASS BACKBOARD

- Same construction as the Bison full-size conversion board but 42" x 54" size makes it the most affordable glass option available

#### Lifetime Warranty

 407444XXX      175 lbs.      \$1,299<sup>22</sup> EA 

### FAN-SHAPED BACKBOARD

- 39" x 54" cushioned 1/2" tempered glass
- Heavy duty aluminum framework
- Shooter's square and border are fired into glass
- Standard 20" x 35" mounting brackets
- Color options: Black, Grey, Royal Blue, Scarlet

#### Lifetime Warranty

 5152XXXX      Board and Padding      \$1,599<sup>22</sup> EA   
 5153XXXX      Board Only      \$1,499<sup>22</sup> EA 



### STEEL REAR MOUNT BACKBOARD

- 35" x 54" backboard with 4" x 3 5/8" goal mounting pattern
- Standard 20" x 35" mounting
- Vibration-free unit stabilized by 12 gauge horizontal and 10 gauge vertical channels
- Phosphate treated and powder coated for maximum protection against weathering

 1140118      Backboard with Goal and Net      \$599<sup>22</sup> EA   
 1140125      Backboard Only w/Target and Border      \$559<sup>22</sup> EA   
 1140132      Backboard Only - Solid White      \$499<sup>22</sup> EA 

### STEEL FRONT MOUNT BACKBOARD

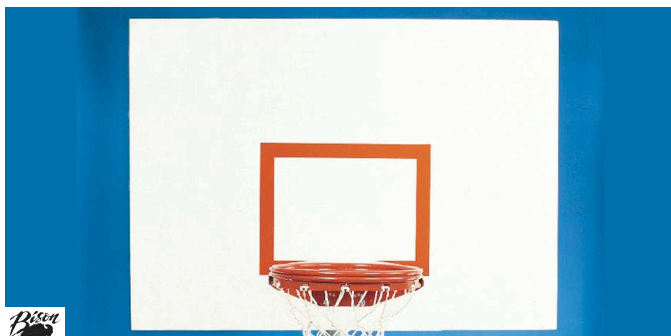
- 35" x 54" steel backboard with 5" x 4 1/2" goal mounting pattern
- Standard 20" x 35" mounting
- Phosphate treated and powder coated for maximum protection against weathering

 1140149      Includes Shooter's Square      \$499<sup>22</sup> EA   
 1140156      Solid White Backboard      \$469<sup>22</sup> EA 

### ULTIMATE™ STEEL BACKBOARD

- 42" x 60" backboard
- Graffiti resistant finish
- 5" X 5" goal mounting pattern
- 20" X 35" mounting brackets
- Attaches to any current fan-shaped ceiling or wall mounted structure

#### 10 Year Limited Warranty

 5156XXXX      Backboard Only      \$949<sup>22</sup> EA 

### ALUMINUM BACKBOARD

- 35" x 54" one-piece cast aluminum alloy; twice as thick but half the weight of steel
- Universal goal mounting pattern
- Shooter's square included on white backboard only
- Hardware included when purchasing board AND goal

#### Lifetime Warranty

 1343045      White Powder Coated Backboard with Goal and Net      \$529<sup>22</sup> EA ★   
 5035XXXX      Silver Backboard with Goal and Net      \$499<sup>22</sup> EA ★   
 1171518      White Powder Coated Backboard Only      \$449<sup>22</sup> EA ★

## GOALS



**BEST SELLER**

**MacGregor**  
**GAME SERIES BREAKAWAY GOAL**

- Front mount, 5/8" solid steel, powder coated rim
- Traditional ball-and-socket breakaway design
- Continuous no-tie net attachment
- Universal goal mounting pattern
- Includes net and mounting hardware
- Indoor/Outdoor use

5555XXXX \$149<sup>99</sup> EA ★



**1000 SCHOLASTIC BREAKAWAY GOAL**

- Front mount, 5/8" solid steel, powder coated single rim
- Unique stack spring construction for true rebound
- Continuous no-tie net attachment
- 4" x 5" goal mounting pattern
- Includes net and mounting hardware
- Meets NCAA, NFHS and NAIA specifications
- Indoor use only

**2 Year Limited Warranty**

1237443 \$219<sup>99</sup> EA



**NEW!**  
**porter**  
**ULTRA-FLEX II BREAKAWAY GOAL**

- Front mount, 5/8" solid steel, powder coated single rim
- Designed to release with 180 lb. static load
- Tube-tie net attachment system
- 5" x 4-1/2" goal mounting pattern
- Includes anti-whip net and mounting hardware
- Meets NCAA Div 2 & 3 and NFHS specifications

**3 Year Limited Warranty**

1388578 \$219<sup>99</sup> EA



**Piscataway**  
**ProTECH™ BREAKAWAY GOAL**

- Front mount, 5/8" solid steel, powder coated single rim
- Traditional ball and socket positive lock mechanism
- Continuous no-tie net attachment
- 4" x 5" and 5" x 5" goal mounting patterns
- Includes net and mounting hardware
- Meets NCAA and NFHS specifications
- Indoor use only

**3 Year Limited Warranty**

354444XX \$289<sup>99</sup> EA



**Piscataway**  
**REACTION ADJUSTABLE TENSION BREAKAWAY GOAL**

- Front mount, 5/8" solid steel, powder coated single rim
- AcuFlex adjustable positive lock mechanism allows fine tuning of tension for ideal playing conditions
- Hideaway net attachment system
- 4" x 5" and 5" x 5" goal mounting patterns
- Includes net and mounting hardware
- Meets NCAA and NFHS specifications
- Indoor use only

**4 Year Limited Warranty**

354445XX \$379<sup>99</sup> EA



**Piscataway**  
**ELITE™ BREAKAWAY GOAL**

- Front mount, 5/8" solid steel, powder coated single rim
- Low maintenance breakaway mechanism with padded cover-plate
- Six point lubrication system for smooth action (lubrication gun incl.)
- Continuous no-tie net attachment
- 4" x 5" and 5" x 5" goal mounting patterns
- Includes net and mounting hardware
- Meets NCAA and NFHS specifications
- Indoor use only

**5 Year Limited Warranty**

5111XXXX Breakaway Goal \$369<sup>99</sup> EA



**COLLEGIATE 2000 BREAKAWAY GOAL**

- Front mount, 5/8" solid steel, powder coated single rim
- Adjustable positive lock mechanism allows precise fly-back action
- Continuous no-tie net attachment
- 4" x 5" goal mounting pattern
- Includes net and mounting hardware
- Meets NCAA, NFHS and NAIA specifications
- Indoor use only

**4 Year Limited Warranty**

5038XXXX \$259<sup>99</sup> EA



**6600 REAR MOUNT BREAKAWAY GOAL**

- Rear mount, 5/8" solid steel, powder coated single rim
- Continuous no-tie net attachment
- 4" x 3 7/8" goal mounting pattern
- Includes net and mounting hardware
- Indoor/Outdoor use

5545XXXX \$239<sup>99</sup> EA



**SPALDING**  
**SLAM DUNK PRO GOAL**

- Front mount, 5/8" solid steel, powder coated single rim
- Top adjust positive lock release mechanism
- Easy glide #2 net attachment system
- Universal goal mounting pattern
- Includes net and mounting hardware
- Meets NBA, NCAA and NFHS specifications
- Indoor use only

**7 Year Limited Warranty**

1007923 \$319<sup>99</sup> EA  
1388019 #2 Net Cable \$29<sup>99</sup> EA



## GOALS



**MacGregor**

### DOUBLE RIM FRONT MOUNT GOAL

- Double 5/8" solid steel, powder coated rim
- Flex design with 15 degree deflection auto return
- Universal goal mounting pattern
- Includes net and mounting hardware
- Indoor/Outdoor use

1046045

\$199<sup>99</sup> EA ★



### 7550 - TITAN FRONT MOUNT PLAYGROUND GOAL

- Double rings (1/2" top ring & 3/4" bottom ring)
- Continuous no-tie net attachment
- 5" x 5" mounting pattern
- Includes net and mounting hardware
- Outdoor use

**Lifetime Warranty**

1237467

\$189<sup>99</sup> EA



### 240 - DOUBLE RIM FRONT MOUNT SUPER GOAL

- Double rings (5/8" top ring, 1/2" bottom ring)
- Continuous no-tie net attachment
- 4" x 5" and 5" x 5" mounting patterns
- Includes net and mounting hardware
- Outdoor use

**2 Year Limited Warranty**

1237474

\$129<sup>99</sup> EA



**MacGregor**

### FRONT MOUNT ECONOMY GOAL

- Front mount, 5/8" solid steel, powder coated single rim
- 1/2" reinforcing bars
- Continuous no-tie net attachment
- Universal goal mounting pattern
- Includes net and mounting hardware
- Indoor/Outdoor use

1061086

\$56<sup>99</sup> EA ★



**SPALDING**

### SLAMMER COMPETITION 180° GOAL

- Front mount, 5/8" solid steel, powder coated single rim
- Adjustable tension 180° side and front flex action
- Easy-glide net attachment system
- Universal mounting pattern
- Includes net and mounting hardware
- Meets NFHS specifications
- Indoor use only

**5 Year Limited Warranty**

1008210

\$389<sup>99</sup> EA

1388019

#2 Net Cable \$29<sup>99</sup> EA



### 5500 - DOUBLE RIM FRONT MOUNT BREAKAWAY GOAL

- Double 5/8" solid steel, powder coated rim
- Double spring flex breakaway mechanism
- No-tie net attachment
- 4 1/2" x 5" goal mounting pattern
- Includes net and mounting hardware
- Outdoor use

**3 Year Limited Warranty**

1237450

\$249<sup>99</sup> EA



### REAR MOUNT DOUBLE RIM GOAL

- Double 5/8" rings, solid steel, powder coated rim
- Continuous no-tie net attachment
- Universal goal mounting pattern
- Includes net and mounting hardware
- Outdoor use

20020031

\$199<sup>99</sup> EA



**MacGregor**

### ENDURO FRONT MOUNT PLAYGROUND GOAL

- Double 5/8" solid steel, powder coated rim
- Reinforced design for superior support
- Exclusive 'no-fail' net-lock system
- Universal goal mounting pattern
- Includes net and mounting hardware
- Outdoor use

**Lifetime Warranty**

1038859

\$149<sup>99</sup> EA ★



**Pisen**

### FRONT MOUNT FLEX GOAL

- Front mount, 5/8" solid steel, powder coated single rim
- Flex design with 15 deflection-auto return
- Continuous no-tie net attachment
- Universal goal mounting pattern
- Includes net and mounting hardware
- Indoor use

5132XXXX

\$249<sup>99</sup> EA



### 66T - REAR MOUNT INSTITUTIONAL GOAL

- Rear mount, 5/8" solid steel, powder coated single rim
- No-tie net attachment
- 4" x 3 7/8" mounting pattern
- Includes net and mounting hardware
- Outdoor use

20015034

\$109<sup>99</sup> EA



**SPALDING**

### ROUGHNECK GORILLA GOAL

- Front mount, 5/8" solid steel, powder coated single rim
- 5/8" reinforcing bars
- Continuous no-tie net attachment
- Universal mounting pattern
- Includes net and mounting hardware
- Indoor/Outdoor use

3213XXXX

\$159<sup>99</sup> EA



**MacGregor**

### FRONT MOUNT SUPER GOAL

- 5/8" top ring, 1/2" bottom ring, powder coated solid steel
- Two rim support braces for strength
- Universal goal mounting pattern
- Includes net and mounting hardware
- Indoor/Outdoor use

**Lifetime Warranty**

1187786

Nylon Net \$89<sup>99</sup> EA ★

5001XXXX

Chain Net \$99<sup>99</sup> EA ★

## INDOOR NETS

**BRUTE**

- 288 gram, 12 loop, braided nylon

SNBBN288Y \$6<sup>99</sup> EA ★

**HEAVY DUTY ANTI-WHIP**

- 145 gram, 12 loop, braided nylon

SNBBNWIPY \$5<sup>99</sup> EA ★

**STANDARD DUTY**

- 144 gram, 12 loop, braided nylon

SNBBN144Y \$3<sup>99</sup> EA ★

**TRADITIONAL**

- 90 gram, 12 loop, braided nylon

SNBBN90XY \$2<sup>99</sup> EA ★

**PERMANET HIGH ENDURANCE BASKETBALL NET**

- 2000 lb. high-strength, flexible steel cable construction lasts up to 18 times longer than a standard basketball net
- Large loop design and protective vinyl coating help minimize hand injuries
- Rimlock theft-deterrent system permanently attaches net to rim
- Unique design resists sticking, tangling, fraying, shrinkage and rotting
- **Rim not included**

1079715

\$29<sup>99</sup> EA ★

## OUTDOOR NETS

**BRAIDED POLY NET**

- 3mm, 12 loop, braided polyethylene
- 400% more durable than nylon
- Designed for outdoor use

SNBBNPBRY \$3<sup>99</sup> EA ★

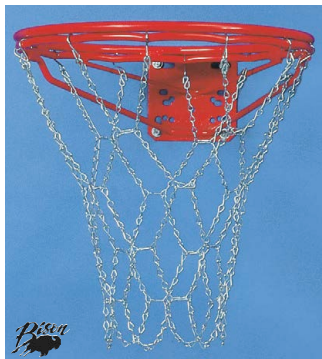
**STEEL CHAIN NO-TIE SUPER NET**

- 12 loop, zinc plated galvanized steel provides protection from weather
- Includes heavy-duty "S" hooks for attachment to any style rim

SNBBSTLN \$24<sup>99</sup> EA

**PREMIUM STEEL PLAYGROUND NET**

- Zinc plated chain is three-times heavier than typical chain nets
- All links are welded into closed loops to prevent separation when chains are stretched during play
- Includes heavy-duty S-hooks for attachment to any style rim

**2 Year Limited Warranty**

504444XX \$64<sup>99</sup> EA

**WEB OUTDOOR NET**

- Flat strap design improves outdoor durability while maintaining the feel of traditional nylon nets
- Triple-stitched with non-rotting nylon thread
- Includes heavy-duty S-hooks for attachment to any style rim

SNBBN505 \$39<sup>99</sup> EA ★

**ADJUSTO-BRACKET GOAL MOUNT**

- Simply attach the Adjusto-Bracket to any flat surface and slide your goal into place to create a basketball play area
- For use on brick, wood, block or tile
- Goal not included
- 8 1/2"H x 7"W - 2 lbs.

4998XXXX \$89<sup>99</sup> EA

**GOAL FOR ADJUSTO BRACKETS**

- For use with single or double Adjusto-Bracket goal mounts

5004XXXX \$69<sup>99</sup> EA

**DOUBLE ADJUSTO-BRACKET GOAL MOUNT**

- Allows 12" height adjustment on one bracket to accommodate different age/height requirements
- 17"H x 8 1/2"W - 4 lbs.

4997XXXX \$129<sup>99</sup> EA

## BACKBOARD PADDING



### SAF-GUARD CUSHION EDGE BACKBOARD PADDING

- Soft, durable backboard padding made from high density polyurethane foam with tough outer skin
  - Fits most standard 72" wide glass or acrylic backboards
  - Reinforced, pre-drilled bolt holes for easy installation (mounting hardware included)
  - Meets NCAA and NFHS specifications
  - Indoor use only
- Color Options: **Black, Grey, Navy, Red, Royal Blue.**

**BB72** Specify Color \$179<sup>22</sup> EA ★



### DURASKIN BACKBOARD SAFETY PADDING

- Fits every manufacturers' official 72" backboard but might require frame drilling on non-Bison backboards (will not work with Zip Crank)
  - Reinforced, pre-drilled bolt holes for easy installation (mounting hardware included)
  - Meets NCAA, FIBA and NFHS specifications
  - Indoor use only
  - Rectangular color options: **Black, Brown, Burnt Orange, Cardinal, Columbia Blue, Forest Green, Gold, Grey, Kelly Green, Maroon, Navy, Orange, Purple, Royal, Scarlet, Vegas Gold**
  - Fan-shaped color options: **Black, Grey, Royal, Scarlet**
- 10 Year Limited Warranty**

5054XXXX For Rectangular Backboards \$239<sup>22</sup> EA  
 5468XXXX For Fan-Shaped Backboards \$239<sup>22</sup> EA



### PRO-MOLD BACKBOARD PADDING

- Soft, durable backboard padding made from high density polyurethane
  - Fits most standard 72" wide glass or acrylic backboards
  - Reinforced, pre-drilled holes for installation
  - Mounting hardware included
  - Meets NCAA, NBA & NFHS specifications
  - Indoor use only
- Color Options: **Black, Dark Green, Gold, Grey, Kelly, Maroon, Navy, Purple, Royal, Scarlet.**

1092000 Specify Color \$219<sup>22</sup> EA



### PRO BOLT-ON BACKBOARD PADDING

- Extremely durable molded padding which meets all NBA, NCAA, NFHS and FIBA requirements.
  - Choose from 12 colors
- 3 Year Limited Warranty**
- Color Options: **Black, Dark Green, Grey, Kelly Green, Light Blue, Maroon, Navy, Orange, Purple, Red, Royal, Yellow Gold.**

1383915 Specify Color \$229<sup>22</sup> EA



**NEW!**



### ADHESIVE BACKBOARD PADDING

- Fits 2" Thick Backboards
- Molded from self-skinning polyurethane foam
- Fast-setting adhesive installation
- Pads two backboards

1383987 Grey Only - Pair \$269<sup>22</sup> PR



**THE STADIUMCHAIR COMPANY**



Deluxe



Tall Deluxe

**DELUXE SIDELINECHAIR**

- Available with 3" or 2" cushions for same cost
- Dimensions: 40 1/2"H x 17 3/4"W; Seat Dimension: 15 1/4"W x 16"D
- Includes 2-color printing in 2 locations, 1-color printing in 1 location
- Tall version is 3" taller for more legroom
- Weight capacity: 450 lbs.
- Specify color for frame, cushion and printing
- Minimum order of 24 chairs
- Delivery 6-8 weeks after artwork approval for Deluxe
- Delivery 10-12 weeks after artwork approval for Tall Deluxe

**15 Year Limited Warranty**

1307252	Deluxe SidelineChair	\$129 <sup>92</sup> EA	
1307245	Tall Deluxe SidelineChair	\$139 <sup>92</sup> EA	
1325928	Optional Ganging Device	\$9 <sup>92</sup> EA	

Frame colors: **Black, Red, Navy, Royal Blue**

Vinyl colors: **Black, Red, Navy, Royal Blue, Purple, White, Maroon, Forest Green**



Slip cover



**UNIVERSAL FOLDING CHAIR**

- Features curved backrest for lumbar support, with thick, comfortable seat cushion
- No-Slide grippers help keep chair in place
- Dimensions: 32"H x 17 1/2"W x 20"D
- Includes 2-color printing in 2 locations
- Weight capacity: 300 lbs.
- Specify frame, cushion and printing colors
- Minimum order of 24 chairs
- Delivery 6-8 weeks after artwork approval

1307276	Universal Folding Chair	\$89 <sup>92</sup> EA	
1325928	Optional Ganging Device	\$9 <sup>92</sup> EA	



Tall Lockerstool

Lockerstool

**LOCKERSTOOL**

- Padded vinyl seat on strong steel frame
- Folds for easy storage
- Dimensions: 25"H x 14 3/4"W; Seat: 12 1/2" diameter
- Tall LockerStool is 3" taller for more legroom
- Weight capacity: 300 lbs.
- Specify frame color, cushion color and printing colors
- Minimum order quantity 24 stools
- Delivery 6-12 weeks after artwork approval

1307313	LockerStool	\$64 <sup>92</sup> EA	
1325911	Tall LockerStool	\$74 <sup>92</sup> EA	

**Tall locker stools**

Frame colors: **Black, Navy, Red, Royal Blue, White**  
 Vinyl colors: **Black, Forest Green, Maroon, Navy, Orange, Red, Royal Blue, Purple, White**

**Locker Stools**

Frame colors: **Black, Bright Gold, Forest Green, Kelly Green, Maroon, Navy, Orange, Red, Royal Blue, Purple, White**



**FISHER**

**"THE EDGE" DIGITALLY PRINTED CHAIR**

- Enhanced printing in as many colors and locations as you want for one low price!
- 2 1/2" thick seat padding, 1" padded seat back, 16 gauge steel frame
- Rubber cap ends help protect gym floors.
- Frame: Red, Royal, Black, Purple, Forest Green, Maroon, Navy, White and Silver
- Minimum order 6
- Please allow 4-6 weeks for delivery

1383871		\$139 <sup>92</sup> EA	
1383872	Chair Cart (Holds 36)	\$749 <sup>92</sup> EA	



**STADIUM BLEACHER SEATS**

- Durable steel-frame construction and cordura canvas
  - Bottom hook secures to bleacher; rubber non-slip skids
  - Folds neatly, attached tote handle
  - Measurements: Standard - 14 1/2"H x 17"W x 15 1/2"D; Deluxe - 14 1/2"H x 20"W x 15 1/2"D
  - Minimum order: 6
- Color Options: **Black, Brown, Burnt Orange, Columbia Blue, Forest, Gold, Kelly, Maroon, Navy, Orange, Pink, Purple, Red, Royal.**

1369554	Standard - Blank Canvas	\$49 <sup>92</sup> EA	
1369555	Deluxe - Blank Canvas	\$59 <sup>92</sup> EA	



**CHAIRCADDIE**

- Holds 36 SidelineChairs
- Dimensions: 68 1/4"H x 31 1/2"W x 60"L
- Frame and optional cover - Black only
- Only compatible with StadiumChair products

1307290		\$749 <sup>92</sup> EA	
1307306	Canvas Caddie Cover	\$99 <sup>92</sup> EA	

### EVERBRITE SCORERS TABLE

- 30 3/4" H x 29" W x 8' L table
- Will accommodate 3 people
- Shatter resistant polycarbonate illuminated panel slides in and out, making it possible to use different sponsors at different events (27 1/2" x 90 1/4" display area)
- Wood grain laminate counter with access holes for cables and 3 cup holders
- 3" locking casters to prevent movement
- Vinyl padding included
- Available in 8 colors (Black, Blue, Dark Green, Kelly Green, Maroon, Purple and Red)
- Ships fully assembled

1237283	Free Standing	\$3,699 <sup>22</sup> EA	
1237290	Bleacher Mount - 8'	\$4,099 <sup>22</sup> EA	
1237306	Optional Padded Possession Indicator 4" X 16"	\$389 <sup>22</sup> EA	



Free Standing

Bleacher Mount



### SPORT PRIDE SCORERS TABLES

- 8' L x 16" D table will accommodate 4 people
- Folds easily for storage and transports on built-in, floor friendly casters
- Padding is vinyl covered 2" thick urethane foam
- Includes full printed graphics on front panel and school name on side pads
- Includes 4 cup holders and 110v receptacles for electronics
- One hour of free custom artwork; no additional charge when Bison QwikPrint graphic option is selected

1187076	Space Saver Bleacher Model - 46"H	\$3,799 <sup>22</sup> EA	
1187069	Convertible Free Standing Model - 34"H	\$3,399 <sup>22</sup> EA	
1248371	Cover for Convertible Model	\$319 <sup>22</sup> EA	
1248388	Cover for Space Saver Model	\$319 <sup>22</sup> EA	

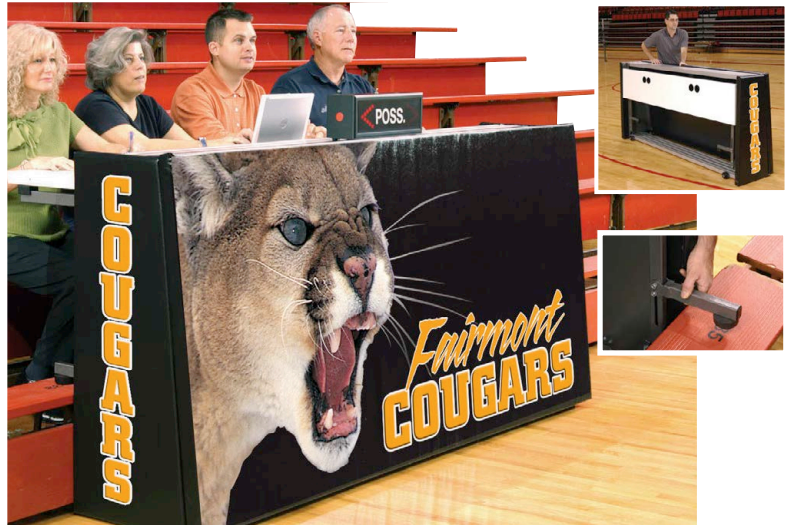

**NEW!**

### LOCKER STOOL

- 18" height, 13" round seat
- 1" thick upholstered seat
- Two color artwork and printing included
- Specify frame color, cushion colors and printing colors
- Minimum of 24 stools
- Delivery 10 - 12 weeks



1292022	10 lbs.	\$99 <sup>22</sup> EA
---------	---------	-----------------------

### ELITE COURT CHAIR

- Features 1" thick backrest and 3" thick seat cushion
- Double tube and channel construction
- Includes 2-color printing in 2 locations and black frame
- Specify cushion color and printing colors
- Minimum order of 24 chairs
- Delivery 10-12 weeks



1237702	\$179 <sup>22</sup> EA
---------	------------------------

### ELITE CUSTOM COURT CHAIRS & 18" locker stool

Frame colors: Black, Grey, Bronze, Garnett, Cobalt, Sand Stone, Arena Red, Forest Green, Royal, Navy, Purple, Bone White, Cocoa Brown, Opal Silver.

Vinyl colors: Black, Cranberry, Red, Patriot Green, Royal, Navy, Purple, White, Yellow.



### SLIPP-NOTT TRACTION SYSTEM

- Used to remove dust, dirt and wax build-up from shoe soles
- Simply walking on it improves traction and maneuverability
- Typical game usage is 2-6 sheets
- Small: 18" x 19" base and (75) - 15" x 18" sheets
- Large: 28" x 29" base and (75) - 26" x 26" sheets

<b>1298673</b>	Small Base & Pad Set	\$141 <sup>22</sup> EA
<b>1298680</b>	Repl. Pad (75 sheets) for Small Set	\$56 <sup>22</sup> EA
<b>1298697</b>	Large Base & Pad Set	\$245 <sup>22</sup> EA
<b>1298703</b>	Repl. Pad (75 sheets) for Large Set	\$99 <sup>22</sup> EA



### BASKETBALL SCOREBOOK

- Includes 30 games, 15 player spots, 3-point scoring, team roster, season schedule, season summary, and simplified scoring instructions
- 8 1/2" x 11" spiral bound with soft cover

**MSBSKBOK** \$6<sup>22</sup> EA

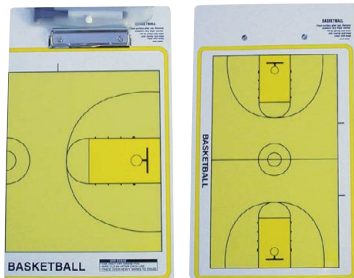

### DOUBLE SIDED BASKETBALL COACH'S BOARD

- 9 1/2" x 15 1/2" dry erase board
- 1/2 court diagram on one side and full court diagram on the other side
- Includes dry erase pen with eraser head and built-in storage pocket

**1235302** Basketball \$16<sup>22</sup> EA ★

### Additional Pens for Coaching Board

- Includes 1 each: Black, Blue, Green and Red

**CBORDPEN** \$8<sup>22</sup> SET



### COURTCLEAN DAMP MOP SYSTEM

- Clean court in minutes
- Improves floor conditions and protects floor finish
- Includes custom sweeper pad, specially designed towel and pull rope
- Works on any hard floor surface

<b>1271058</b>	6' Unit	\$599 <sup>22</sup> EA
<b>1271065</b>	6' Replacement Towel	\$39 <sup>22</sup> EA
<b>1079709</b>	8' Replacement Towel	\$49 <sup>22</sup> EA
<b>1237573</b>	1 gal. Super Shine	\$59 <sup>22</sup> EA

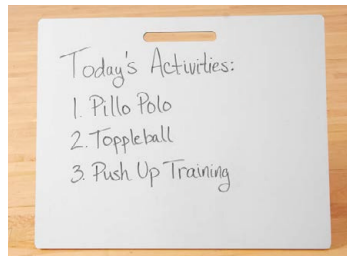

### DRY ERASE BOARD

- Large, portable 24"H x 30"W board
- Use to keep score, as a sign, to explain an activity and more
- Features a cut-out handle for carrying

**1363637** \$44<sup>22</sup> EA ★

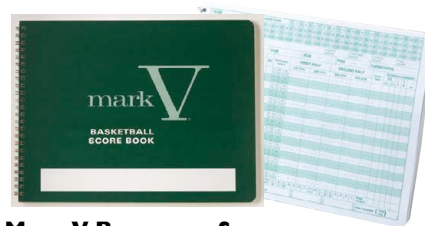

### MARK V BASKETBALL SCOREBOOK

- Includes 30 games, 15 player spots, 3-point scoring, team roster, season schedule, season summary, and simplified scoring instructions
- 8 1/2" x 11" spiral bound with hard cover

**MSMARKBK** \$8<sup>22</sup> EA



### DRY ERASE BOARDS

- Large format enables entire team to see play
- 2 writing surfaces
- Great pen clip with premium dry erase marker
- 1/2 court featured on back of item 1405765 only

<b>1405765</b>	12 1/2"H x 16 1/2"W - 2 lbs.	\$29 <sup>22</sup> EA
<b>1251616</b>	18"H x 23"W - 2.4 lbs.	\$43 <sup>22</sup> EA



### KEYCLEAN PRO

- Clean on the go...play like a pro!
- A large 18" x 24" surface offers full coverage for quick clean-up.
- Highly absorbant, specially designed microfiber pads rapidly absorb sweat and moisture.
- Reduces potential for slip and falls that can cause serious injury.

<b>1383869</b>	Qty 2	\$279 <sup>22</sup> EA
<b>1383870</b>	Microfiber Pads (2)	\$69 <sup>22</sup> EA

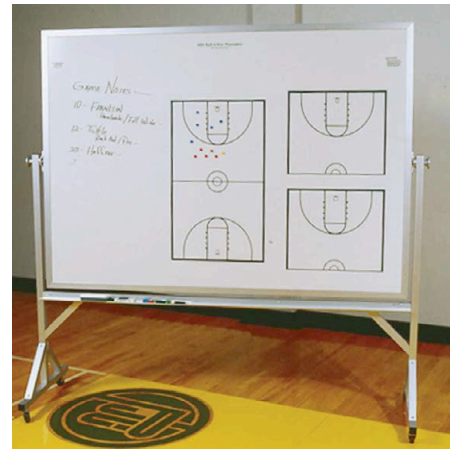

### BASKETBALL PLAYMAKER DRY ERASE BOARDS

- Heavy duty aluminum framed magnetic 48" x 72" dry erase board
- 1 full court and 2 half courts (roll-a-way version has blank space on opposite side)
- Includes (4) dry erase pens, magnetic pieces with vinyl numbering system and an eraser

<b>1298840</b>	Roll-A-Way Version	\$999 <sup>22</sup> EA	
<b>1366512</b>	Wall Mount Version	\$699 <sup>22</sup> EA	

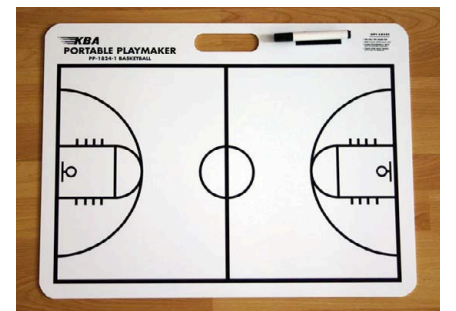

### PORTABLE PLAYMAKER BASKETBALL BOARD

- 18" x 24" durable dry erase board with handle
- Full-court diagram on one side, the other side is a blank, dry erase surface that can be used to flash plays or other information from the sideline
- Includes dry erase pen that attaches to the board

**1299786** \$41<sup>22</sup> EA



### BASKETBALL BUTLER

- Keep basketballs off the ground and ready to use
- Welded steel with powder coated finish
- Attaches to round posts up to 4 1/2" O.D. (hardware included)
- Can also be wall mounted (hardware not included)

1249156	2 Ball	\$59 <sup>22</sup> EA
1253641	4 Ball	\$109 <sup>22</sup> EA



### DOUBLE MONSTER BALL CART

- Fabricated from 1" square steel
- Black powder coated finish
- Holds 30 official size basketballs
- 7 Year Limited Warranty

1162615	30"H x 49"W x 24"D - 54 lbs.	\$429 <sup>22</sup> EA ★
---------	------------------------------	--------------------------



### MONSTER BALL CART

- Fabricated from 1" square steel
- Black powder coated finish
- Holds 15 official size basketballs
- 7 Year Limited Warranty

1162608	30"H x 49"W x 20"D - 30 lbs.	\$299 <sup>22</sup> EA ★
---------	------------------------------	--------------------------



### WALL MOUNT BALL RACK

- Chrome plated 1" steel tubing construction
- Easy to install with 4 screws (not included)
- Will hold up to 18 balls on 3 levels

1197739	40"H x 60"W x 15"D - 18 lbs.	\$154 <sup>22</sup> EA ★
---------	------------------------------	--------------------------



### 15 BALL CART

- Heavy duty chrome steel rods
- Solid triangular frames for strength and stability
- Non-marring casters
- Wide base design prevents tip over
- Holds 15 official size basketballs

1159639	38"H x 51"W x 19"D - 10 lbs.	\$99 <sup>22</sup> EA ★
---------	------------------------------	-------------------------

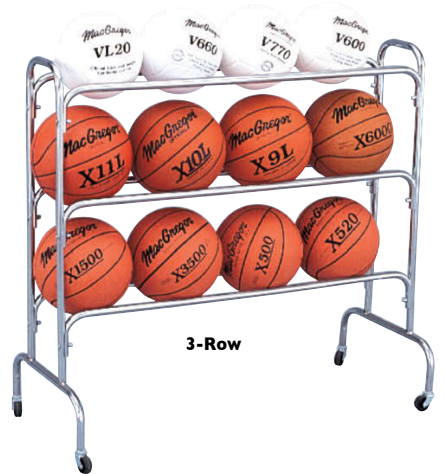

3-Row



### DOUBLE-WIDE STEEL BALL CART

- Made of 1" rugged chrome steel
- Holds 30 full size basketballs
- Comes with heavy duty swiveled rubber casters

1237634	33"H x 45"W x 24"D - 35 lbs.	\$179 <sup>22</sup> EA ★
---------	------------------------------	--------------------------



### HEAVY-DUTY BALL CARTS

- Welded 1" square wall tubing with 3/4" steel chrome plated, ball support arms
- Non-marring, high quality 360° swivel casters
- Extra wide wheel base avoids tipping
- Add a school or mascot name, up to (10) letters, to the end panels (lettering sold separately and is not applied by manufacturer)

#### 5 Year Limited Warranty

Color Options: **Grey, Royal Blue, Scarlet, White.**

1048452	12 Ball Cart	\$349 <sup>22</sup> EA
1048490	18 Ball Cart	\$399 <sup>22</sup> EA
1245899	Lettering	\$69 <sup>22</sup> EA



4-Row

### WIDE BODY BALL CARTS

- Heavy duty chromed steel tubing
- Non-marring, hard rubber casters with a wide, no-topple base
- Designed for easy storage and removal of balls

MCCRT12W	3 Row, 12 Balls	\$69 <sup>22</sup> EA ★
MCCRT16W	4 Row, 16 Balls	\$74 <sup>22</sup> EA ★



### Varsity Toss Back®

- Welded steel frame is equipped with casters for easy movement and can be locked in place with a single hand operated brake lever
- Support post constructed of 2" square steel tubing with a 1 3/4" square telescoping tube for height adjustment
- Height adjusts from 4'5" to 7'4"
- Net frame constructed of 3/4" O.D. steel tubing and measures 38" x 51"
- Overall net dimensions: 27" x 40"
- Net is 2" square mesh made from 3mm braided nylon, secured to frame by (28) specially designed rubber bands

1561XXXX  
20001010

\$999<sup>22</sup> EA



Replacement Net and Bands \$159<sup>22</sup> SET



### Master Toss Back®

- Base frame constructed of 1" O.D. steel tubing and supported by rubber suction cups for stability
- Net frame constructed of 3/4" O.D. steel tubing
- Overall net dimensions: 27" x 36"
- Net is 2" square mesh made from 3mm braided nylon, secured to frame by (22) specially designed rubber bands
- Overall unit size 72"H x 40"W
- Folds closed for easy storage

1271041

\$259<sup>22</sup> EA



## SPALDING

### McCalls Rebounder

- All steel powder coated construction
- Height adjustable from 7' to 10' and moves on smooth rolling casters
- Base is 63" x 39"

1007930

300 lbs.

\$3,199<sup>22</sup> EA



## SKLZ

### D-MAN HANDS UP DEFENDER

- Learn to shoot over or pass around the hands up defender
- Ideal for basketball or football
- Portable, lightweight, sets up and breaks down easily
- Adjustable from 6 1/2' to 8'
- Includes ground stake for use with outdoor sports
- Weighted base for added stability (add water or sand)



1363683

\$59<sup>22</sup> EA



### THE "SHOOTER" RING

- The all steel ring design requires no tools for quick and easy installation
- Attaches to all standard basketball goals to create a smaller diameter rim (17 inches) for improved shooting accuracy

1063732

\$24<sup>22</sup> EA ★



### BALLBACK PRO

- Returns the basketball anywhere in a 90 degree arc without needing adjustment
- Installs in seconds - no tools required

1299816

\$29<sup>22</sup> EA



### DRIBBLE SPECS

- Unique design helps condition players to dribble and handle the ball without looking down
- Does not interfere with shooting

5710XXXX

\$5<sup>22</sup> EA

### BASKETBALL COURT STENCIL

- Create your own regulation basketball court on any permanent surface such as asphalt or concrete
- Meets high school and NCAA specs
- No measuring, just roll out the heavy duty paper sections and use the included paint roller to begin painting (paint not included)



MSBBCSXX

\$39<sup>22</sup> SET

### REBOUND DOME

- Constructed of heavy-duty clear lexan molded plastic
- 7 durable rubber mounts snap on and off for easy installation
- Fits all regulation rims
- 5 year warranty



1298819

\$99<sup>22</sup> EA



**Youth**

**Women's**

**Men's**

### TRICOT MESH REVERSIBLE JERSEY

- 100% polyester 70 denier tricot mesh
- Double thickness body
- Oversized cut with wide shoulder design
- Open bottom for printing

<b>AA560RY</b>	Youth S-L	\$11 <sup>22</sup> EA
<b>AA560R</b>	Men's S-4XL	\$13 <sup>22</sup> EA
<b>AA560RW</b>	Women's S-3XL	\$13 <sup>22</sup> EA

Stock colors:

**Black/White, Dark Green/White, Maroon/White, Navy/White, Purple/White, Royal/White, Scarlet/White**

Non-Stock colors:

**Black/Lt Gold, Black/Orange, Black/Scarlet, Cardinal/White, Col Blue/White, Kelly/White, Lt Gold/White, Maroon/Lt Gold, Navy/Lt Gold, Orange/White, Purple/Lt Gold, Royal/Lt Gold, Royal/Scarlet, Vegas Gold/Navy, Vegas Gold/White**

### TRICOT MESH SHORT

- 100% polyester 70 denier tricot mesh
- Double thickness body
- 1 1/2" covered elastic waistband with inside drawcord

<b>AA566PY</b>	Youth S-L, 6" Inseam	\$11 <sup>42</sup> EA
<b>AA567P</b>	Adult S-XXL, 7" Inseam	\$13 <sup>22</sup> EA
<b>AA569P</b>	Adult S-3XL, 9" Inseam	\$13 <sup>22</sup> EA

CUSTOM SCREEN PRINTING IS AVAILABLE  
TEAM NAMES • SPONSOR LOGOS • NUMBERS  
CALL FOR DETAILS AND PRICING!

### SIZE CHARTS FOR BASKETBALL UNIFORMS

MEN	XS	S	M	L	XL	2XL	3XL	4XL
Chest	32	34-36	38-40	42-44	46-48	50-52	54-56	58-60
Waist	24	26-28	30-32	34-36	38-40	42-44	46-48	50-52
WOMEN	XS	S	M	L	XL	2XL	3XL	
Chest	26	28-30	32-34	36-38	40-42	44-46	46-48	
Waist	18-20	22-24	26-28	30-32	34-36	38-40	40-42	
YOUTH	XS	S	M	L	XL	2XL		
Size	5	6-8	10-12	14-16	18-20	22-24		
Chest	-	28-30	32-34	36-38	40-42	44-46		
Waist	20	20-22	24-26	28-30	32-34	34-36		



### POSITION MATCH WRISTBANDS

- Includes 5 pair of wrist bands, each pair a different color
- The player guards the player on the other team that is wearing the same colored wrist band
- Great aide for younger players to remember who they are guarding
- Use colors to rank skill level to ensure even matchups

**I296754** \$8<sup>22</sup> EA



### REFEREE/OFFICIALS JERSEY

- 100% polyester in alternating colors-Black and White
- Black v-neck collar and sleeve trim
- Hemmed straight bottom

<b>I157673</b>	M-XL	\$26 <sup>22</sup> EA ★
<b>I157703</b>	XXL	\$27 <sup>22</sup> EA ★
<b>I157710</b>	XXXL	\$29 <sup>22</sup> EA ★



### PRO-DOWN

#### OFFICIALS JERSEY

- 100% polyester
- Styled with zipper and 1 1/4" black cuff on sleeve end

<b>C58</b>	M-XL	\$29 <sup>22</sup> EA ★
<b>C58XXLXX</b>	XXL	\$30 <sup>22</sup> EA ★
<b>C58XXXLG</b>	XXXL	\$31 <sup>22</sup> EA ★



AVAILABLE IN  
**HOME**  
**AWAY**



### EXTREME MESH JERSEY/SHORT

100% eXtreme plaited Cationic polyester with moisture management fibers. Curved shoulder inserts to improve fit and movement. Entire jersey is top stitched for durability, appearance, and comfort. Jersey is NFHS legal. 1.5-inch covered elastic waistband, inside drawcord. Adult graduated inseams: S-M 9-inch, L-3XL 10-inch. Youth inseams: S-M 7-inch, L-XL 8 in.

AA535Y	Youth Jersey S-XL	\$14 <sup>22</sup> EA
AA535J	Men's Jersey S-3XL	\$19 <sup>22</sup> EA
AA535PY	Youth Short S-XL	\$14 <sup>22</sup> EA
AA535P	Men's Short S-3XL	\$19 <sup>22</sup> EA



### MUSCLE JERSEY

100% polyester, DRI GEAR. Interlock fabric has a silky smooth feel. Lightweight and snag resistant. Contrasting mitered V-neck collar.

1382237	Youth YS-YXL	\$14 <sup>22</sup> EA
1382310	Women's Sizes: S-2XL	\$14 <sup>22</sup> EA
1382128	Men's S-3XL	\$14 <sup>22</sup> EA



### MUSCLE SHORT

100% polyester, DRI GEAR. Interlock fabric has a silky smooth feel. Lightweight and snag resistant. 2-inch drawcord.

1382511	Youth YS-YXL	\$12 <sup>22</sup> EA
1382402	Adult S-3XL	\$12 <sup>22</sup> EA



### CLUTCH REVERSIBLE JERSEY

100% polyester, DRI GEAR. Interlock fabric has a silky smooth feel. Lightweight and snag resistant. Double needle hems, allows decorating options.

1382645	Youth YS-YXL	\$14 <sup>22</sup> EA
1382584	Adult S-3XL	\$14 <sup>22</sup> EA



### CLUTCH SHORT

100% polyester, DRI GEAR. Interlock fabric has a silky smooth feel. Lightweight and snag resistant. Double needle hems, 2" elastic waistband with drawstring.

1382947	Youth YS-YXL	\$12 <sup>22</sup> EA
1382686	Adult S-3XL	\$12 <sup>22</sup> EA

## STOCK JERSEYS



# TEAM NBA.

PLAYERS. TEAMS. DREAMS.



SHIPS IN 24 HR

### NBA REPLICA JERSEYS

- 100% colorfast polyester Double ply, eXtreme tear drop fully reversible jersey-soft, cool, lightweight mock mesh material
- Open hemmed bottom for decoration
- Authentic NBA logos on center front and reverse side
- NBA logoman on upper left side and NBA woven jock tag for identification

ANBAY Youth S-L \$18.99 EA

ANBAA Adult S-XL \$20.99 EA



### NON-STOCK JERSEYS



2 WEEK DELIVERY



### NBA REPLICA SHORTS (BLANK)

- 100% colorfast polyester solid color single ply short
- 1.5" exposed elastic waistband, inside drawcord
- Cover hemmed leg openings
- Inseams: Adult S-XL (9"), Youth Small (7"), Youth Medium (8"), Youth Large (9")

Color Options: **Black/Scarlet, Black/White, Kelly/White, Navy/White, Purple/Lt Gold, Orange/White, Royal/Orange, Royal/White, Scarlet/White, Thunder Blue/Navy**

A205Y Youth S-L \$11.99 EA  
A205A Adult S-XL \$12.99 EA



#### SIZE CHARTS FOR BASKETBALL UNIFORMS

MEN	S	M	L	XL
<b>CHEST</b>	34-36	38-40	42-44	46-48
<b>WAIST</b>	26-28	30-32	34-36	38-40

YOUTH	S	M	L
<b>SIZE</b>	6-8	10-12	14-16
<b>CHEST</b>	28-30	32-34	36-38
<b>WAIST</b>	20-22	24-26	28-30

### NUMBERING

FULL BLOCK NUMBERS CAN BE ADDED TO ANY NBA JERSEY!

# 41

## COMPOSITE FOOTBALLS



**MacGregor**

**COMPOSITE SERIES**

- Composite leather construction
- Tackified cover for superior grip control
- Double leather laced for additional control
- Nylon wound carcass provides superior shape and air retention

<b>1227697</b>	Official Size	\$21 <sup>22</sup> EA ★
<b>1227680</b>	Youth, 12-14	\$20 <sup>22</sup> EA ★
<b>1227673</b>	Junior, 9-12	\$19 <sup>22</sup> EA ★
<b>1227666</b>	Pee Wee, 6-9	\$18 <sup>22</sup> EA ★



**NFHS**  
APPROVED

**V-FLIGHT AIRLOCK COMPOSITE**

- Built for high-performance feel and precision flight
- High-grip premium synthetic leather
- Industry-leading airlock technology retains air pressure
- QB-preferred shape developed to fit perfectly in the hand
- Innovative textured half stripe for enhanced touch
- Engineered high-grip lacing system for maximum control

<b>1371492</b>	Official Size	\$49 <sup>22</sup> EA
----------------	---------------	-----------------------



**NFHS**  
APPROVED

**SPIRAL-TECH 3.0 COMPOSITE SERIES**

- Composite leather construction, high-tack finish
- Full nylon-wound butyl bladder
- Exceptional air and shape retention for consistent flight and accuracy
- Official size is NFHS approved

<b>NKFT0231</b>	Official Size	\$24 <sup>22</sup> EA
<b>NKFT0232</b>	Youth, 12-14	\$24 <sup>22</sup> EA
<b>NKFT0233</b>	Junior, 9-12	\$24 <sup>22</sup> EA
<b>NKFT0234</b>	Pee Wee, 6-9	\$24 <sup>22</sup> EA



**Rawlings**

**NFHS**  
APPROVED

**ST5 COMPOSITE SERIES**

- Exclusive mottled composite leather for leather game ball look
- Thick gauge soft touch sueded lace
- Unique 3-ply laminated lining offers better control and a sure grip
- Official size is NFHS approved

<b>1059281</b>	Official Size	\$34 <sup>22</sup> EA
<b>1059250</b>	Youth, 12-14	\$32 <sup>22</sup> EA
<b>1059267</b>	Junior, 9-12	\$30 <sup>22</sup> EA
<b>1059274</b>	Pee Wee, 6-9	\$27 <sup>22</sup> EA



**Wilson**

**GST COMPOSITE SERIES**

- Premium composite leather construction with high definition pebble
- ACL lacing system provides better grip
- New football with popular lighter color GST look

<b>1297287</b>	Official Size	\$39 <sup>22</sup> EA
<b>1297294</b>	Youth, 12-14	\$36 <sup>22</sup> EA
<b>1297300</b>	Junior, 9-12	\$35 <sup>22</sup> EA
<b>1297317</b>	Pee Wee, 6-9	\$35 <sup>22</sup> EA



**Wilson**

**NFHS**  
APPROVED

**TD COMPOSITE SERIES**

- Premium composite leather construction with high definition pebble
- ACL lacing system for better grip and control
- Official size is NFHS approved

<b>1239454</b>	Official Size	\$35 <sup>22</sup> EA
<b>1239461</b>	Youth, 12-14	\$33 <sup>22</sup> EA
<b>1239478</b>	Junior, 9-12	\$32 <sup>22</sup> EA
<b>1239485</b>	Pee Wee, 6-9	\$32 <sup>22</sup> EA



**POP WARNER COMPOSITE SERIES**

- UA 495 with GRIPSKIN technology ensures ultimate tack and grip
- Proprietary lace that retains grip characteristics dry or wet

<b>1375491</b>	Youth 11 - 14	\$29 <sup>22</sup> EA
<b>1375492</b>	Junior 9 - 11	\$29 <sup>22</sup> EA
<b>1375493</b>	Pee Wee 7 - 9	\$29 <sup>22</sup> EA



**AUTOGRAPH FOOTBALL**

- Synthetic leather (PVC) cover
- For display purposes ONLY
- 3 white panels for autographs

<b>1072518</b>	Official Size	\$19 <sup>22</sup> EA ★
----------------	---------------	-------------------------

## LEATHER FOOTBALLS



**NFHS**  
APPROVED

**695XT OFFICIAL**

- Xtra Tacky leather with High Profile PU lace
- Rubberized stitching creates Traxxion™ Zone around stripes
- Pebbled logos for a more uniform surface
- Smallest legal girth
- 2-ply water-resistant liner

<b>1384318</b>	Official Size	\$79 <sup>22</sup> EA
----------------	---------------	-----------------------

**LEATHER FOOTBALLS**

**MX LEATHER SERIES**

- Horween® Leather construction
- Tanned-N-Tack Leather for improved grip
- Rubberized laces for improved grip
- Water resistant lining
- 4-Ply TPU Bladder for better air retention
- Official size is NFHS Approved

<b>1384386</b>	Official Size	\$49 <sup>22</sup> EA ★
<b>1384387</b>	Youth, 12-14	\$43 <sup>22</sup> EA ★
<b>1384388</b>	Junior, 9-12	\$41 <sup>22</sup> EA ★
<b>1384389</b>	Pee Wee, 6-9	\$39 <sup>22</sup> EA ★



**NFHS**  
APPROVED

FOOTBALL

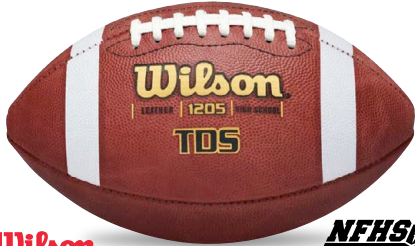

**Wilson**

**NFHS**  
APPROVED

**TD LEATHER SERIES**

- Wilson 899 WE Leather Lockstich construction with TD series pattern preferred by high schools
- Patented ACL™ Lacing System with dual sided lace re-inforcers
- Wilson® exclusive grip stripes
- Official size is NFHS approved

<b>3FI205R</b>	Official Size	\$79 <sup>22</sup> EA
<b>3FI300</b>	Youth, 12-14	\$49 <sup>22</sup> EA
<b>3FI360</b>	Junior, 9-12	\$46 <sup>22</sup> EA
<b>3FI382B</b>	Pee Wee, 6-9	\$44 <sup>22</sup> EA



**Wilson**

**NFHS**  
APPROVED

**FI005 NCAA OFFICIAL**

- Exclusive 899 WE leather construction
- 1005 "Small" pattern-with ACL lacing, dual sided lace re-inforcers with grip stripes
- Multi-layered lining and 3-ply bladder
- Collegiate pattern

<b>3FI005R</b>	Official Size	\$85 <sup>22</sup> EA
----------------	---------------	-----------------------



**Wilson**

**NFHS**  
APPROVED

**GST LEATHER SERIES**

- Wilson 863 WE leather construction with tanned-in tack, deeper pebble and firmer texture
- Exclusive sewn in grip stripes are 82% more grippable than painted on stripes
- ACL Lacing with dual sided lace re-inforcers
- Official size is NFHS approved

<b>3FI003</b>	Official Size	\$89 <sup>22</sup> EA
<b>1167931</b>	Youth, 12-14	\$57 <sup>22</sup> EA
<b>1167939</b>	Junior, 9-12	\$52 <sup>22</sup> EA
<b>1167948</b>	Pee Wee, 6-9	\$49 <sup>22</sup> EA
<b>1014082</b>	Official P3 Practice	\$64 <sup>22</sup> EA



**SPALDING**  
**J5V SILVER**

**NFHS**  
APPROVED

- Select grain Horween leather construction
- TPR composite laces
- 4-ply TPU bladder for improved air retention
- Water resistant liner
- Varsity pattern

<b>1159691</b>	Official Size	\$55 <sup>22</sup> EA
----------------	---------------	-----------------------



**SPALDING**  
**J5V ADVANCE**

**NFHS**  
APPROVED

- SBR Foam backing for softer feel and improved handling
- Rubberized laces with diamond cross weave design for improved grip
- 4-ply water resistant liner maintains weight consistency in all weather conditions

<b>1419983</b>	Official Size	\$79 <sup>22</sup> EA
----------------	---------------	-----------------------



**SPALDING**  
**ALPHA**

**NFHS**  
APPROVED

- Horween® "S" tack leather cover for improved grip
- Boxed sewn strip for easy point of reference
- Raised diamond lace for better grip
- Hartco liner for the best shape retention
- Two-Ply TPU bladder for consistent air retention

<b>1388060</b>	Official Size	\$89 <sup>22</sup> EA
----------------	---------------	-----------------------



**Rawlings**  
**ST5 OFFICIAL**

**NFHS**  
APPROVED

- Deep pebbled Horween leather construction
- Thick gauge soft touch sueded lace
- Unique 3-ply laminated lining offers better control and a sure grip
- QB 12 pattern

<b>1059236</b>	Official Size	\$79 <sup>22</sup> EA
----------------	---------------	-----------------------



**Rawlings**  
**R2 OFFICIAL**

**NFHS**  
APPROVED

- Aerial Pattern
- R-Grip Composite Stripes
- Enhanced tack center cut Horween leather
- Rawlings R-Grip rubberized lace
- Soft Touch Technology

<b>1388069</b>	Official Size	\$89 <sup>22</sup> EA
----------------	---------------	-----------------------



**NIKE**  
**VAPOR ONE SERIES**

**NFHS**  
APPROVED

- Used by over 30 DI college programs
- Custom crafted premium tacky leather for a broken-in feel
- Innovative stitched-in TEXTURED half stripe to deliver the perfect feel to every quarterback
- A superior combination of shape and feel

<b>1371491</b>	Official Size	\$89 <sup>22</sup> EA
<b>1377068</b>	Youth, 12 - 14	\$79 <sup>22</sup> EA
<b>1377069</b>	Junior, 9 - 12	\$79 <sup>22</sup> EA

## RUBBER FOOTBALLS



### Voit

#### ENDURO RUBBER FOOTBALL w/STITCHED LACES

- Pebble grained sewn rubber panels
- Composite stitched laces
- Butyl bladder for better shape and air retention
- Plays and feels better than a molded rubber ball

1376978	Official Size	\$16 <sup>22</sup> EA ★
1376979	Youth Size, 12-14	\$15 <sup>22</sup> EA ★
1376980	Junior, 9-12	\$14 <sup>22</sup> EA ★



### MacGregor

#### RUBBER FOOTBALL

- Pebble grained exterior
- Raised molded laces and simulated seams
- All weather, all surface play

MCX2LXXX	Official Size	\$11 <sup>22</sup> EA ★
MCX2YXXX	Youth, 12-14	\$10 <sup>22</sup> EA ★
MCX2JXXX	Junior, 9-12	\$9 <sup>22</sup> EA ★



### Voit

#### PLAYGROUND TOUGH RUBBER FOOTBALL

- Pebble grained exterior
  - Raised molded laces and simulated seams
  - All weather, all surface play
- 2 Year Limited Warranty**

VCF9SHXX	Official Size	\$13 <sup>22</sup> EA ★
VCF7SHXX	Youth, 12-14	\$12 <sup>22</sup> EA ★
VCF6SHXX	Junior, 9-12	\$11 <sup>22</sup> EA ★
VCF5SHXX	Pee Wee, 6-9	\$10 <sup>22</sup> EA ★



### Voit

#### XF9 SUPER-DUTY FOOTBALL

- Pebble grained rubber exterior
  - Two rows of raised, synthetic leather laces
  - All weather, all surface play
- 2 Year Limited Warranty**

VXF9SXXX	Official Size	\$18 <sup>22</sup> EA ★
----------	---------------	-------------------------

**NEW!**

#### QB TEE FOOTBALL DRILL TEE

- Countdown timer begins when ball is lifted from tee
- Adjustable timer with audible beep
- Designed for indoor or outdoor use

1083873 \$149<sup>22</sup> EA

### Wilson

#### GAME BALL PREP KIT

- Conditions leather for maximum tack and extended use of game balls
- Wax bar lasts longer for frequent use
- Durable brush withstands rough application and buffing

1375489 \$27<sup>22</sup> EA

### Wilson

#### TR RUBBER SERIES

- All weather sponge-rubber cover
- Double laced

1326062	Official Size	\$22 <sup>22</sup> EA
1325942	Youth, 12-14	\$21 <sup>22</sup> EA
1325959	Junior, 9-12	\$19 <sup>22</sup> EA



#### KICKOFF TEE

- Universal style rubber kicking tee

1405560	1 in.	\$4 <sup>22</sup> EA
MSKICKOF	2 in.	\$4 <sup>22</sup> EA ★



#### SOCCER STYLE KICKING TEE

- Unique design allows soccer style kickers to make contact with the ball first, instead of the tee
- Weighted for stability

MSSKTRFX	Right Footed Kicker	\$4 <sup>22</sup> EA ★
MSSKTLFX	Left Footed Kicker	\$4 <sup>22</sup> EA ★



#### GROUND ZERO KICKING TEE

- Heavy duty black rubber tee
- 1" includes on-side kick feature; 2" does not
- Used by NFL Super Bowl teams

FBGZ1	1"	\$24 <sup>22</sup> EA ★
1405590	2"	\$29 <sup>22</sup> EA

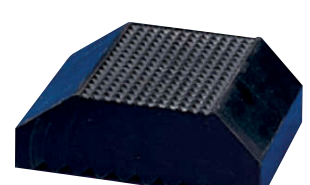

#### PLACEKICK TEE

- Heavyweight black rubber tee
- Serrated bottom for holds on grass or turf

1405565	1 in.	\$4 <sup>22</sup> EA
MSPATXXX	2 in.	\$4 <sup>22</sup> EA ★



#### WIZARD KICKING STIX FOOTBALL HOLDER

- Durable powder coated steel and aluminum construction
- Riveted legs for easy, quick fold-up design
- Works with or without place kick block
- Football sold separately

1363687 \$32<sup>22</sup> EA

### SKLZ

#### UNIVERSAL 4-IN-1 KICKING TEE

- Durable rubber with multiple height configurations
- Gripping notches hold the ball firmly in place
- Use as a 1" or 1.75" kick-off tee for regular/onside kicks or as 1" or 1.75" place kicking tee

1384285 \$19<sup>22</sup> EA

### Wilson

#### PRO KICK

- Collapsible sturdy all-metal construction
- Holds any size football to the desired angle
- Works with or without kicking tee
- Football sold separately

1008579 \$31<sup>22</sup> EA



**BSNSPORTS**

**FOOTBALL STAT BOOK**

- Simplified instructions for charting offensive and defensive plays
- 11 game stat book with 24 play charts per quarter

1197631 \$5<sup>99</sup> EA



**FOOTBALL BALL BAG**

- Holds 12 official size footballs
- Heavy-duty 600 Denier polyester construction with rugged nylon zipper with wrap around handles and shoulder strap
- Interior dividers separate dry from wet footballs
- Includes zippered pockets on both ends for extra storage
- Available in Black only

1377679 16"H x 24"W x 36"L \$69<sup>99</sup> EA ★



**JUGS**

**FOOTBALL PASSING MACHINE**

- Solid steel and cast aluminum construction
- Powered by 110 Volt AC or 1000-watt generator
- Throws footballs 5 - 80 yards and up to 7.5 sec. hang time
- Throws perfect spiral passes or punts and end-over-end kicks
- Dial setting speed adjustment
- Unit swivels 360 degrees and includes transport wheel

**5 Year Limited Warranty**

1159226 127 lbs. \$2,899<sup>99</sup> EA



**JUGS**

**FIELD GENERAL FOOTBALL PASSING MACHINE**

- Solid steel and cast aluminum construction
- Powered by 110 Volt AC or 1000-watt generator
- Throws footballs 5 - 50 yds and up to 5 sec. hang time
- Throws perfect spiral passes, punts or kicks
- Dial setting speed adjustment
- Unit swivels 360 degrees and includes transport wheel

**5 Year Limited Warranty**

1276848 94 lbs. \$2,399<sup>99</sup> EA 



**FISHER**

**CART FOR JUGS FOOTBALL PASSING MACHINES**

- Allows for convenient transport of your JUGS throwing machine
- Pneumatic tires allows for easy relocation without damaging your turf
- Front two wheels swivel 360 degrees for easy maneuverability
- T-bar handle located on front of cart

1376901 32"W x 62"L - 125 lbs. \$749<sup>99</sup> EA 



**PRO-DOWN**

**SNAPPER STICK**

- Aluminum pole with foam rubber football
- Teach players to react to ball movement not cadence
- Telescoping aluminum pole extends from 30" to 60"
- Allows coach to stand instead of kneeling

1299939 \$45<sup>99</sup> EA ★



**KBA**

**FOOTBALL PLAYMAKER**

- 18"H x 24"W dry erase coaching board with handle
- Football field on one side with play diagrams on other side
- Includes dry-erase pen that attaches to the board with Velcro

1299793 \$42<sup>99</sup> EA



**Sport Write!**  
COACHING TOOLS

**DRY-ERASE BOARDS**

- Large format enables entire team to see play
- 2 writing surfaces
- Includes pen clip with dry erase marker

1405760 12.5"H x 16.5"W - 2lbs. \$29<sup>99</sup> EA  
1251623 18"H x 23"W - 2.4lbs. \$43<sup>99</sup> EA



**DOUBLE SIDED COACH'S BOARD**

- 9.5" x 15.5" dry-erase board
- Field diagram on one side and play diagrams on the other side
- Includes dry-erase pen with eraser head and built-in storage pocket

1240061 Football \$15<sup>99</sup> EA ★



**FISHER**

**BULL SLED**

- **Blocking Units:** Sturdy metal pedestal mounted to powder coated steel frame. Torso pad with hand engagement area mounts to the pedestal on a 3" X 3" steel post that telescopes into the fulcrum mechanism. Spring tension can be adjusted through the full range of motion.
- **Modular Construction:** Individual components allow stations to be added as the need arises or budget permits. Start with 1 or 2 Man Sled and easily expand as desired.
- The BULL Sled teaches players to roll their hips to maximize power and drive through opponents. 42" H Pads lock down for drive blocking.
- Please specify pad color: Black, Red, Royal or Gold only.

**5 Year Limited Warranty**

I271249	Single	\$1,899 <sup>92</sup> EA	
I271256	2 Man	\$3,299 <sup>92</sup> EA	
I271263	3 Man	\$4,499 <sup>92</sup> EA	
I271270	4 Man	\$5,699 <sup>92</sup> EA	
I271287	5 Man	\$6,899 <sup>92</sup> EA	
I271294	6 Man	\$8,099 <sup>92</sup> EA	
I271300	7 Man	\$9,399 <sup>92</sup> EA	



**PRO-DOWN**

**COLLEGIATE ADD-A-CHUTE**

**LINEMAN CHUTES**

- **Varsity Model:** Heavy-walled 1 5/8" powder coated steel tubing. Entrance height is fixed at 40" and exit height is fixed at 48" Assembled dimensions: 50"L x 50"W. Includes hardware to link multiple chutes together.
- **Collegiate Model:** Heavy-walled 2" galvanized steel. Assembled dimensions - 45"H entry x 52"H exit x 4.5"W x 5"D. (Non-adjustable) Unique "Add-a-Chute" feature allows expansion from a one-man to a seven-man system.

**FBCCHUTE**

I272987  
I272994

Varsity Model (1 Chute)  
Collegiate Model (1 Chute)  
Collegiate Model Add-a-Chute

\$175<sup>92</sup> EA   
\$259<sup>92</sup> EA   
\$194<sup>92</sup> EA



**VARSITY**

**FISHER**

**POP-UP DUMMY**

- Three-layer 18 oz. vinyl covered high impact foam construction
- Weighted rubber coated base allows dummy to "pop" back up after contact
- Includes 4 carry handles
- Please specify color (see below for choices)

**Color Options: Black, Forest Green, Gold, Grey, Kelly Green, Maroon, Navy, Orange, Purple, Royal, Scarlet.**

I240153	Junior - 45" X 24" - 80 lbs.	\$459 <sup>92</sup> EA	
I240160	Varsity - 60" X 24" - 115 lbs.	\$579 <sup>92</sup> EA	
I240177	Pro - 72" X 24" - 125 lbs.	\$659 <sup>92</sup> EA	



**PRO-DOWN**

**ADJUSTABLE LINEMEN SPLIT MARKER**

- Heavy-duty vinyl construction with weights at the ends and center to keep it flat on the ground
- The labeled removable positions attach to a hook-and-loop fastening strip to customize formations
- 39"L overall, 10.5"W black strip with 36"L yellow position indicators labeled with 9"H letters
- Great for teaching linemen and backs splits and gaps

200234007

\$165<sup>92</sup> EA ★

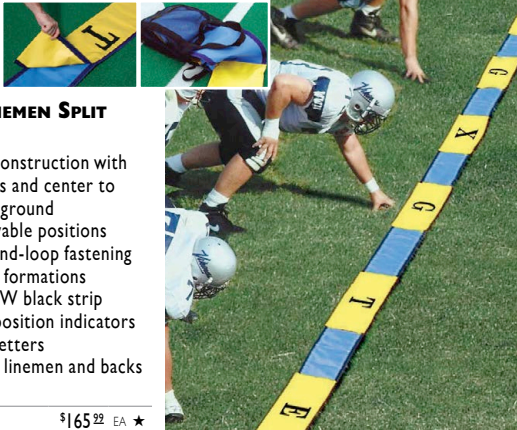

**FISHER**

**FOLDING CHUTE BOARD**

- High impact foam covered with 18 oz. vinyl
- Helps teach players to stay in blocking lanes
- Folds in half and includes handles

I291803

Yellow Only - 2"H x 12"W x 96"L

\$119<sup>92</sup> EA



Sold Separately

**FISHER**

**AGILITY HOOP**

- Practice getting off the line and around the corner
- Made of sturdy PVC piping
- Assembles in seconds

I344158 12' Dia Hoop \$95<sup>92</sup> EA

**IMPACT BALL**

- Helps teach proper footwork and handwork
- Practice defending against opponent getting into knees
- Weighs 40 lbs. for impact resistance

I344165 36" Dia Ball \$359<sup>92</sup> EA



**REACTOR**  
CHAMPION BARBELL

**FIXED RUNG AGILITY LADDER**

- Ideal for developing quick and accurate foot speed, increased balance and coordination
- Each ladder is 15'L x 20"W with ten sections
- Rugged 1" wide webbing with end buckles allow various shape configurations for a more diversified workout
- Connecting buckles allow for additional ladders for longer runs and different formations
- Includes carry bag

1248548 \$44<sup>22</sup> EA ★



**REACTOR**  
CHAMPION BARBELL

**BLASTER POWER SLED**

- Increase speed, explosion, leg strength and endurance
- Made of 11 gauge durable black powder coated steel, skis are 1/4" solid steel
- Closed end rubber grips on low push handles, and capped large push handles accommodate standard 2" Olympic plates (sold separately - see page 239)
- Optional waist and shoulder harness is fully adjustable with quick release attachment and double safety tethers
- 37"H x 46"W x 40"L - 60 lbs.

1377172 Sled Only \$299<sup>22</sup> EA  
1240054 Harness and Tether Only \$44<sup>22</sup> EA ★



FOOTBALL

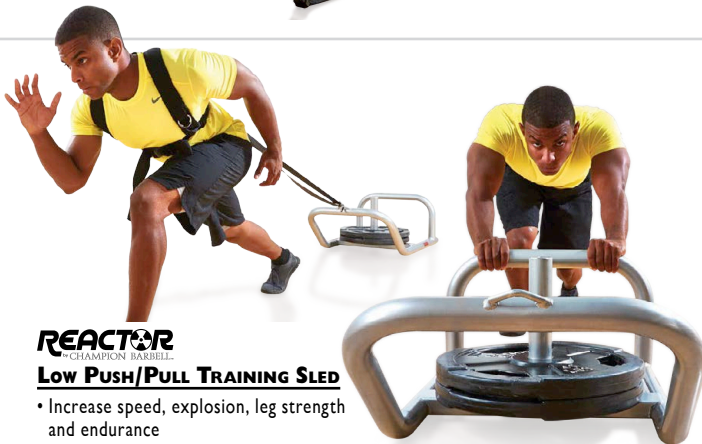

**REACTOR**  
CHAMPION BARBELL

**LOW PUSH/PULL TRAINING SLED**

- Increase speed, explosion, leg strength and endurance
- Large radius handle allows for multiple grip locations
- 12"H x 2" O.D. post will hold up to 315 lbs. of Olympic plates (sold separately - see page 247)
- One piece welded construction, 1.9" silver powder coated steel tubing
- Waist and shoulder harness is fully adjustable with quick release attachment and double safety tethers
- 14"H x 23"W x 38"L - 25 lbs

1375098 Sled and Harness \$249<sup>22</sup> EA ★  
1375084 Sled Only \$209<sup>22</sup> EA ★  
1240054 Harness and Tether Only \$44<sup>22</sup> EA ★

**WILDER**  
FITNESS

**BIG HANDLE PUSH SLED**

- Constructed from 2" channel round schedule 40 tubular steel for maximum durability
- Angled front end for lifting drives and multiple grip locations at the rear for technique variations
- Includes 2 - 14" weight horns
- For use on grass or turf surface only
- Specify color when ordering

1375098 36"H x 22"W x 48"L - 95 lbs. \$499<sup>22</sup> EA ★

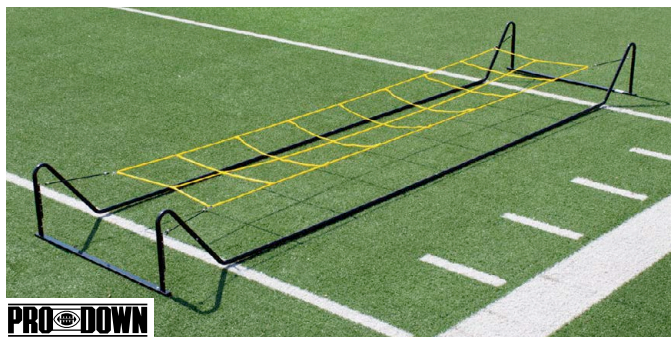

**PRO-DOWN**  
RUNNING ROPES

- Frame constructed of powder-coated 17-gauge steel tubing
- Exclusive frame design keeps all tubing safely away from the training path
- Optic yellow nylon step grid is 14' 10"L x 3' 3"W
- Frame dimensions: 18' 6"L x 4' 6"W, grid adjusts from 6" to 15" H
- Step grid connects to frame with bungee cords

1201987 Complete Unit \$249<sup>22</sup> EA ★  
1201994 Replacement Running Grid \$74<sup>22</sup> EA ★

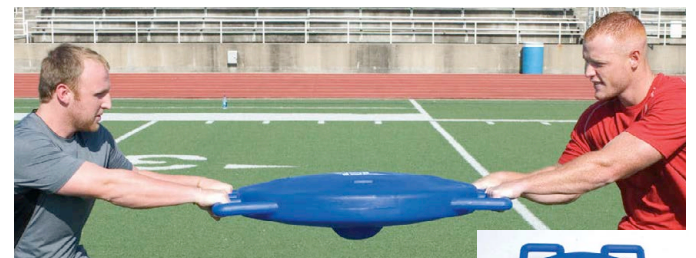

**THE TUG**

- Use water for adjustable weight up to 140 lbs; provides a wide variety of activities including tug-of-war, weight training, use as a sled, as an anchor for sit-ups, overhead for lunges, and much more
- Water movement creates inertia that requires compensation for core body work
- 8"H x 30"W x 36"L - 15 lbs. empty
- Color options: Black, Green, Light Blue, Maroon, Orange, Purple, Red, Royal, Yellow

1301908 Specify Color \$299<sup>22</sup> EA



**PRO-DOWN DUMMIES & PADS**



**POWER DRIVER INDOOR BLOCKING SLED**

The Power Driver is the perfect product for your football field house or weight room. Keep the team's technique sharp while conditioning specifically targeted muscle groups on season or off season. Helps develop quickness, hand placement and strength. Players can strike the Man Pad at the arm pits which are perfectly located at 16" wide, 37" high at a 65 degree angle. Lift the Pivot Arm 14" while driving the 85 lb. Carriage up a 5 degree incline for 60" of travel.

**FEATURES:**

- 2" x 3" steel tubing frame with Silver & Black Powder Coated Finish
- Carriage glides freely on 6 precision bearing polyurethane wheels with sound deadening bump stops
- Increase resistance by adding up to 135 lbs. to the pivot arm and/or adding up to 360 lbs. to the carriage
- Man Pad is 6" thick urethane foam covered in 18 oz. blue vinyl
- Unit must be anchored to the ground
- Easily removable Man Pad so unit can be used for additional drills

**1375101** 92"L x 56"W x 51"H - 387 lbs. \$1,999<sup>22</sup> EA ★ **S&H**

**PRO-DOWN**

- Double-reinforced 18 oz. vinyl shell
- Black in stock\*
- Durable foam interior
- 4-6 weeks for custom colors



**MAN SHIELD**

• 22"W x 26"L x 5"H - 5 lbs.; 4 reinforced handles

**1384302** Royal \$99<sup>22</sup> EA ★  
**1384303** Black \$99<sup>22</sup> EA ★



**PRO SHIELD**

• 16"W x 42"L x 4"H - 5 lbs.; 2 reinforced handles

**200234411** Black \$79<sup>22</sup> EA ★  
**FBDMPROX** Custom Color \$109<sup>22</sup> EA



**COLLEGIATE SHIELD**

• 16"W x 26"L x 6"H - 4 lbs.; 2 reinforced handles

**200232811** Black \$72<sup>22</sup> EA ★  
**FBDMCOLX** Custom Color \$99<sup>22</sup> EA



**FOREARM SHIVER PADS**

- 24" x 11.5" x 3"
- Shock foam pad with nylon-reinforced cover
- Protects hand and forearm area

**200232411** Black \$33<sup>22</sup> EA ★  
**FBDMSHIV** Custom Color \$56<sup>22</sup> EA

**CUSTOM COLOR CHOICES:** Choose from 12 school colors, in solids or alternating panel colors. Due to dye lots and natural variations, vinyl colors may vary slightly if ordered at separate times.

**Black**

**Columbia**

**Dark Green**

**Grey**

**Kelly**

**Maroon**

**Navy**



**PRO-DOWN** DUMMIES & PADS



- Double-reinforced 18 oz. vinyl shell
- Durable foam interior
- Black in stock\*
- 4-6 weeks for custom colors



**ROUND BLOCKING DUMMY**

- 2 reinforced handles

<b>20023500I</b>	14"W x 50"L - 13 lbs. - Black	\$149 <sup>22</sup> EA ★
<b>FBDMI4RDDS</b>	14"W x 50"L - 13 lbs. - Custom Color	\$229 <sup>22</sup> EA
<b>20023531I</b>	13"W x 38"L - 10 lbs. - Black	\$129 <sup>22</sup> EA ★

**HEAVY ROUND BLOCKING DUMMY**

- 3 reinforced handles

<b>200235100</b>	14"W x 50"L - 21 lbs. - Black	\$189 <sup>22</sup> EA ★
<b>FBDM22RD</b>	14"W x 50"L - 21 lbs. - Custom Color	\$299 <sup>22</sup> EA



**STEP-OVER DUMMIES**

- Handles on ends and bottom

<b>20023081I</b>	17"B x 8"H x 51"L - 10 lbs. - Black	\$114 <sup>22</sup> EA ★
<b>FBSTEP8X</b>	17"B x 8"H x 51"L - 10 lbs. - Custom Colors	\$169 <sup>22</sup> EA
<b>20023121I</b>	17"B x 12"H x 51"L - 20 lbs. - Black	\$155 <sup>22</sup> EA ★
<b>FBSTEP12</b>	17"B x 12"H x 51"L - 20 lbs. - Custom Colors	\$239 <sup>22</sup> EA



**SQUARE BLOCKING DUMMY**

- 2 reinforced handles

<b>200235012</b>	14"W x 50"L - 15 lbs. - Black	\$149 <sup>22</sup> EA ★
<b>FBDMI4SQ</b>	14"W x 50"L - 15 lbs. - Custom Color	\$209 <sup>22</sup> EA



**REPLACEMENT DUMMIES FOR OUTDOOR SLEDS**

- Polyurethane foam filling covered with durable 18 oz. vinyl
- Seams are double stitched with heavy-duty nylon thread for added durability
- Cone pad only includes handles to allow for dummy use without sled
- Cone and Man pad in stock in Royal Blue only
- Cone pad dimensions: 48"H x 18" Top Diam x 13" Bottom Diam
- Man Pad dimensions: 48"H x 28"W x 10"D
- Other colors available for special order. Please call for details

<b>1296259</b>	Pro Pad - Royal Only	\$399 <sup>22</sup> EA ★	
<b>1243994</b>	Cone Pad - Royal Only	\$399 <sup>22</sup> EA ★	

Orange      Purple      Red      Royal      Tan      White      Yellow

## PRO-DOWN BLOCKING SLEDS



Attachment Chain



Coaches Platform



Spring Design Licensed From Marty Gilman, Inc.

### Varsity M-Series Blocking Sleds

- All steel powder coated frame construction
- Modular frame construction allows for convenient expansion or removal of a man when needed
- Features 52" splits
- Super-Duty flat leaf springs absorb initial shock and recoils with equal force
- Round tubular steel "all surface" skids
- Optional Coaches Platform available
- Comes stock with royal blue Cone or Pro Pad
- Cone Pads available in custom colors: Black, Columbia Blue, Dark Green, Gold, Gray, Kelly Green, Maroon, Navy, Orange, Purple, Scarlet & White (please allow 4 weeks additional lead-time)

1378632	2-Man with Royal Pro Pads	\$1,799 <sup>22</sup> EA	★	S&H
1378642	2-Man with Royal Cone Pads	\$1,799 <sup>22</sup> EA	★	S&H
1378652	2-Man with Custom Cone Pads	\$1,999 <sup>22</sup> EA	★	S&H
1378633	3-Man with Royal Pro Pads	\$2,699 <sup>22</sup> EA	★	S&H
1378643	3-Man with Royal Cone Pads	\$2,699 <sup>22</sup> EA	★	S&H
1378653	3-Man with Custom Cone Pads	\$2,999 <sup>22</sup> EA	★	S&H

1378634	4-Man with Royal Pro Pads	\$3,599 <sup>22</sup> EA	★	S&H
1378644	4-Man with Royal Cone Pads	\$3,599 <sup>22</sup> EA	★	S&H
1378654	4-Man with Custom Cone Pads	\$3,999 <sup>22</sup> EA	★	S&H
1378635	5-Man with Royal Pro Pads	\$4,499 <sup>22</sup> EA	★	S&H
1378645	5-Man with Royal Cone Pads	\$4,499 <sup>22</sup> EA	★	S&H
1378655	5-Man with Custom Cone Pads	\$4,999 <sup>22</sup> EA	★	S&H
1378636	6-Man with Royal Pro Pads	\$5,299 <sup>22</sup> EA	★	S&H
1378646	6-Man with Royal Cone Pads	\$5,299 <sup>22</sup> EA	★	S&H
1378656	6-Man with Custom Cone Pads	\$5,899 <sup>22</sup> EA	★	S&H
1378637	7-Man with Royal Pro Pads	\$5,999 <sup>22</sup> EA	★	S&H
1378647	7-Man with Royal Cone Pads	\$5,999 <sup>22</sup> EA	★	S&H
1378657	7-Man with Custom Cone Pads	\$6,799 <sup>22</sup> EA	★	S&H
1362618	Optional Coaches Platform	\$199 <sup>22</sup> EA	★	S&H



### M-Series I-Man Sled

- All steel powder coated frame construction
- Super-duty flat leaf springs absorb shock and bounce back providing maximum recoil
- Tubular steel skids for durability and performance on all field types
- Stock pads available in cone or pro pad design in royal blue
- Cone pads available in custom colors: Black, Columbia Blue, Dark Green, Gold, Grey, Kelly Green, Maroon, Navy, Orange, Purple, Scarlet and White (Please allow 4 weeks additional lead-time for custom colors)

1271522	Royal Pro Pad - 230 lbs.	\$999 <sup>22</sup> EA	★	S&H
STTACKBL	Royal Cone Pad - 230 lbs.	\$999 <sup>22</sup> EA	★	S&H
STTACKLE	Custom Color Cone Pad - 230 lbs.	\$1,199 <sup>22</sup> EA	★	S&H



### Youth Blocking Sleds

- All steel powder coated "modular frame construction" allows you to add or remove a man from the sled as desired
- Super-Duty flat leaf springs absorb shock and returns it with equal force
- Powder coated tubular steel skids can be used on all field surfaces
- These sleds are ideal for the 11 to 15 year old age group
- Features 42" splits

1362612	2 Man with Royal Pro Pads - 265 lbs.	\$1,399 <sup>22</sup> EA	★	S&H
1363502	2 Man with Royal Cone Pads - 265 lbs.	\$1,399 <sup>22</sup> EA	★	S&H
1362613	3 Man with Royal Pro Pads - 405 lbs.	\$1,799 <sup>22</sup> EA	★	S&H
1363503	3 Man with Royal Cone Pads - 405 lbs.	\$1,799 <sup>22</sup> EA	★	S&H
1362615	5 Man with Royal Pro Pads - 690 lbs.	\$2,899 <sup>22</sup> EA	★	S&H
1363505	5 Man with Royal Cone Pads - 690 lbs.	\$2,899 <sup>22</sup> EA	★	S&H
1362617	7 Man with Royal Pro Pads - 970 lbs.	\$3,999 <sup>22</sup> EA	★	S&H
1363507	7 Man with Royal Cone Pads - 970 lbs.	\$3,999 <sup>22</sup> EA	★	S&H
1362618	Optional Coaches Platform	\$199 <sup>22</sup> EA	★	S&H

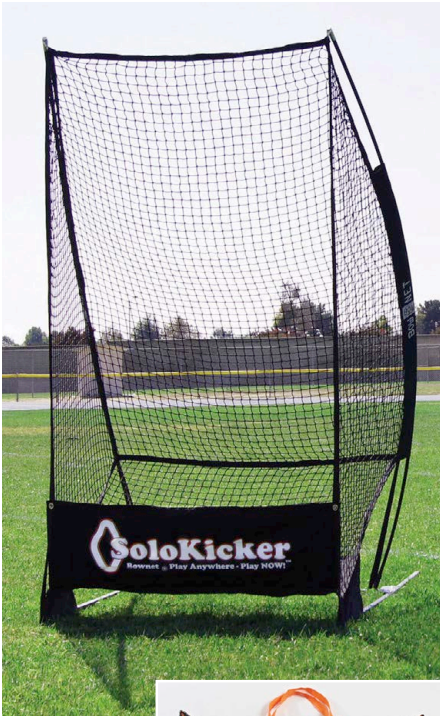

**Solo Kicker**

- Unique design makes it the most portable practice Kicker net ever
- Powder coated steel ground frame, and composite Bow Poles
- No tools needed and sets up easily in 90 seconds.
- 7'4" H x 4' W x 5'6" D - 23 lbs.
- Includes carry bag

1367618 Complete Unit \$499<sup>22</sup> EA ★



**PRO-DOWN**

**COLLEGIATE PORTABLE KICKING CAGE**

- Heavy-duty 1 5/16" galvanized steel frame
- Deep net provides less interference with kickers and helps contain balls
- Folds flat without tools or removing net
- 86" H x 48" W x 48" D - 37 lbs.
- Includes carry bag

FBPCATCH Complete Unit \$449<sup>22</sup> EA ★  
 1201733 Replacement Net Only \$134<sup>22</sup> EA ★



**PRO-DOWN**

**VARSITY KICKING CAGE**

- Heavy-duty 1 1/2" round 17-gauge galvanized steel frame
- Optic yellow sides help kickers visualize goal post
- Assembles and disassembles easily for travel and storage
- 82" H x 41" W x 41" D - 27 lbs.
- Carry bag sold separately

1052480 Complete Unit \$168<sup>22</sup> EA ★  
 1052473 Replacement Net Only \$51<sup>22</sup> EA ★  
 1363685 Carry Bag \$69<sup>22</sup> EA ★



**PASSING DRILL NET**

- Designed to aid in teaching quarterbacks the mechanics of setting up, throwing and follow through
- 3 fixed targets & 2 removable targets that can be placed in desired locations
- 1.75" mesh, 2.5 mm braided, knotless, HTPP Black netting with vinyl boarder
- Grommets provided along bottom for staking during high wind conditions
- Attaches to Football Goal Crossbar with sewn in hook & loop straps

1375096 11" H x 18' 6" W \$299<sup>22</sup> EA ★



**DEAD-ON**

**DEAD ON SPORTS TARGET**

- Ideal training for the quarterback or long snapper
- Provides a precise point of impact while blocking out visual noise
- Superior training results using Mind-Mapping which graphically represents your training to easily recall, analyze, comprehend and adjust your pass or snap.

1376899 \$399<sup>22</sup> EA ★



**PRO-DOWN**

**PASS AND SNAP TRAINER**

- Steel powder coated base and anodized aluminum upper frame
- 4' H x 4' W pocket with movable target
- Adjust pocket from 30 to 90 degrees
- 6" heavy-duty casters

FBQBTXXX 96" H x 51" W x 48" D \$699<sup>22</sup> EA ★ S&H  
 FBQBTN Replacement Net \$99<sup>22</sup> EA ★

### MULTI-PURPOSE EQUIPMENT WAGON

- All steel construction with pneumatic tires
- Use for carrying equipment, water containers, or field storage
- Front, rear, and side panels fold away for easy loading/unloading
- 1400 lb. weight capacity



**I291766**  
**I334647**

11"H (sides) x 24"W x 48"L  
Optional Hook Set

**\$309<sup>99</sup>** EA ★  
**\$17<sup>99</sup>** SET

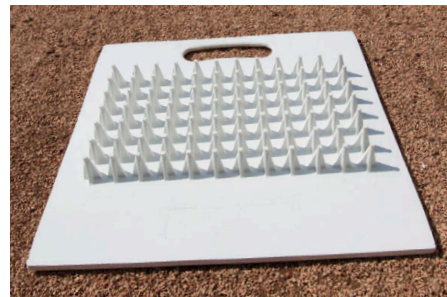

### CLEAT AND SPIKE CLEANER

- Durable molded PVC construction
- UV protected to withstand outdoor conditions
- Extended side panel
- Built in handle for easy transport

**I186796**

19" x 14"

**\$46<sup>99</sup>** EA ★



### DAY/NIGHT SIDELINE MARKERS

- Soft, crushable foam core inside durable vinyl cover
- Improved with better visibility for day or night games
- Folding design for flat storage
- Hook and loop fasteners with weighted bottom to maintain upright position
- 15"H X 15"W with 13"H numbers
- 11 piece set includes: 2-G, 2-10, 2-20, 2-30, 2-40, 1-50

**I249347**  
**I249354**  
**I269864**

11 Piece Set  
2-G, 2-20, 1-40  
2/G, 2/10, 2/20

**\$299<sup>99</sup>** SET ★  
**\$159<sup>99</sup>** SET ★  
**\$99<sup>99</sup>** SET ★



### SOLID SIDELINE MARKERS WITH HANDLE

- Vinyl covered foam with weighted bottom
- 15"H x 15"W with 10"H numbers
- 11 piece set includes: 2-G, 2-10, 2-20, 2-30, 2-40, 1-50
- 5 piece set includes: 2-G, 2-20, 1/40

**I249361**  
**I249378**

11 Piece Set  
5 Piece Set

**\$239<sup>99</sup>** SET ★  
**\$109<sup>99</sup>** SET ★



### STACKABLE SIDELINE MARKERS

- 13"H, 3 sided pyramid shaped markers
- Made of tough, flexible vinyl
- Stackable for easy storage
- 5-piece set includes: 2-G's, 2-20's, 1-40
- 11-piece set includes 2/G's, 2/10's, 2/20's, 2/30's, 2/40's, 1/50

**I245127**  
**I245134**

5 Piece Set for Flag Football  
11 Piece Set

**\$165<sup>99</sup>** SET ★  
**\$319<sup>99</sup>** SET ★



### PYLON AND SIDELINE MARKER BAGS

- Store and protect your sideline markers and pylons
- Web strap wrap around handles for easy transport
- Heavy Duty 600 Denier polyester
- Color: Black

**I370750**  
**I370751**

Sideline Marker Bag 28"H x 28"W x 14"D  
Pylon Storage Bag 18"H x 18"W x 12"D

**\$29<sup>99</sup>** EA ★  
**\$25<sup>99</sup>** EA ★



### PRO-DOWN

#### WEIGHTED ANCHORLESS PYLONS

- Stands by itself, no anchor system required
- Bright, fluorescent orange vinyl covered foam with a weighted bottom
- 18"H x 4"W x 4"D - 4 lbs. each

**MSWPYLON**

**\$41<sup>99</sup>** SET OF 4 ★



### PRO-DOWN

#### ANCHORED PYLONS

- Safe vinyl covered foam with a 'spring-back' coil anchor system
- Bright, fluorescent orange color
- Set of four includes ground anchors
- 18"H x 4"W x 4"D

**MSPYLONS**

**\$67<sup>99</sup>** SET OF 4 ★



### PRO-DOWN

#### FIRST DOWN SPOTTER

- Placed at the foot of the bullseye marker to spot the line to gain for a first down
- Weighted so it will withstand windy conditions
- Safe bonded foam covered with tear-resistant orange vinyl
- 2"H x 6"W x 35"L

**I333947**



**\$14<sup>99</sup>** EA ★

# BUY THE PACKAGE AND SAVE!

## DOWN INDICATORS AND CHAIN SETS

- Fully padded poles, indicator boxes, banners and bulls-eyes
- Down indicator is available in 7' 4" padded flip style or 7' 4" padded mechanical style with slide levers for changing down numbers
- 8'H chain sets with "Bulls-eye" design feature a two-piece pole, galvanized steel chain, swivel snap hook, molded ground stops and rubber ends.
- Fully padded banners are available in high visibility solid orange, chevron, or diagonal pattern
- J.V. chain set comes with single-ply solid orange banner



	Down Indicator Only	J.V. Chain Set & Down Indicator	Solid Chain Set & Down Indicator
<b>PRO-DOWN Flip Indicator</b>	A. <b>I370767</b> \$189 <sup>22</sup> EA ★	<b>I376988</b> \$349 <sup>22</sup> SET ★	<b>I379285</b> \$399 <sup>22</sup> SET ★
<b>DIAL-A-DOWN Pro-Style Indicator</b>	B. <b>I370757</b> \$424 <sup>22</sup> EA ★		<b>I370760</b> \$579 <sup>22</sup> SET ★
	J.V. Chain Set Only	Solid Chain Set Only	
	<b>I370765</b> \$199 <sup>22</sup> EA ★	<b>I370766</b> \$239 <sup>22</sup> SET ★	



## PRO-DOWN OFFICIALS JERSEY

- 100% polyester
- Styled with zipper and 1 1/4" black cuff on sleeve end

<b>C58</b>	M-XL	\$29 <sup>22</sup> EA ★
<b>C58XXLXX</b>	XXL	\$30 <sup>22</sup> EA ★
<b>C58XXXLG</b>	XXXL	\$31 <sup>22</sup> EA ★

## OFFICIAL'S PENALTY FLAG

- Regulation size 15" x 15" nylon with a weighted center
- Available in yellow only

**FBREFFLG** \$8<sup>22</sup> EA ★



## 10-YARD REPLACEMENT CHAIN

- Yellow powder coated steel chain
- Compatible with any chain set

**MSCHAINS** \$32<sup>22</sup> EA ★



## CHAINSMAN'S & BOXMAN'S VESTS

- Water repellent nylon construction with adjustable hook-and-loop closure
- Bright gold with black markings or bright orange with black markings
- Two vests for chain set with black diamonds
- One vest for down box with black stripes

<b>I370749</b>	Yellow/Black	\$39 <sup>22</sup> SET ★
<b>I370746</b>	Orange/Black	\$39 <sup>22</sup> SET ★

## OFFICIALS CHAIN CLIP/ YARD MARKER

- 14" Long - Orange Nylon
- Marks yardage from 0 - 50 in 5 yard increments
- End metal clip to fasten to chain

**I388017** \$7<sup>22</sup> EA



## PRO-DOWN

### PRO DOWN CHAIN SET CARRY BAG

- Will hold one complete chain set and down indicator
- Heavy-duty 600 Denier polyester construction
- Rugged nylon zipper with wrap around handles and shoulder strap
- Size: 99"L x 17.5"H x 5.25"W

**I310351** Black Only \$89<sup>22</sup> EA ★



## OFFICIALS THROW-DOWN BEAN BAG

- Weighted throw-down bean bag
- Single-sided
- Long-neck design

**I388016** White \$4<sup>22</sup> EA



### CROSS-OVER ZONE® TRACK PROTECTOR

- Made with a tough, durable polypropylene non-woven fabric
- Entire edge is vinyl wrapped with internal steel chain weighting, making it wind-proof (No stakes required)
- Easy-to-install temporary cover, resists and cushions against steel-tipped football cleats, yet allows rain to drain through
- Saves modern track materials from damaging cleats and other traffic
- Color: Black with Gold or White edging

1248326	7.5'W x 30'L	\$529 <sup>22</sup> EA	
1248333	7.5'W x 40'L	\$639 <sup>22</sup> EA	
1248340	7.5'W x 50'L	\$739 <sup>22</sup> EA	
1248296	15'W x 30'L	\$729 <sup>22</sup> EA	
1248302	15'W x 40'L	\$859 <sup>22</sup> EA	
1248319	15'W x 50'L	\$1,049 <sup>22</sup> EA	
1248357	Custom Size - 420 sqft Minimum Per Piece	\$2 <sup>22</sup> SQ.FT	

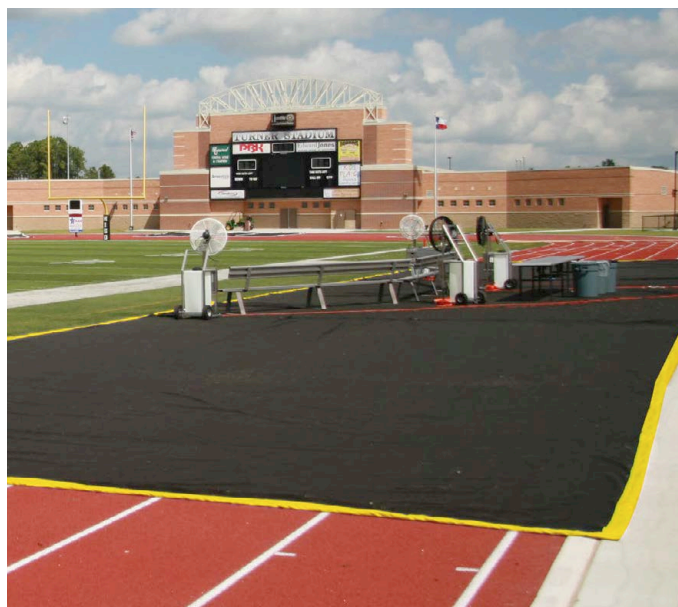

### BENCH ZONE® SIDELINE TRACK PROTECTOR

Finally, there is a way to easily cover sideline bench areas that include both turf and track surface

- Made with the toughest polypropylene geo-textile fabric
- Entire edge is vinyl wrapped with internal steel chain weighting, making it wind-proof (No stakes required)
- Designed to protect track surface in bench area where the track fits tightly around football field
- Resists and cushions against cleats and other traffic yet allows rain to drain through
- To reduce handling weight and for ease of installation, the longer pieces come in two sections that can be easily joined with Velcro® strips that are double-stitched along the entire length of each section's overlapping chain-free center edges
- 75'L comes in 1 section while 100', 125' and 150' come in 2 sections
- Color: Black with Gold or White edging

1239751	15'W x 75'L	\$1,299 <sup>22</sup> EA	
1239768	15'W x 100'L	\$1,499 <sup>22</sup> EA	
1239775	15'W x 125'L	\$1,699 <sup>22</sup> EA	
1239782	15'W x 150'L	\$1,899 <sup>22</sup> EA	
1245905	Custom Size - 801 sqft Minimum Per Piece	\$1 <sup>22</sup> SQ.FT	



### HUDDLE ZONE® SPECIAL TEAMS MAT

ELIMINATES COSTLY PENALTIES & SAVES TIMEOUTS

- Cleat-proof industrial matrix fabric with 3' squares for each player, plus front section for captain and coach
- Entire edge is vinyl wrapped with internal steel chain weighting, making it wind-proof (No stakes required)
- 3" W gold, screened-on stripes on light gray fabric, the same fabric used for Bench Zone™ turf mats
- Allows offense, defense and special teams to organize and call plays on the sideline before entering the game
- Folds easily for storage and travel to away games

1248364	9'W x 15'L - 46 lbs.	\$439 <sup>22</sup> EA
---------	----------------------	------------------------



**BENCH ZONE® SIDELINE TURF PROTECTOR**

HELPS PROTECT PLAYERS & GROUND CREW AGAINST MRSA.

- Cleats cannot penetrate, but rain, sports drinks, sweat, etc. drain through and are not absorbed and retained like in other mats. Simply hose off to clean and store.
- Fabric is super tough VIPOL® Matrix material that is non-absorbent and very durable. Air and sunlight can also penetrate so this bench tarp may be left down for longer periods without damaging turf.
- All edges are folded, internally reinforced and double-stitched.
- Grommets installed every 18".
- Packs of 6" low profile stakes sold separately.
- Available in 20 colors!
- Now used by hundreds of high schools plus dozens of NCAA and NFL teams.

**2 Year Limited Warranty**

I239669	15'W x 50'L - Specify Color	\$1,149 <sup>22</sup> EA	
I239676	15'W x 75'L - Specify Color	\$1,459 <sup>22</sup> EA	
I239683	15'W x 100'L - Specify Color	\$1,799 <sup>22</sup> EA	
I239690	15'W x 125'L - Specify Color	\$1,999 <sup>22</sup> EA	
I239706	15'W x 150'L - Specify Color	\$2,099 <sup>22</sup> EA	
I269086	Custom Size - 420 sqft Minimum (Specify Color)	\$1 <sup>22</sup> SQ.FT	

**BENCH ZONE® GET BACK LINE**

- Save your sideline from penalties

I271232	8" W - Specify Color	\$489 <sup>22</sup> EA
---------	----------------------	------------------------

**BENCH ZONE® ANCHOR STAKES**

I239713	6" - 30/Pack	\$31 <sup>22</sup> EA
I239720	6" - 115/Pack	\$75 <sup>22</sup> EA



Custom Size 30' x 150' shown

**Sideline Turf Protectors Available in:**



**CHROMA-BOND® IMPRINTING**

- Double coated multicolor imprinting that does not fade, flake or scuff like other spray on or digital imprinting
- Images are sharp, vivid and outlast any other type of imprinting
- School colors can be matched

**2 Color Logo & Lettering on a 3rd Color Background**

I297782	Overall Size up to 4'H x 50'L	\$1,749 <sup>22</sup> EA
I297799	Overall Size up to 3'H x 30'L	\$1,499 <sup>22</sup> EA

**1, 2 or 3 Color Print**

I380610	1 Color up to 25 sq. ft.	\$499 <sup>22</sup> EA
I380611	1 Color 26-50 sq. ft.	\$649 <sup>22</sup> EA
I380612	1 Color 51-100 sq. ft.	\$949 <sup>22</sup> EA
I380613	2 Color up to 25 sq. ft.	\$599 <sup>22</sup> EA
I380614	2 Color 26-50 sq. ft.	\$749 <sup>22</sup> EA
I380615	2 Color 51-100 sq. ft.	\$999 <sup>22</sup> EA
I380616	3 Color up to 25 sq. ft.	\$699 <sup>22</sup> EA
I380617	3 Color 26-51 sq. ft.	\$849 <sup>22</sup> EA
I380618	3 Color 51-100 sq. ft.	\$1,099 <sup>22</sup> EA

**1 or 2 Color Letters only**

I298154	Up to 24" Tall	\$49 <sup>22</sup> EA
I298161	Up to 36" Tall	\$59 <sup>22</sup> EA
I298178	Up to 48" Tall	\$74 <sup>22</sup> EA
I298185	Up to 60" Tall	\$86 <sup>22</sup> EA
I298192	Up to 72" Tall	\$104 <sup>22</sup> EA
I298208	Up to 84" Tall	\$119 <sup>22</sup> EA



**BENCH ZONE® PROTECTIVE TURF MAT**

- Made of tough 60mm polypropylene non-woven breathable fabric
- Color is Light Gray and comes either with or without grommets
- Grommets are spaced at 3' intervals
- Designed for plastic or rubber cleated footwear
- Stakes recommended (Sold separately - See above)

I323634	15'W x 50'L - No Grommets	\$299 <sup>22</sup> EA	
I323641	15'W x 50'L - With Grommets	\$419 <sup>22</sup> EA	
I323658	15'W x 75'L - No Grommets	\$459 <sup>22</sup> EA	
I323665	15'W x 75'L - With Grommets	\$609 <sup>22</sup> EA	
I323672	15'W x 100'L - No Grommets	\$629 <sup>22</sup> EA	
I323689	15'W x 100'L - With Grommets	\$769 <sup>22</sup> EA	
I323696	15'W x 125'L - No Grommets	\$789 <sup>22</sup> EA	
I323702	15'W x 125'L - With Grommets	\$949 <sup>22</sup> EA	
I323719	15'W x 150'L - No Grommets	\$969 <sup>22</sup> EA	
I323726	15'W x 150'L - With Grommets	\$1,119 <sup>22</sup> EA	



**HIGH SCHOOL**



**COLLEGIATE**



**ALUMINUM HIGH SCHOOL FOOTBALL GOALPOSTS**

- 6 5/8" O.D. schedule 40 aluminum gooseneck and crossbar with 4" O.D. aluminum uprights
  - Choose from either 6' 6" or 8' offset post and 20' or 30' uprights
  - All parts are powder coated
  - Ground sleeves, mounting plates and post pads sold separately
  - Specify Yellow or White powder coated finish
  - **Actual Freight charges apply to 30' Uprights**
- 2 Year Limited Warranty**

**High School Crossbar - 23' 4"**

1271072	6'6" Offset - 20' Uprights	\$8,899 <sup>22</sup> PR	
1271089	8' Offset - 20' Uprights	\$8,999 <sup>22</sup> PR	
1271096	6'6" Offset - 30' Uprights	\$9,499 <sup>22</sup> PR	
1271102	8' Offset - 30' Uprights	\$9,599 <sup>22</sup> PR	

**Collegiate Crossbar - 18' 6"**

1271119	6'6" Offset - 20' Uprights	\$8,199 <sup>22</sup> PR	
1271126	8' Offset - 20' Uprights	\$8,299 <sup>22</sup> PR	
1271133	6'6" Offset - 30' Uprights	\$8,999 <sup>22</sup> PR	
1271140	8' Offset - 30' Uprights	\$9,199 <sup>22</sup> PR	

**6 5/8" OD Post Pad**

- 6'H round post pad constructed of 4" thick foam encased in 18oz vinyl
- Specify hook and loop or zipper closure
- Color options: Black, Grey, Kelly Green, Maroon, Orange, Royal Blue, Scarlet, White, Yellow

1271218	Specify Pad Color	\$299 <sup>22</sup> EA
1271225	Specify Lettering Color	\$99 <sup>22</sup> EA

**ALUMINUM FOOTBALL GOALPOST ACCESSORIES**

**2 Year Limited Warranty**

1271157	Optional Ground Sleeve	\$479 <sup>22</sup> EA	
1271164	Access Frame	\$289 <sup>22</sup> EA	
1271171	2 Piece Wood Lid with Hole	\$119 <sup>22</sup> EA	
1271188	2 Piece Turf/Wood Lid with Hole	\$139 <sup>22</sup> EA	
1271195	Solid Wood Lid	\$64 <sup>22</sup> EA	
1271201	Solid Turf Covered Wood Lid	\$149 <sup>22</sup> EA	

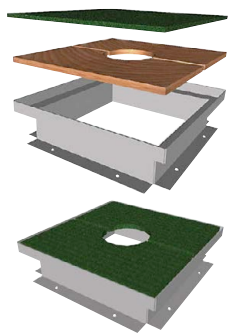

**PROTECTIVE POST PADS**

- 6'H post pad constructed of 4" thick high-density urethane foam encased in 18 oz. vinyl
- Available in two sizes with zipper or hook-and-loop closure designs
- Please specify color. Red and Blue in stock.
- Allow 4 to 6 weeks for colors other than Red or Blue
- Optional one-color or two-color lettering available at additional cost

1362696	Hook & Loop up to 4 1/2" O.D. Post	\$289 <sup>22</sup> EA
1362697	Zipper Closure up to 4 1/2" O.D. Post	\$289 <sup>22</sup> EA ★
1366530	Hook & Loop 5" - 6 1/2" O.D. Post	\$319 <sup>22</sup> EA ★
1366529	Zipper Closure 5" - 6 1/2" O.D. Post	\$319 <sup>22</sup> EA ★
1366531	Hook & Loop 5" - 6" Square Post	\$349 <sup>22</sup> EA

**OPTIONAL LETTERING FOR POST PADS**

- Add up to (8) 8" letters to your post pads
- Letters will be one-color or two-color block style
- Please allow 4 - 6 weeks production time

1362695	One-Color	\$129 <sup>22</sup> EA
1376909	Two-Color	\$219 <sup>22</sup> EA

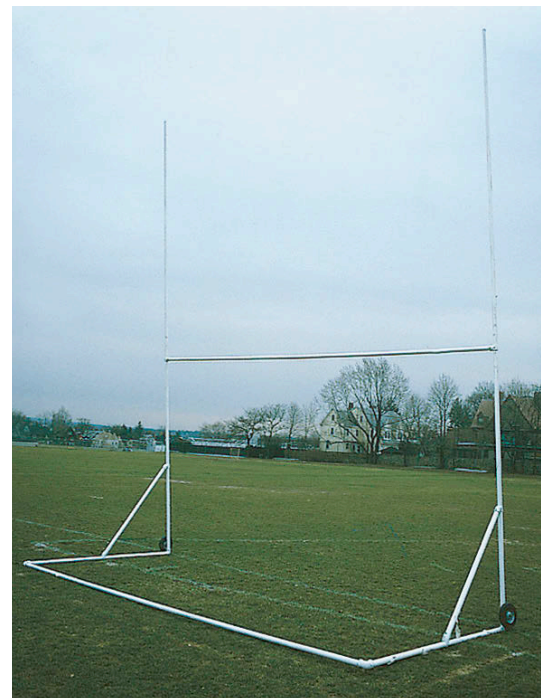

**ROLL-A-WAY FOOTBALL GOAL POSTS**

- High school size practice goal post
- Constructed of 2" O.D. galvanized steel tubing
- Easy assembly with heavy-gauge galvanized fittings
- Transport wheels included
- 24'H x 23' 4"W x 8'D

1282542	440 lbs.	\$2,999 <sup>22</sup> PR	
---------	----------	--------------------------	--



**OFFICIAL HIGH SCHOOL GOOSENECK GOALPOSTS**

- Heavy-duty 4 1/2" O.D. galvanized steel gooseneck with 5' offset
- Heavy-duty 4" O.D. galvanized steel crossbar
- High School 23' 4" Crossbar
- 2 3/8" O.D. aluminum uprights
- Includes 4 wind direction flags
- All parts are powder coated
- Optional ground sleeves recommended
- 30' uprights are UIL recommended
- **Actual Freight charges apply to 30' Uprights**



**High School Crossbar - 23' 4"**

<b>I240450</b>	White - 20' Uprights	\$3,499 <sup>22</sup>	PR ★	
<b>I240467</b>	Yellow - 20' Uprights	\$3,499 <sup>22</sup>	PR ★	
<b>I309249</b>	White - 30' Uprights	\$3,599 <sup>22</sup>	PR ★	
<b>I309256</b>	Yellow - 30' Uprights	\$3,599 <sup>22</sup>	PR ★	

**Collegiate Crossbar - 18' 6"**

<b>I240474</b>	White - 20' Uprights	\$3,499 <sup>22</sup>	PR ★	
<b>I240481</b>	Yellow - 20' Uprights	\$3,499 <sup>22</sup>	PR ★	
<b>I309263</b>	White - 30' Uprights	\$3,599 <sup>22</sup>	PR ★	
<b>I309270</b>	Yellow - 30' Uprights	\$3,599 <sup>22</sup>	PR ★	

**Goalpost Accessories**

<b>I265248</b>	Optional Ground Sleeves	\$499 <sup>22</sup>	PR ★	
<b>I197747DS</b>	Wind Direction Flags	\$15 <sup>22</sup>	4/SET ★	

**Now easier installation**  
New adjustable elbow & aluminum uprights on all models make for precise vertical alignment!



FOOTBALL



**CLASSIC "H" SHAPE STEEL GOAL POST**

- Constructed with 3.5" heavy-wall, flo-coated, galvanized steel and redesigned for easy permanent installation
- Official high school dimensions (23' 4"W x 10'H crossbar with 20'uprights)
- Includes wind direction flags and post caps to keep rain out of uprights
- Optional ground sleeves not required for installation

<b>STFBGPHS</b>	Pair of Goals	\$1,799 <sup>22</sup>	PR ★	
<b>STHSFBGP</b>	Single Goal Only	\$999 <sup>22</sup>	EA ★	
<b>STHSFBGS</b>	Optional Ground Sleeves	\$159 <sup>22</sup>	PR ★	

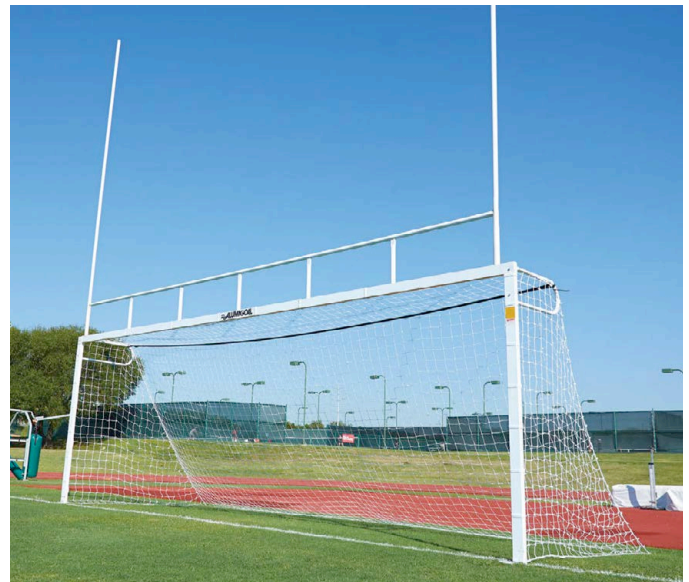

**FOOTBALL/SOCCER COMBO GOAL**

- Meets High School soccer and football regulations
- 10'H football uprights are constructed of 2" square aluminum tubing
- Width of uprights can be adjusted for H.S. (23'4") or Collegiate (18'6") play or removed for soccer play
- Soccer post are constructed of 11 gauge 2" x 4" steel tubing
- Crossbars are constructed of 14 gauge 2" x 4" steel tubing
- Two-piece engineered crossbar for increased ease of shipping and installation
- Euro style backstays are constructed of 14 gauge - 1.5" steel tubing
- Extremely corrosion resistant galvanized and white powder coated finish
- Goals include backstays, 4mm soccer nets, net fasteners and ground stakes
- Optional Ground Sleeves available for semi-permanent installation

<b>SGFBCOM</b>	I Pair of Goals - Includes Nets	\$2,899 <sup>22</sup>	PR ★	
<b>I367769</b>	4mm - Replacement Net	\$249 <sup>22</sup>	PR ★	
<b>I308082</b>	Ground Sleeves - 4/Set	\$159 <sup>22</sup>	SET ★	



dynamic  
protection  
performance  
**technology**  
**RAZOR**  
design  
evolution  
innovation  
cutting edge

BY **GEAR**  
**PRO-TEC**



**INJECTION MOLDED COMPONENTS**

All plastic components (Arches, Epaulets, Caps, Buckles) are injection molded polypropylene with impact modifiers for superior strength and structural integrity.

**SAS-TEC FOAM IMPACT ZONE PROTECTION**

SAS-TEC Visco Elastic Foam system with intelligent impact molecules is thin, lightweight and flexible with superior impact absorption properties.



**PAD-LOC BUCKLE SYSTEM**

Industry first belt attachment system, features injection molded plastic buckle/housing with automotive grade web strap and padded, protective buckle slider pad. The "tongue and groove" buckles lock into place in the recessed housing for a flush mount and no grab points.



**TACTICAL ENERGY DISPERSION SYSTEM**

Patented Z-Cool (#7,168,104) high impact perforated, inner poly arch design is sandwiched between dual layers of perforated EVA and Closed Cell Foams. This system combines for tactical impact energy dispersion and moisture management properties.

**DYNAMIC R.O.M. HINGE**



The independent exterior arches are structurally secured to the internal poly arches at 2 points, front and rear. When combined with the stretch zone fabric, the arches hinge upward, creating a full 12° more Range of Motion.

## RAZOR SKILL

- Slim profile with shorter caps for increased mobility and unrestricted arm movement for the most flexibility
- Average weight - 4.55 lbs. (size large)

1388367 Specify Size (SM - 2XL) \$349.99 EA ★



## RAZOR MULTI-POSITION

- Wider side cut, extended cap and protective deltoid pad for the most coverage and greatest protection in the RAZOR line up
- Average weight - 4.85 lbs. (size XL)

1388373 Specify Size (SM - 3XL) \$349.99 EA ★



## RAZOR OL/DL

- Extremely narrow side cut for the smallest surface area and generous neck opening for freedom of movement gives the big guys what they need for performance in the trenches
- Molded foam caps for reduced weight and snug fit
- Average weight - 4.35 lbs. (size XL)

1388380 Specify Size (MD - 3XL) \$349.99 EA ★



Size	SM	MD	LG	XL	2XL	3XL
Shoulder	16"-17"	17"-18"	18"-19"	19"-20"	20"-21"	21"-22"
Chest	36"-38"	38"-40"	40"-42"	42"-44"	44"-46"	46"-48"

## RAZOR BACK PLATE

- Features Compressed HEX Foam side panels with a SAS-TEC foam spine insert and corrugated exterior shell for maximum protection
- Universal T-nut and screw attachment fits all Razor and Z-Cool shoulder pads as well as most competitor's shoulder pads

1388433 Varsity Only \$34.99 EA ★





- SUPERIOR IMPACT ABSORPTION
- ANTI-MICROBIAL ARCH FABRIC
- COMPLETELY DRY IN 2-3 HOURS

The GEAR Pro-Tec Z-Cool® pads provide Ultra-Light Protection that's lighter than traditional pads. Our patented moisture transfer technology provides unsurpassed cooling and superior performance.



## TECHNOLOGY

### HOW Z-COOL® WORKS

#### 1. ACTIVE AIR CIRCULATION:

3-D Air Flow Brock® Foam allows air to circulate through the pad in three dimensions. As sweat coats the surface area of the waterproof foam beads, the airflow actively accelerates evaporation which is the key to body temperature cooling and post-game drying time.

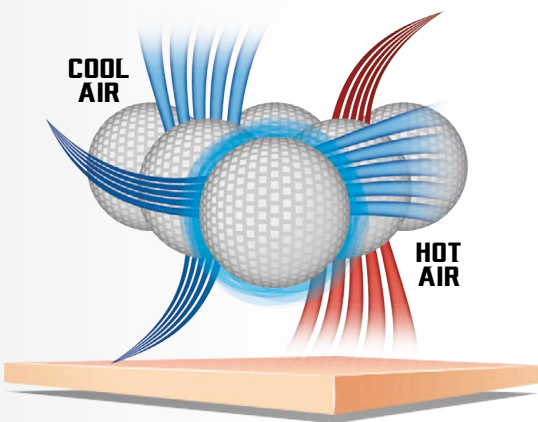

#### 2. IMPACT ENERGY DISPERSION:

Z-Cool® shoulder pads feature Brock® Foam giving them an advantage over the standard open cell foam. Upon impact, each bead in the Brock Foam padding dissipates and redistributes energy waves to the connected adjacent beads.



#### 3. ENHANCED PERFORMANCE:

The benefits of Z-Cool® technology provide athletes with an extra edge on the competition. A perfect combination of materials and engineering to cool the athlete's body by wicking away perspiration and protecting athletes with superior impact dispersion. An ultra-light design that allows athletes at all levels to perform at their very best... in the very best.

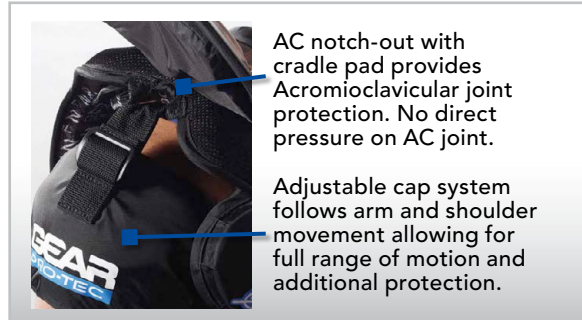

AC notch-out with cradle pad provides Acromioclavicular joint protection. No direct pressure on AC joint.

Adjustable cap system follows arm and shoulder movement allowing for full range of motion and additional protection.

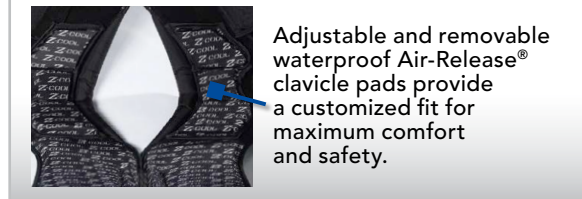

Adjustable and removable waterproof Air-Release® clavicle pads provide a customized fit for maximum comfort and safety.



**PADS FEATURE:**

- Z-Cool® Moisture Transfer System Patent #7,168,104
- Moisture Wicking Anti-Microbial Interior Fabric
- AC Notch-Out With Cradle Pad
- Adjustable Clavicle Pad System
- Adjustable Cap Pad
- Z-Cool® Plastic Inner Arch Design Patent #7,168,104
- **NEW 1.5" Belts With Non-Cut Buckles, Patent #D543,488**
- Pro-Loc Epaulet Design
- Rigid Plastic Sternum Protection

**QB/DB/WR**

- Flat pad design for low profile with all of the features needed to provide protection and improved mobility required for all skill positions
- Extended flexible arches for superior speed and mobility that are rigid and durable enough to handle the big hits
- Lightweight design with extended arch protection features fixed cap pads, making this a good choice for read option quarterbacks, wide receivers and defensive backs.

**1375236** Specify Size (XS - 2XL) \$229.99 EA ★



**QB/WR/DB PRO SELECT**

- Our lightest and most flexible pad for all skill positions
- Low profile neck design for increased range of motion
- Shorter outside poly arch plates for maximum speed and mobility
- Floating cap pads and streamlined arches offer ultimate arm mobility while still providing great protection

**1375237** Specify Size (XS - 3XL) \$229.99 EA ★



**RB/LB/DE**

- Combines all the features of a heavy hitting pad while maintaining ideal protection and performance
- This is the ideal multi-position pad
- **NEW** Extended rear arches for greater protection

**1375238** Specify Size (S - 3XL) \$229.99 EA ★



**DL/TE/DE**

- Advanced technology provides excellent impact absorption, ideal body fit and maximum freedom of movement
- This pad offers the best protection for all aspects of the game
- Wider front and back arch coverage designed for bigger players needing maximum protection on impact

**1375239** Specify Size (S - 5XL) \$229.99 EA ★

**OL/DL PRO SELECT**

- Without question the lightest weight lineman pad in the game
- Deep, open neck design offers greater range of motion and unrestricted lateral head movement.
- Super streamlined arch cut delivers unsurpassed shoulder and arm mobility

**1375240** Specify Size (M - 6XL) \$229.99 EA ★

SIZE	XSM	SM	MD	LG	XL	2XL	3XL	4XL	5XL	6XL
SHOULDER	15"-16"	16"-17"	17"-18"	18"-19"	19"-20"	20"-21"	21"-22"	22"-23"	23"-24"	24"-25"
CHEST	34"-36"	36"-38"	38"-40"	40"-42"	42"-44"	44"-46"	46"-48"	48"-50"	50"-52"	52"-54"

**GEAR**  
PRO-TEC



SIZE	SM	MD	LG	XL	2XL	3XL	4XL	5XL
SHOULDER	16"-17"	17"-18"	18"-19"	19"-20"	20"-21"	21"-22"	22"-23"	23"-24"
CHEST	36"-38"	38"-40"	40"-42"	42"-44"	44"-46"	46"-48"	48"-50"	50"-52"



### X-16F QB/WR/DB

- Lightweight flat pad design for low profile and greater mobility
- Includes built-in back plate.

1375241

Specify Size (SM - 2XL)

\$159<sup>99</sup> EA ★



### X-19F QB/DB/RB/WR

- Double arch plastic over shoulders for extra protection
- Extended arches front and back for exceptional coverage

1375242

Specify Size (MD - 2XL)

\$159<sup>99</sup> EA ★



### X-27F RB/LB/TE

- Flat pad design provides optimum combination of protection and mobility for many positions
- Short front arch for extended range of motion and extended rear arch for added protection
- The most versatile pad in the X2 Air line

1375243

Specify Size (SM - 3XL)

\$159<sup>99</sup> EA ★



### X-S0BF<sup>®</sup> OL/DL/DE/TE

- Pro-Loc Epaulets with 180 degree arms up motion and restricted down motion US Registration #2,034,235
- Double hook-up: elastic strap – top, grommeted belt – bottom

1375244

Specify Size (MD - 5XL)

\$159<sup>99</sup> EA ★



**GEAR**  
PRO-TEC

**GAMER**

- All positions - Varsity and Junior Varsity
- Moisture Management Pro-Tec Energy Foam System
- Flat pad design for low profile
- Vented arches for increased air circulation and better cooling
- Antimicrobial arch fabric reduces odor
- Built-in clavicle channels

1375245

Specify Size (SM - 2XL)

\$104<sup>99</sup> EA ★

SIZE	SM	MD	LG	XL	2XL
SHOULDER	16"-17"	17"-18"	18"-19"	19"-20"	20"-21"
CHEST	36"-38"	38"-40"	40"-42"	42"-44"	44"-46"





- Z-Cool® Moisture Transfer System Patent #7,168,104
- Moisture Wicking Anti-Microbial Interior Fabric
- AC Notch-Out With Cradle Pad
- Adjustable Clavicle Pad System
- Adjustable Cap Pad
- Z-Cool® Plastic Inner Arch Design Patent #7,168,104
- **New 1.5" Belts With Non-Cut Buckles, Patent #D543,488**
- Pro-Loc Epaulet Design
- Rigid Plastic Sternum Protection

**1375246** Specify Size (XS - 3XL) \$104.99 EA ★

SIZE	XSM	SM	MD	LG	XL	2XL	3XL
SHOULDER	12"-13"	13"-14"	14"-15"	15"-16"	16"-17"	17"-18"	18"-19"
WEIGHT	40-65 lbs.	60-80 lbs.	75-100 lbs.	95-120 lbs.	115-140 lbs.	135-160 lbs.	155-180 lbs.



## X2 AIR J.V.-F

- Low profile flat pad construction with vented arch plastic
- Perforated arch foam system allows for quick drying
- Front lock stabilizer for sternum protection
- **Now featuring 1.25" belts with non-cut buckles**

**1377129** Specify Size (XS - 3XL) \$59.99 EA ★

SIZE	XSM	SM	MD	LG	XL	2XL	3XL
SHOULDER	12"-13"	13"-14"	14"-15"	15"-16"	16"-17"	17"-18"	18"-19"
WEIGHT	30-45 lbs.	40-60 lbs.	60-80 lbs.	75-100 lbs.	95-120 lbs.	115-140 lbs.	135-160 lbs.



## AIR TECH JR.

- Flat pad design with Pro-Loc epaulets for arms up freedom US Registration #2,034,235
- Perforated moisture management foam
- Heavy-Duty mesh fabric
- Non-stretch underarm straps

**1377130** Specify Size (3XSM - XL) \$44.99 EA ★

SIZE	3XSM	2XSM	XSM	SM	MD	LG	XL
SHOULDER	9"-10"	10"-11"	11"-12"	12"-13"	13"-14"	14"-15"	15"-16"
WEIGHT	30-45 lbs.	40-65 lbs.	60-80 lbs.	75-100 lbs.	95-120 lbs.	115-140 lbs.	135-160 lbs.



## INTIMIDATOR® J.R.

- Flat pad construction
- Smooth Epaulets
- Non-stretch underarm straps

**1377131** Specify Size (3XSM - XL) \$39.99 EA ★

SIZE	3XSM	2XSM	XSM	SM	MD	LG	XL
SHOULDER	9"-10"	10"-11"	11"-12"	12"-13"	13"-14"	14"-15"	15"-16"
WEIGHT	30-45 lbs.	40-65 lbs.	60-80 lbs.	75-100 lbs.	95-120 lbs.	115-140 lbs.	135-160 lbs.



# GEAR PRO-TEC ACCESSORIES



## BACK PLATE

- Air flow foam evaporative cooling system
- Lightweight reinforced polycarbonate protective plate
- NEW screw and T-nut attachment system fits all models of GEAR Pro-Tec shoulder pads as well as most competitors (does not fit Z-Cool OL/DL Pro Select, DL/TE/DE and X2 Air X-16 pads)

<b>1317350</b>	Varsity	\$24.99 EA ★
<b>1312379</b>	Youth	\$19.99 EA ★



## EQUIPMENT BAG

- 32" x 13" x 16"
- Separate compartments for shoulder pads and helmet

<b>1312836</b>	\$30.99 EA ★
----------------	--------------

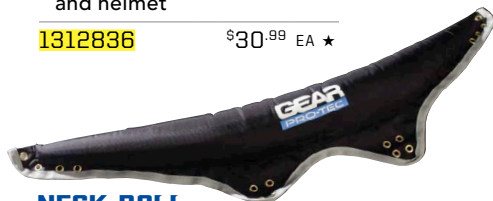

## NECK ROLL

- One size fits all
- Foam filled nylon fabric
- Attaches with screws and t-nuts

<b>1317312</b>	Varsity	\$23.99 EA ★
<b>1317329</b>	Youth	\$16.99 EA ★



## REPLACEMENT CAP PAD

- Sold in pairs, Patent #7,168,104

<b>1317374</b>	Z-COOL	\$13.99 EA ★
<b>1363686</b>	X2 AIR	\$13.99 EA ★



## WALK THRU AND INJURY VEST

- Air flow foam evaporative cooling system
- Lightweight protection

<b>1317299</b>	S (36"-38")	\$49.99 EA ★
<b>1317305</b>	M (38"-42")	\$49.99 EA ★
<b>1312621</b>	L (44"-46")	\$49.99 EA ★
<b>1312645</b>	XL (46"-48")	\$49.99 EA ★
<b>1312591</b>	2XL (48"-52")	\$49.99 EA ★
<b>1312607</b>	3XL (52"-56")	\$49.99 EA ★
<b>1312614</b>	4XL (56"+)	\$49.99 EA ★



## RIB COMBO PROTECTOR

- Air flow foam evaporative cooling system
- Lightweight reinforced polycarbonate protective plate
- Adjustable strap attachment designed to fit all models of Gear Pro-Tec shoulder pads
- Hook and loop front closure

<b>1312584</b>	S (34"-38")	\$46.99 EA ★
<b>1312577</b>	M (40"-44")	\$46.99 EA ★
<b>1312560</b>	L (46"+)	\$46.99 EA ★
<b>1317336</b>	Youth M (26"-30")	\$41.99 EA ★
<b>1317343</b>	Youth L (30"-34")	\$41.99 EA ★



## AIR-RELEASE® CLAVICLE PADS

- Waterproof layered foam pads with patented Air-Release® technology (Patent #5,701,611)
- Sold in packs of 6

<b>1312409</b>	1" Z-COOL Pattern	\$19.99 PACK ★
<b>1317490</b>	1" X2 AIR - Red Trim	\$19.99 PACK ★
<b>1312423</b>	1/2" Z-COOL JV - Black Trim	\$19.99 PACK ★



## Z-COOL® THIGH GUARDS

- Air flow and evaporative cooling system
- Sold in pairs

<b>1312706</b>	S	7" L x 5" W	\$13.99 EA ★
<b>1312690</b>	M	8" L x 6" W	\$15.99 EA ★



## KNEE PADS

**NEW!**

- Air flow and evaporative cooling system
- Sold in pairs

<b>1388428</b>	3" ROUND	\$5.99 EA ★
<b>1312522</b>	XS 4" L x 3" W	\$6.99 EA ★
<b>1312515</b>	S 5" L x 4" W	\$7.99 EA ★
<b>1312508</b>	M 5.5" L x 4.5" W	\$8.99 EA ★



## CHIN STRAP BUCKLES

**WSU**  
WHILE SUPPLIES LAST

- Impact resistant molded polycarbonate body with no rust stainless steel snap ring
- Smooth edges for no snags or cuts
- Sold in packs of 100
- Black, Cardinal Red, Dark Green, Gold, Kelly Green, Maroon, Navy, Purple, Royal, White

<b>1313451</b>	Specify Color	\$59.99 PACK
----------------	---------------	--------------



Compression garments are scientifically proven to improve performance.

# Z-COOL

# GIRDLES



### COMP PRO YOUTH 5-PAD

- 78% nylon, 22% Spandex
- Moisture wicking hip, tail and thigh pads built-in
- 1" waistband for comfortable fit
- Cup pocket standard
- Includes antimicrobial treatment

**1364282** Youth S-L \$24.99 EA ★

S-PAD YOUTH	1364283	1364284	1364285
SIZE	SM	MD	LG
WAIST	20"-22"	24"-26"	28"-30"

### COMP PRO 3-PAD

- 78% nylon, 22% Spandex
- Moisture wicking hip, and tail pads built-in
- 2" waistband for comfortable fit
- Includes antimicrobial treatment

**1364275** Adult S-3XL \$34.99 EA ★

3-PAD	1364276	1364277	1364278	1364279	1364280	1364281
SIZE	SM	MD	LG	XL	2XL	3XL
WAIST	26"-28"	30"-32"	34"-36"	38"-40"	42"-44"	44"-46"

### FLEX PRO 5-PAD

- 85% nylon, 15% elastane
- Contouring hip, tail and thigh pads built-in
- Lightweight, ventilated cup pocket and gusset
- 2" waistband for comfortable fit
- Includes antimicrobial treatment

**1378918** Adult S-3XL \$39.99 EA ★

S-PAD	1378919	1378920	1378921	1378922	1378923	1378924
SIZE	SM	MD	LG	XL	2XL	3XL
WAIST	26"-28"	30"-32"	34"-36"	38"-40"	42"-44"	44"-46"



### McDAVID 737 ADULT HEX THUDD SHORT

- Designed to adjust to your every move for continuous protection at hips, tailbone and thighs
  - Compression technology supports large muscles to help reduce pulls and fatigue
  - Includes cup pocket
- Color Options: **Black, Charcoal, Grey, White**  
 Size: **SML, MED, LRG, XLG, 2XL**

**1378139** SM-2XL \$54.99 EA



### McDAVID Pro Hex Pad 5-Pocket

- Features compression girdle with Hex Pads™ protecting hip/tail bones
  - Includes pockets for thigh pads
  - Moisture management technology that stretches and protects
  - Provides relief from chafing and skin irritation
- Color Options: **Grey, White**  
 Size: **SML, MED, LRG, XLG, 3XL**

**1416823** Adult SM-3XL \$41.99 EA



### Alleson FIVE POCKET

- 5.5oz. 85% stretch nylon/15% lycra spandex
  - Five micro-mesh pockets.
  - Entire girdle is flat-locked and cover seamed
- Color Options: **White only**  
 Size: **SML, MED, LRG, XLG, XXL**

**2001695** Adult SM-2XL(Girdle Only) \$18.99 EA



### Under Armour GAMEDAY ARMOUR IMPACT

- 84% Polyester, 16% Elastane
  - Pads are waterproof, lightweight, and ultra-durable giving you the right protection where you need it
  - 4-Way stretch fabrication allows for greater mobility in any direction
  - Moisture transport system wicks sweat away from the body
- Color Options: **040 - Graphite, Black, Hyper Green, 100 - White, Black, Black**  
 Size: **SML, MED, LG, XLG, XXL, 3XL**

UA1258457

SM-3XL

\$64.99 EA



## PRO-DOWN ULTRA-LITE PADS

### ULTRA-LITE 3-PIECE HIP PADS

• High density ultra-lite foam reinforced with plastic

<b>FBULHP3A</b>	Adult	\$11 <sup>22</sup> SET ★
<b>FBULHP3I</b>	Intermediate	\$9 <sup>22</sup> SET ★
<b>FBULHP3Y</b>	Youth	\$7 <sup>22</sup> SET ★



### ULTRA-LITE TAIL PADS

• High Density ultra-lite foam reinforced with plastic (7"L)

<b>FBTPS</b>	Slotted	\$3 <sup>22</sup> EA ★
<b>FBTPSNAP</b>	Snaps	\$4 <sup>22</sup> EA ★



### ULTRA-LITE THIGH PADS

• High density Ultra-lite foam with plastic impact plate

<b>FBULTPA</b>	9" Adult	\$11 <sup>42</sup> PR ★
<b>FBULTPI</b>	8" Intermediate	\$10 <sup>42</sup> PR ★
<b>FBULTPY</b>	7" Youth	\$9 <sup>42</sup> PR ★



### ULTRA-LITE KNEE PADS

• High density ultra-lite foam

<b>FBULKPA</b>	8.25" Adult	\$5 <sup>22</sup> PR ★
<b>FBULKPI</b>	7.5" Intermediate	\$5 <sup>42</sup> PR ★
<b>FBULKPY</b>	7" Youth	\$4 <sup>22</sup> PR ★



### YOUTH 7PC ULTRA-LITE PAD SET

• High density ultra-lite foam reinforced with plastic

<b>FBUL7YSS</b>	Sliding Snaps	\$16 <sup>22</sup> SET ★
<b>FBUL7YSLP</b>	Slotted	\$15 <sup>22</sup> SET ★



### SCHUTT DELUXE 7 PIECE PAD SET

• Lightweight foam construction  
• Equipped with floating snaps for easy fit in all brands of youth football pants

<b>1091793</b>	\$18 <sup>22</sup> SET OF 7
----------------	-----------------------------



### PRO-DOWN FLAK VEST RIB PROTECTOR

• 1" shock-absorbing foam with polyethylene coating  
• Designed to be worn under shoulder pads  
• Adjustable to fit most players

<b>P7510000</b>	Adult	\$26 <sup>22</sup> EA ★
<b>P7520000</b>	Youth	\$18 <sup>22</sup> EA ★

## PRO-DOWN VINYL DIPPED PADS

### 3 PIECE HIP PAD SET

• Vinyl dipped - slotted

<b>FBHP3SLA</b>	Adult	\$14 <sup>22</sup> SET ★
<b>FBHP3SLY</b>	Youth	\$9 <sup>22</sup> SET ★



### 3 PIECE HIP PAD SET

• Vinyl dipped plastic - reinforced snaps

<b>FBHP3SNY</b>	Youth	\$10 <sup>22</sup> SET ★
-----------------	-------	--------------------------



### THIGH PADS WITH AIR

• Vinyl dipped with plastic impact plate

<b>FBTPA</b>	9" Adult	\$9 <sup>22</sup> PR ★
<b>FBTPIA</b>	8" Intermediate	\$14 <sup>22</sup> PR ★
<b>FBTPY</b>	7" Youth	\$9 <sup>22</sup> PR ★



### THIGH PADS WITH BUMPER

• Vinyl dipped with plastic impact plate

<b>FBTPU</b>	9" Adult	\$8 <sup>42</sup> PR ★
<b>FBTPUI</b>	8" Intermediate	\$11 <sup>22</sup> PR ★



### KNEE PADS

• Vinyl dipped - air cushioned

<b>FBKP10</b>	8" Adult	\$8 <sup>22</sup> PR ★
<b>FBKP20</b>	7.5" Intermediate	\$7 <sup>22</sup> PR ★
<b>FBKP30</b>	6.75" Youth	\$6 <sup>22</sup> PR ★



### YOUTH 7 PIECE PAD SET

• Vinyl dipped foam with plastic impact plate

<b>FBVD7YFS</b>	Fixed Snaps	\$19 <sup>22</sup> SET ★
<b>FBVD7YSL</b>	Slotted	\$18 <sup>22</sup> SET ★



### SHOULDER INJURY PAD

• 1/2" Thick vinyl dipped foam  
• Lace closures front and back with underarm straps

<b>FBSIPL</b>	Large - 18"W	\$23 <sup>22</sup> EA ★
<b>FBSIPR</b>	Regular - 17"W	\$19 <sup>22</sup> EA ★
<b>FBSIPY</b>	Youth - 15"W	\$17 <sup>22</sup> EA ★



## SHOULDER PAD HARDWARE

### 1" Metal Slide

**FBMS100XPK**

 \$20<sup>99</sup> PACK OF 50

### 1" Metal T-Hook

**FBTH100XPK**

 \$25<sup>99</sup> PACK OF 50

### 1-1/2" Metal Keyway Fastener

**FBKWM150PK**

 \$29<sup>99</sup> PACK OF 50

### 1" Metal Keyway Fastener

**FBKWM100PK**

 \$24<sup>99</sup> PACK OF 50

### 1-1/2" Swivel T-Hook

**FBSTH150PK**

 \$46<sup>99</sup> PACK OF 50

### T-Hook w/BLACK ELASTIC STRAP

- 20" long heavy duty elastic strap in black
- Attached metal T-Hook
- Sold in pairs only

**1384277**

1" Hook &amp; Strap

 \$8<sup>99</sup> PR

**1384278**

1.5" Hook &amp; Strap

 \$8<sup>99</sup> PR

### 1-1/2" Metal Slide

**FBMS150XPK**

 \$25<sup>99</sup> PACK OF 50

### 1-1/2" Metal T-Hook

**FBTH150XPK**

 \$31<sup>99</sup> PACK OF 50

### SHOULDER PAD ELASTIC

- Highest quality heavy duty elastic (25 yards p/roll)

**FBRE150B**

1 1/2" Black

 \$44<sup>99</sup> ROLL

**FBRE100B**

1" Black

 \$35<sup>99</sup> ROLL

**FBRE100W**

1" White

 \$29<sup>99</sup> ROLL

### SHOULDER PAD LACES

- 40" braided round nylon that is tough and durable. Sold by the gross.

**FBSP36B**

Black

 \$31<sup>99</sup> GROSS

**FBSP36X**

White

 \$25<sup>99</sup> GROSS

## HELMET HARDWARE

### schutt

#### FOOTBALL HELMET PUMP

Engineered specifically to inflate and deflate Football helmets. Includes needle.

**1066395**

 \$17<sup>99</sup> EA

#### FOOTBALL HELMET PUMP

- Used to inflate and deflate football helmets with air bladders
- Features release valve
- Short needle included

**1384319**

 \$12<sup>99</sup> EA ★

#### FACEMASK HARDWARE

- Includes all clips, t-nuts and screws needed to attach one wire football facemask to football helmet

**1040661**

 \$6<sup>99</sup> SET

#### UNIVERSAL JAW PAD

- XS - 1/2", S - 5/8", M - 3/4", L - 7/8", XL - 1"
- Sold in packs of 24

 Size: **XSM, SML, MED, LRG, XLG.**
**FBUJPDZ**

Specify Size

 \$69<sup>99</sup> DZN

#### Metal Chinstrap Buckle

**FBMCSBXXPK**

 \$20<sup>99</sup> PACK OF 50

#### 1/8" T-Nut Short

**FBSTNXXXPK**

 \$15<sup>99</sup> PACK OF 50

#### 1/4" Chinstrap Snap

**FBCSSXXXPK**

 \$22<sup>99</sup> PACK OF 50

#### Stainless Steel Washer

**FBSSWASHPK**

 \$14<sup>99</sup> PACK OF 50

#### 1/2" T-Nut Long

**FBLTNXXXPK**

 \$15<sup>99</sup> PACK OF 50

#### 3/8" T-Nut Medium

**FBMTNXXXPK**

 \$15<sup>99</sup> PACK OF 50

#### 1/2" Helmet Screw

**FBHSXXXPK**

 \$8<sup>99</sup> PACK OF 50

#### Faceguard Loop Strap

**1405390**

 \$20<sup>99</sup> PACK OF 50

#### DNA JAW PADS

- Sold in Pairs - 1/Left & 1/Right
- Size: **5/8", 7/8", 1 1/8", 1 3/8".**

**1400530**

Specify Size

 \$10<sup>99</sup> PR

#### HELMET HARDWARE VALUE PACK

- 50 each of all helmet hardware: T-nuts, screws, snaps, buckles and washers
- Includes plastic carrying case

**1265200**

350 pieces

 \$99<sup>99</sup> EA ★

### schutt

#### SOFTSIDE SIDELINE HARDWARE KIT

- 100 S/S medium t-nuts 3/8in.
- 100 S/S short-nuts 1/8in.
- 100 S/S faceguard screws
- 100 black shoulder pad accessory screws
- 24 faceguard washers
- 12 Armourguard® Elite™ loop straps
- 12 Polyarmour loop straps
- 12 Armourguard® loop straps
- 12 plastic chin strap buckles
- 12 should pad laces
- 12 barrel lace locks
- 12 1-1/2in. Key hole slides (1" for youth kit)
- 12 1-1/2in. t-hooks (1" for youth kit)
- 4 1-1/2in. x 20 elastic shoulder pad straps (1" for youth kit)

- 1 helmet inflator pump
- 1 yard of 1in. loop tape
- 1 glycerin bottle

**1150469**

Youth

 \$249<sup>99</sup> EA

**1376903**

Varsity

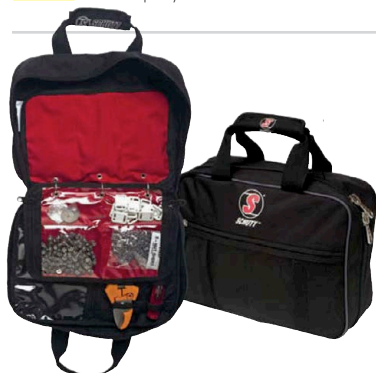
 \$259<sup>99</sup> EA



**1. 4 Stack Shoulder Pad Rack**

- Rigid base design increases strength and stability
- 4 heavy duty swivel casters for easy movement
- Holds up to 60-80 pads (Depending on pad size)

**PRO-DOWN**

**118779** 68"H x 24"W x 60"L - 52 lbs. \$319<sup>22</sup> EA ★



**2. 2 Stack Shoulder Pad Rack**

- Rigid base design increases strength and stability
- 4 heavy duty swivel casters for easy movement
- Holds up to 30 Shoulder pads (Depending on pad size)

**PRO-DOWN**

**1187748** 68"H x 24"W x 30"L - 37 lbs. \$224<sup>22</sup> EA ★



**3. Combo Helmet/Shoulder Pad Rack**

- Rigid base design increases strength and stability
- 4 heavy duty swivel casters for easy movement
- Holds up to 30 Shoulder Pads and 32 Helmets

**PRO-DOWN**

**1378672** 68"H x 24"W x 30"L - 55 lbs. \$339<sup>22</sup> EA ★

## PRO-DOWN WALL MOUNT HELMET RACK

- Chrome plated 1" steel tubing construction
- Easy to install with 4 screws (not included)
- Will hold up to 18 helmets on 3 levels
- Designed to hold football, baseball or lacrosse helmets
- Weighs 18 lbs.

**1197739** 40"H x 60"W x 15"D - 18 lbs. \$154<sup>22</sup> EA ★

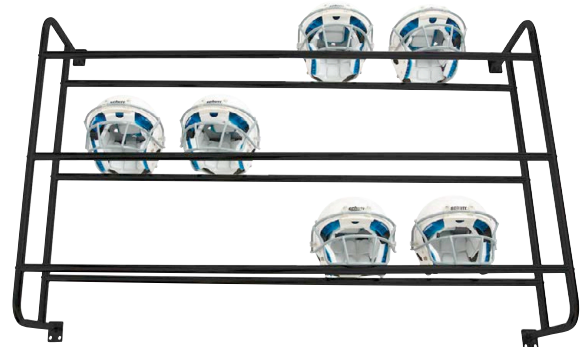

Center Stabilizing Bar

## PRO-DOWN ROLLING FOOTBALL HELMET RACK

- Black powder coated steel construction
- Base includes 4 heavy-duty rubber wheels
- Helmets are hung through the ear openings on rigid steel rods with safety curves
- Holds up to 56 helmets
- 88"H x 26"D x 26"W - 41 lbs.

**1199789** \$239<sup>22</sup> EA ★

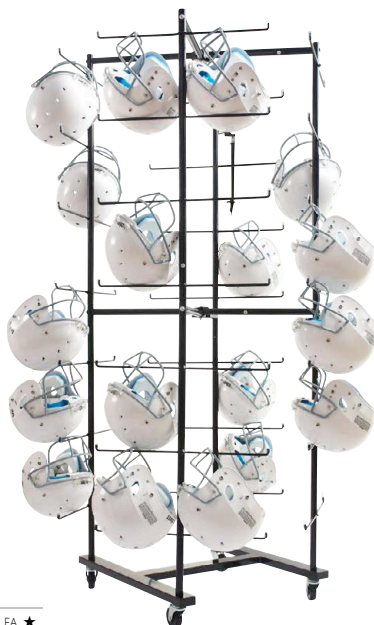

## Storage Bag



## NEW! PRO-DOWN

### FOOTBALL HELMET CART

- Constructed of 1" O.D. black powder coated steel tubing
- Heavy duty urethane swivel wheels - 2 with brakes
- 5 welded shelves make for easy assembly
- Will hold 50 football helmets with masks (can also be used for lacrosse helmets, batting helmets, etc.)
- Fits through standard doorways
- 64"H x 24"W x 61"L - 61 lbs.

**1378673**

**SNBCNET**

Storage Bag - 32" x 36" (Specify Color)

\$289<sup>22</sup> EA ★

\$10<sup>22</sup> EA ★





**MOUTHGUARD**

- Mouthguards should be used in contact and non-contact sports to reduce the risk of concussion and mouth related injuries
- Top quality Dental Vinyl for greater strength, comfort, ease of speech and breathing
- Adult size is for ages 11 and up
- 30-second custom fit
- **Youth Color Options w/Strap: Black, Gold, Scarlet, Royal**
- **Adult Color Options w/Strap: Black, Gold, Scarlet, Royal, Green, Maroon, Navy, Orange, Purple, Clear**
- **Adult Color Options Strapless: Black, Gold, Scarlet, Royal, Green, Maroon, Navy, Purple**

<b>MSMOUT</b>	Adult w/ Strap - Specify Color	\$16 <sup>22</sup> PACK OF 25
<b>I179620</b>	Youth w/Strap - Specify Color	\$16 <sup>22</sup> PACK OF 25
<b>I403270</b>	Adult Strapless - Specify Color	\$11 <sup>22</sup> EACH



**TEAM EQUIPMENT BAG**

- Heavy duty polyester equipment bag
- Rugged nylon zipper with wrap around handles
- Black only

<b>I377678</b>	33"L x 12"W x 15"H	\$19 <sup>22</sup> EA ★
----------------	--------------------	-------------------------



**MG180 MOUTHGUARD WITH STRAP**

- Provides double impression for upper and lower teeth protection
  - Features one-piece quick release helmet strap
  - \$3,200 maximum dental injury warranty
  - 35-second custom fit
- Color Options: **Black, Clear, Yellow.**

<b>I298741</b>	Adult - Specify Color	\$2 <sup>02</sup> EA
----------------	-----------------------	----------------------

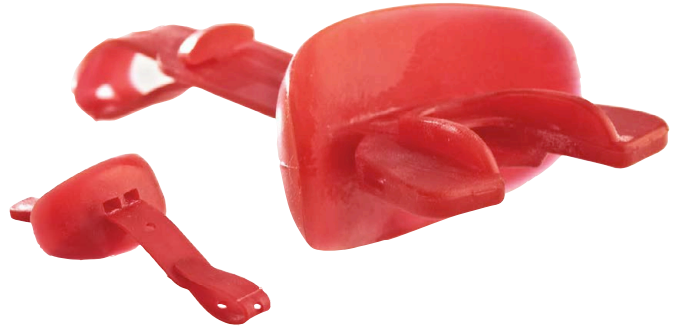

**VETTEX™ MOUTHGUARD WITH LIP PROTECTION**

- Protects lips, mouth and teeth
  - Exclusive patented breathing holes
  - Pliable thermo rubber for cushioning comfort
  - \$3,000 Dental Warranty
- Color Options: **Black, Dark Green, Gold, Navy Blue, Orange, Pink, Royal Blue, Scarlet, White.**

<b>I403320</b>	One Size Fits All - Specify Color	\$7 <sup>22</sup> EA
----------------	-----------------------------------	----------------------



**PRO ADULT MOUTHGUARD**

- Multi-layer construction with an internal shock-absorbing frame offers protection and fit that outperforms conventional mouthguards
- Shock absorbing jaw pads help protect against concussions and create a channel for improved breathing
- Shock absorbing bumper deflects impact away from front teeth
- Quick-release helmet tether
- Works with braces
- 12 per pack

<b>I361360</b>	Adult - Smoke/Black Only	\$75 <sup>22</sup> PACK
<b>I361360EA</b>	Adult - Smoke/Black Only	\$6 <sup>22</sup> EA



**GEL MAX ADULT CONVERTIBLE MOUTHGUARD**

- Gel Fit liner custom molds to teeth for tight, comfortable fit
- Exoskeletal Shock Frame
- Triple layer design with integrated breathing channel
- Convertible tether allows for use with or without a strap
- Adult Team packs of 48 sold in bulk poly bag
- Color Options: **Black, Blue/Black**

<b>I384275</b>	Specify Color - Each	\$11 <sup>22</sup> EA
<b>I379351</b>	Specify Color - 48/Pack	\$499 <sup>22</sup> PACK



### TRIPLE GAME PLAN WRIST COACH

- Allows communication of plays between players and coaches
- Specially designed with 3 game plan compartments
- Adult: 6 1/2" long band with 3" x 5" windows
- Youth: 4 1/2" long band; 2 3/4" x 3 1/2" windows
- Available in Black or White



<b>1298772</b>	Adult/Black	\$11.92 EA
<b>1298789</b>	Adult/White	\$11.92 EA
<b>1298796</b>	Youth/Black	\$11.92 EA
<b>1298802</b>	Youth/White	\$11.92 EA



### GAME DAY WRISTBAND

- Terrycloth sweatband with game plan compartment
- Weather-proofed for long use
- 3" x 5" play card window
- Color Options: **Black, White.**

**FBSWBKX** Specify Color \$9.92 EA ★



### PRO COMBAT PLAYCOACH

- Extra-large, multi-page playbook windows for game or practice
- Breathable; Dri-Fit material keeps arms cool and dry
- Integrated belt loop; designed to be worn on either the wrist or on a belt
- Contoured design for a better fit
- Flexible acetate window won't fog up
- Micro Hook & Loop technology allows for easy opening
- 6.7" x 4.7" - Adult size

<b>1388053</b>	Black	\$19.92 EA
<b>1388054</b>	White	\$19.92 EA



### THERMO HANDWARMER

- Nike Thermo-Fit technology insulating fabric keeps hands warm and comfortable on cold days
- Weather-resistant shell protects against the elements
- Secure internal pocket for mouthguard storage or heat pack
- Adjustable quick release belt fits around waist up to 44"

**1403095** Black Only \$29.92 EA



### FOOTBALL TOWEL

- Absorbent, quick drying terry cloth helps keep hands dry all game long
- Hook-and-loop closure attaches securely to QB's or center's belt
- Embroidered Swoosh design
- Locker tag logo for player ID
- Machine washable



**1403100** White Only \$15.92 EA



### SCRIMMAGE HELMET COVER

#### ONE SIZE FITS ALL

- 1/2" gripper elastic bottom to prevent slippage
- 90% Cotton/10% Lycra
- Color Options: **Black, Gold, Navy, Orange, Royal, Scarlet.**

**1071948** \$54.92 DZN



**NEW NEON COLORS!**

### LIGHTWEIGHT SCRIMMAGE VESTS

- Polyester mesh vest
- Reinforced neck and armholes
- Elastic waistband
- Color Options: **Black, Gold, Kelly, Neon Green, Neon Orange, Neon Yellow, Orange, Purple, Royal, Scarlet.**

<b>C46Y</b>	K thru 3rd Grade	\$4.92 EA ★
<b>C46</b>	4th-6th Grade, Middle School & Up	\$5.92 EA ★
<b>C47N</b>	Adult (# 1-12) GO,KE,OR,PU,RO,SC,BK only	\$7.92 DZN ★

### REVERSIBLE SCRIMMAGE VESTS

- Polyester mesh construction
- Reversible jerseys with elastic bottom
- Color Options: **Dark Green/Gold, Orange/Gold, Red/Black, Royal/Gold, Royal/Red, Silver/Black.**

<b>1262711</b>	Adult	\$77.92 DZN ★
<b>1262773</b>	Youth	\$77.92 DZN ★



### HEAVY DUTY SCRIMMAGE VEST

- Polyester Porthole mesh, elastic waist, large neck and arm holes.
- Sewn with no shoulder seams to reduce ripping and extend life.
- Color Options: **Black, Gold, Kelly, Purple, Royal, Scarlet.**

**C48** \$9.92 EA ★





**PRO-DOWN**

**WAIST LENGTH MESH JERSEY**

- Dazzle polyester double ply cowl
- Mitered, spandex/polyester, V-neck collar
- Polyester porthole mesh body with dazzle sleeves
- Cover stitched for durability
- Waist length
- Colors: Black, Dk Green, Lt Gold, Maroon, Navy, Purple, Royal, Scarlet, Vegas Gold, White

1416760 Youth S/M or L/XL \$13.22 EA  
 1416729 Adult S/M, L/XL or 2XL/3XL \$14.22 EA



**ELUSIVE JERSEY**

- 100% eXtreme mesh cationic polyester tricot mesh
- DAZZLE moisture management yoke
- Full length "Elusive Cut" jersey with lycra side inserts
- Mitered V-neck and sleeve cuffs with elastic
- Colors: Black, Black/Gold, Black/Scarlet, Black/White, Dk Green, Gold, Maroon, Navy, Navy/Gold, Navy/White, Orange, Purple, Royal, Royal/White, Scarlet, Scarlet/White, Vegas Gold, White, White/Black, White/Navy, White/Royal, White/Scarlet

1430208 Youth SM-LG \$22.22 EA  
 1430230 Adult SM-2XL \$24.22 EA



**REVERSIBLE DAZZLE FOOTBALL PANT**

- 100% stretch polyester DAZZLE cloth
- Five panel construction with modified no-fly crotch
- Sewn-in hip, knee, and tail pads made of perforated EVA for breathability and form
- Two thigh pads also made of EVA with plastic inserts for added protection
- Entire pant is washable
- Colors: Black/White, Dk Green/White, Lt Gold/Black, Maroon/White, Navy/Silver, Navy/Scarlet, Navy/White, Purple/White, Royal/Scarlet, Royal/White, Scarlet/White, Silver/Black, Vegas Gold/Black, Vegas Gold/Maroon, Vegas Gold/White



AA688DRVY Youth Pant XS-3XL \$34.22 EA

**PRO-DOWN**

**FOOTBALL PRACTICE PANT**

- 14 oz. double-knit polyester fabric
- Full duke crotch with traditional front lace closure
- 2.5" wide non-roll elastic waistband
- Elastic leg band
- Color: White

1374276 XS-6XL \$15.22 EA



BLACK



GOLD



KELLY

**FOOTBALL BELTS**

- Heavy-duty polypropylene web with heat-sealed ends.
- Nickel-plated D-rings, double riveted.
- 60" long.

Color Options: Black, Gold, Kelly, Navy, Royal, Scarlet, White.



NAVY



ROYAL



SCARLET



WHITE

FBBLTI 1" Width \$2.22 EA



**SOLO SERIES INTERGRATED DAZZLE PANT**

- 100% stretch polyester DAZZLE cloth
- Five panel construction with duke crotch
- Five sewn-in perforated EVA pads with stretch mesh pad pockets
- Attached self-material belt with chrome rings
- Entire pant is washable
- Colors: Black, Dk Green, Lt Gold, Maroon, Navy, Purple, Royal, Scarlet, Silver, Vegas Gold, White



AA688DY Youth Pant XS-3XL \$24.22 EA  
 AA688D Adult Pant SM-3XL \$31.22 EA



**SOLO SERIES INTERGRATED POLY PANT**

- 100% double-knit 13oz polyester
- Five panel construction with duke crotch
- Five sewn-in perforated EVA pads with stretch mesh pad pockets
- Attached self-material belt with chrome rings
- Entire pant is washable
- Colors: Black, Grey, Lt Gold, White



AA687PY Youth Pant SM-2XL \$20.22 EA  
 AA687P Adult Pant SM-3XL \$29.22 EA

## FLAG-A-TAG® FLAG FOOTBALL



### SONIC FLAG BELTS

- Featuring Flag-A-Tag's patented release system
- Sonic belts emit an audible "pop" to signal the play is dead
- Built for institutional use
- Flag size: 2"W x 17-1/4"L
- Sold by dozen per size/color
- Color Options: **Gold, Kelly, Royal, Scarlet, White.**

**8674223** 42" FLAG BELTS \$80<sup>99</sup> DZN ★  
**8675223** 52" FLAG BELTS \$80<sup>99</sup> DZN ★

### Socket and Plunger "POPS" when pulled from socket



**Socket Angles Belt Away From Player**

### PROGRAM KIT

- Designed to outfit two teams of twelve players
- Includes 24 belts with flags, 2 storage rings, and 1 flag football rule book
- Select either 42" or 52" belts
- Choose two colors: Gold, Kelly, Royal, Scarlet or White

**8671000** \$189<sup>99</sup> SET ★



### JUNIOR FLAG FOOTBALL PACK

**All the equipment needed for a game!**

- Package Includes:
- 24 - 42" Flag belts with flags (12 each Red and Yellow)
  - 24 - C46 Lightweight Adult mesh vests (12 each Red and Yellow)
  - 1- Junior size rubber football
  - 8 - Game cones (12")
  - 2- Official's pinnies
  - 1- Stopwatch
  - 2 - Flag belt storage rings
  - 1- USFTL rule book and official's manual
  - 1- Wheeled deluxe storage/transport bag

**1238037** 64 Pieces \$399<sup>99</sup> PACK ★



### FLAG-A-TAG® STORAGE RINGS

- Provides easy storage for all types of flag belts
- Holds 12 - 18 belts

**8671010** \$4<sup>99</sup> EA ★



### SONIC CONVERSION PACKAGE

- Converts a 2 flag belt into a triple flag belt
- Includes 12 sockets, 12 Stems and 12 flags
- Color Options: **Gold, Kelly, Royal, Scarlet, White.**

**8670023** \$35<sup>99</sup> DZN ★

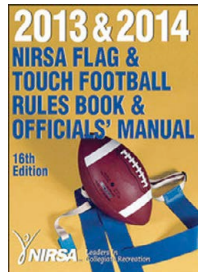

### NIRSA FLAG & TOUCH FOOTBALL RULES BOOK

- Complete rules for flag football and touch football according to the National Intramural-Recreational Sports Association

**1279283** \$17<sup>99</sup> EA

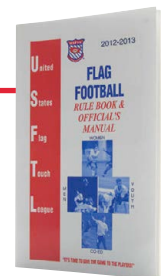

### USFTL RULE BOOK AND OFFICIALS MANUAL

- Standard rule book for all USFTL leagues
- Rule Highlights include: Definitions, Official's Manual, Games, Playing Fields, Equipment, Periods, Time factors, Overtime, Substitutions, Scoring, Conduct, Penalties, Ranking System ...and much more

**86703XXX** \$19<sup>99</sup> EA ★

**TRIPLE THREAT FLAG FOOTBALL**

**FLAG FOOTBALL BELTS**

Three flags permanently sewn onto the web belt. Entire belt comes off - no parts to lose! Belts are washable.

- Vinyl coated polyester flag will not tear
- Flag size: 2 1/4"W x 14 1/2"L
- Heavy duty polyethylene "gator clip"
- Adjusting slide for sizing
- Belt clips are color coded to indicate size
- Specify size when ordering:
- SMALL: 22" - 32" RED Belt Clip
- MEDIUM: 28" - 38" YELLOW Belt Clip
- LARGE: 32" - 44" BLUE Belt Clip
- X-LRG: 38" - 52" GREEN Belt Clip

<b>1149487</b>	Red Flags - Specify Size	\$3 <sup>99</sup> EA ★
<b>1149524</b>	Yellow Flags - Specify Size	\$3 <sup>99</sup> EA ★
<b>1149562</b>	Blue Flags - Specify Size	\$3 <sup>99</sup> EA ★
<b>1149609</b>	Green Flags - Specify Size	\$3 <sup>99</sup> EA ★

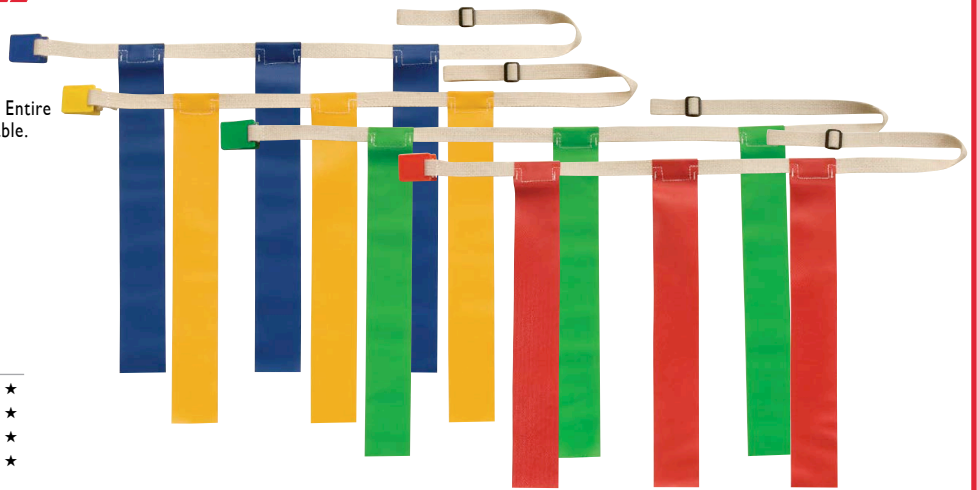

**ADJUSTABLE FLAG BELTS**

- Each belt includes 2 flags
  - Flags attached with hook-and-loop belt attachment that slide over belt
  - Flag size: 2"W x 16 1/4"L
  - Steel D-ring belt loops for sizing
  - One size fits most - belt length 42"
- Color Options: **Blue, Red, Yellow.**

<b>MSFB</b>	Belts With Flags	\$2 <sup>79</sup> EA ★
<b>MSXBELTS</b>	Belts Only	\$6 <sup>99</sup> SET OF 6 ★
<b>MSFLAGS</b>	Flags w/Belt Attachment Only	\$5 <sup>99</sup> SET OF 6 ★

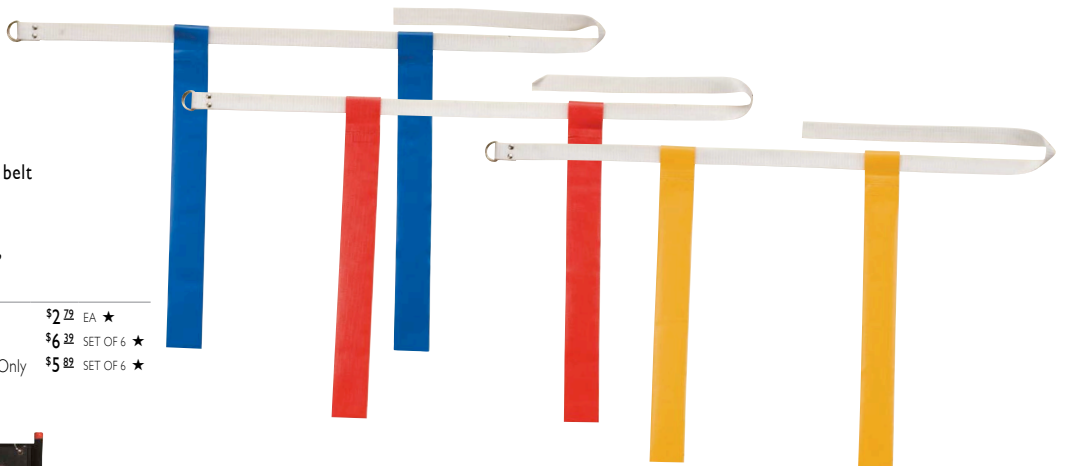

**TRIPLE THREAT DOWN BOX & SCOREBOARD**

- Combines the features of a down box and scoreboard into a single unit
- Score can be shown on both sides of the down indicator
- Made of strong light weight PVC material
- Easily disassembles for storage
- 7"H when assembled
- Includes plastic numbers, 2 dry erase score sheets with markers and pole



<b>1196160</b>	\$130 <sup>99</sup> EA ★
----------------	--------------------------



**STACKABLE SIDELINE MARKERS**

- 13"H, 3 sided pyramid shaped markers
- Made of tough, flexible vinyl
- Stackable for easy storage
- 5-piece set includes: 2-G's, 2-20's, 1-40
- 11-piece set includes 2/G's, 2/10's, 2/20's, 2/30's, 2/40's, 1/50

<b>1245127</b>	5 Piece Set for Flag Football	\$165 <sup>99</sup> SET ★
<b>1245134</b>	11 Piece Set	\$319 <sup>99</sup> SET ★



**DAY/NIGHT SIDELINE MARKERS**

- Soft, crushable foam core inside durable vinyl cover
- Folding design for flat storage
- Hook and loop fasteners with weighted bottom to maintain upright position
- 15"H X 15"W with 13"H numbers
- Includes 2-G's, 2-20's and 1-40

<b>1249354</b>	5 Piece Set for Flag Football	\$159 <sup>99</sup> SET ★
----------------	-------------------------------	---------------------------

**OFFICIAL'S PENALTY FLAG**

- Regulation size 15" x 15" nylon with a weighted center
- Available in yellow only



<b>FBREFFLG</b>	\$8 <sup>99</sup> EA ★
-----------------	------------------------

**BALL SPOTTER**

- 3 1/2" diameter pliable rubber disc



<b>1240245</b>	Orange \$9 <sup>99</sup> EA
<b>1240252</b>	Yellow \$9 <sup>99</sup> EA

**WEIGHTED ANCHORLESS PYLONS**

- Stands by itself, no anchor system required
- Bright, fluorescent orange vinyl covered foam with a weighted bottom
- 18"H x 4"W x 4"D - 4 lbs. each



<b>MSWPYLON</b>	\$41 <sup>99</sup> SET OF 4 ★
-----------------	-------------------------------



**TF-GOLD**

- Exclusive Horween S-Tack leather cover for improved grip
- Rubberized laces with Diamond-Cross weave design for better control
- Water-resistant lining for weight consistency
- 4-Ply TPU bladder for improved air retention

<b>1405135</b>	Youth, 12 - 14	\$49 <sup>99</sup> EA
----------------	----------------	-----------------------



#### PORTABLE COOLING SYSTEM

- Frame constructed of heavy wall powder coated steel
- Cools temperature in front of fan 10-20 degrees; up to 50' away
- Transports easily on two 10" "No Flat" wheels
- Includes: 50 PSI pump, 24" fan, 5 brass misting heads, 20 gallon tank (provides approximately 7 hrs. of operation)
- Dimensions: 68"H x 28"W x 31"D - 135 lbs. (empty)
- Requires 115V electrical outlet
- Warranty: Fan - 2 Years; Pump - 1 Year; Parts - 1 Year; Frame - 5 Years

SPCMIST

\$1,799<sup>22</sup> EA ★ 

### HYDRATION PACKAGES



#### GAME DAY PACKAGE

- The perfect solution for keeping athletes cool, hydrated and ready for peak performance on game day!
- Package includes: 2 Mister Portable Cooling Systems and 1 Power Tanker with Cart!

1371360

\$3,569<sup>22</sup> PACKAGE

\$5,100.00 Retail Value

**SAVE 30%**

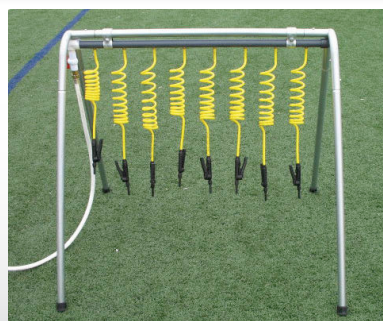

#### PRACTICE PACKAGE

- Hydrate more players faster, so more time can be spent practicing, with 20 total drinking stations!
- Package includes: 2 Powered Team Drinkers and 1 Drinking Station with 8 shut-off nozzles!

1371361

\$1,949<sup>22</sup> PACKAGE

\$2,600.00 Retail Value

**SAVE 25%**



### POWER TANKER WITH CART

- Cart constructed of heavy wall powder coated steel
- Drinking tube constructed of non-corrosive PVC
- Rides smoothly on four 10" pneumatic tires
- Includes: 8 Retractable coil drinking hoses with quick shut-off nozzles, 35 gallon tank and sanitizing tablets
- Rechargeable 12V/12amp power pack provides 8 hours of use
- Dimensions: 48"H x 29"W x 51"L - 135 lbs. (empty)

**\$1,499<sup>99</sup>**

SPCPT ★ Complete Unit



### POWERED TEAM DRINKER

- Cart constructed of heavy wall powder coated steel
- Drinking tube constructed of non-corrosive PVC
- Transports easily on two 10" "No Flat" wheels
- Includes: 6 Retractable coil drinking hoses with quick shut-off nozzles, 20 gallon tank and sanitizing tablets
- Rechargeable 12V/12amp power pack provides 8 hours of use
- Dimensions: 50"H x 21"W x 25"D - 135 lbs. (empty)

**\$1,099<sup>99</sup>**

SPCPTD ★ Complete Unit



Constructed Of Heavy Wall Powder Coated Steel

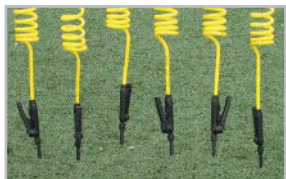

Coil Drinking Hoses With Quick Shut-Off Nozzle



10" No Flat Wheels

#### REPLACEMENT PARTS

<b>SPCCHOSE</b>	Coiled Hose and Shut Off	\$38 <sup>22</sup> EA ★
<b>SPCWAND</b>	Shut Off Assembly	\$19 <sup>22</sup> EA ★
<b>SPCBAT</b>	Replacement Battery	\$79 <sup>22</sup> EA ★
<b>ZX3930034</b>	Replacement Battery Charger	\$59 <sup>22</sup> EA ★
<b>SPCIG</b>	Sanitizing Tablets (150/Bottle)	\$8 <sup>22</sup> BOT



### PORTABLE WATER CHILLER

- Cart constructed of heavy wall powder coated steel
- Add ice to the cooler, attach water hose (not included) and the copper coil inside the tank cools drinking water as it passes through to the drinking stations
- Transports easily on two 10" "No Flat" wheels
- Includes: 6 retractable coil drinking hoses w/quick shut-off nozzles and 10 gallon cooler
- Dimensions: 50"H x 21"W x 25"D - 46 lbs.

SPCDRK2 \$649<sup>22</sup> EA ★

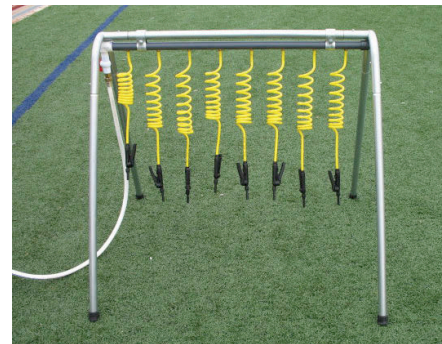

### DRINKING STATION

- Frame is made of galvanized steel tubing with removable legs for easy transport and storage
- The drinking tube is made of non-corrosive PVC
- Includes 8 drinking stations with shut-off nozzles
- Connects to a standard water hose (not included)
- Dimensions: 43"H x 53"L - 25 lbs.

SPCDS \$399<sup>22</sup> EA ★



**BOTTLE CARRIER WITH 8 QUART BOTTLES**

- PVC molded water bottle carrier with carry handle
- Holds 8 - Quart size big mouth bottles with pop-up spouts

<b>1379309</b>	Carrier & 8 Bottles	\$39 <sup>22</sup> EA ★
<b>1379308</b>	Carrier Only	\$24 <sup>22</sup> EA ★
<b>1379307</b>	Quart Size Bottle Only	\$3 <sup>22</sup> EA ★



**FOLDABLE CARRIER WITH 6 QUART BOTTLES**

- PVC molded water bottle carrier with carry handle
- Folds flat for easy storage
- Holds 6 - Quart size big mouth bottles with pop-up spouts

<b>1379325</b>	Carrier & 6 Bottles	\$36 <sup>22</sup> EA ★
<b>1379326</b>	Foldable Carrier Only	\$24 <sup>22</sup> EA ★
<b>1379307</b>	Quart Size Bottle Only	\$3 <sup>22</sup> EA ★



**Youth Kit**

- Kit consists of:
- (1) 3 Gallon Cooler
  - (1) Case of 2-1/2 Gallon Gatorade® Thirst Quencher Powder (yields 80 gallons) – Lemon Lime or Glacier Freeze
  - (24) 32 oz. Gatorade® Squeeze Bottles
  - (2) Gatorade® Squeeze Bottle Carriers

<b>1388608</b>	Lemon Lime	\$149 <sup>00</sup> EA
<b>1388609</b>	Glacier Freeze	\$149 <sup>00</sup> EA



**GATORADE® CUP CARRIER WITH LID**

- Sets nicely on the top of any standard 7 or 10 gallon cooler
- Holds 18, 8 oz. or 12 oz. paper cups
- Convenient handles allow for easy transport and serving

<b>1379353</b>	\$39 <sup>22</sup> EA
----------------	-----------------------

**NEW!**

**STRIKE ALERT HD LIGHTNING DETECTOR**

- Intuitive Graphical display
- Shows lightning strike distance up to 40 miles away
- Displays 1-hour storm trend and intensity
- Tells you how long lightning has stopped so play can resume
- Offers 360 degree storm tracking in all directions
- Audible and vibrating warnings
- Low power consumption using two AA batteries



1384282	\$239 <sup>22</sup> EA
---------	------------------------



**SKYSCAN™ TI-PLUS HEAT INDEX WARNING SYSTEM**

- Easy to read arrow display showing all ranges of dangerous heat conditions
- Audible warning sounds before heat index reaches critical levels
- Accurate display temperature, relative humidity and heat index
- Critical info is stored in memory for 24 hrs. and can be re-displayed
- Also functions as a countdown timer, stopwatch and alarm

<b>1150216</b>	\$159 <sup>22</sup> EA
----------------	------------------------



**HEAT STRESS/DEW POINT STOPWATCH**

- Accurate, responsive and simple Heat Index and Comfort Index readings
- Temperature and Humidity readings
- 1/100 second precision with 99 Lap Counter
- 30 Lap/Split Memory & 10 Hour Count Down Timer
- Calendar and Time display (12/24 hr format)
- Daily Alarm & Water Resistant up to 30 Meters
- User replaceable battery

<b>1384281</b>	\$39 <sup>22</sup> EA
----------------	-----------------------



**STRIKEALERT LIGHTNING DETECTOR**

- Early warning of lightning strikes as far as 40 miles away
- Audible alarm sounds and LED light illuminates as lightning strikes at distances of within 6 miles, 6 - 12 miles, 12 - 24 miles and 24 - 40 miles
- Indicates if lightning strikes are approaching or moving away
- Small and impact resistant, clips to your belt or bag

<b>1376905</b>	\$99 <sup>22</sup> EA
----------------	-----------------------



**SKYSCAN™ P5 LIGHTNING DETECTOR**

- Detects lightning as far as 40 miles away and accurately ranges its approach by both an audible tone and by four LED's which are ranged in miles (0-3, 3-8, 8-20, 20-40)
- Requires (2) 9V batteries (not included)
- AC adapter not included
- Rugged weather resistant case

<b>SKYSCANX</b>	Portable Unit	\$299 <sup>22</sup> EA
<b>20026501</b>	Soft Carry Case	\$39 <sup>22</sup> EA
<b>20026502</b>	110v AC Adapter	\$34 <sup>22</sup> EA

**SIGNS OF HEAT EXHAUSTION INCLUDE:  
MUSCLE CRAMPS – DIZZINESS – HEADACHE – NAUSEA**



### GATORADE® DISPENSERS/COOLERS

- Insulated to keep your favorite beverage cold
- Each has built in handles and pour spout.

1306798  
1306835

3 Gallon  
7 Gallon

\$55<sup>22</sup> EA  
\$85<sup>22</sup> EA

1306781  
1306828

10 Gallon  
60 Quart Wheeled Ice Chest

\$105<sup>22</sup> EA  
\$119<sup>22</sup> EA

### GATORADE® 7oz CUPS

- Hygienic and disposable
- 2000 cups per case
- 20 sleeves each containing 100 cups

1376906

\$109<sup>22</sup> PACK



### GATORADE® ANTIMICROBIAL TOWEL

- 100% Cotton and measures 38" inches by 24"
- Towels feature aegis antimicrobial treatment that keeps them fresh.
- Do not require bleach to stay sanitary for up to 50 washings.

1419992

38" x 24" \$14<sup>22</sup> EA



### GATORADE® DOUBLE COOLER CART

- Metal frame construction with heavy-duty transport casters
- Overall dimensions: 39"H x 18"W x 41"L
- Designed to hold one 3 gallon and one 7 or 10 gallon Gatorade cooler
- Includes cup dispenser and 2 shelves
- Coolers sold separately

1306743

61 lbs.

\$599<sup>22</sup> EA



### GATORADE® THIRST QUENCHER POWDER

- Keep hydrated with Gatorade Thirst Quencher - Scientifically formulated to help athletes perform at their best during the course of training and competition
- One case includes (40) 8.5 oz. pouches of Lemon Lime powder (Yields 1 Gallon each)
- Sold in full cases only

1306750

Lemon Lime

\$85<sup>22</sup>

EA CASE OF 40 PACKETS



### GATORADE® BOTTLES AND CARRIER

- 32 oz. wide mouth squeeze bottle
- Plastic carrier holds 6 bottles
- Sold separately

1420364

Bottles Only

\$6<sup>22</sup> EA

1420365

Carrier Only

\$28<sup>22</sup> EA



### GATORADE® PACKAGE

- Ideal for fueling athletes during games, practice or timeouts either on the field or courtside!
- Package includes: 6-32 oz. Gatorade Squeeze Bottles and Carrier, 1-case (2,000) of 7 oz. disposable cups, 1-case (40-8.5 oz.) Lemon-Lime Powder packets (Yields 40 gallons), 1 - 7 gallon Gatorade Cooler and 1 Cooler Cart!

1371311

\$479<sup>22</sup> PACK

\$600.00 Retail Value  
**SAVE 20%**

### WATER COOLER CART

- Main Frame constructed with 1" steel tubing
- Black Powder Coated Finish
- 10" Semi Pneumatic Wheels
- Holds any cooler up to 10 gallons
- Removable wire basket for cups or supplies
- Can be used indoors/ outdoors



**1373999** 22"D x 26"W x 49"H - 30 lbs **\$249.22** EA ★



### SQWINCHER SQUEEZE FREEZER POP

- Electrolyte replenishing, freezer pops are available in five assorted flavors: Lemon Lime, Orange, Cherry, Mixed Berry and Grape
- Helps reduce core body temperature and combat heat stress and fatigue
- Scientifically developed formula is designed to be absorbed by the body faster than water, helping to replenish the electrolytes and minerals needed for proper rehydration
- Each case contains 150 Freezer Pops (15 packs of 10, 2 of each flavor per pack)

**1297843** **\$54.22** CASE OF 150 POPS



### LOCKER ROOM TOWELS

- 100% cotton terry cloth

**MSTOWELS** 22"W x 44"L **\$39.22** DZN ★



### TIDI-COOLER STAND SET

- Includes: stand, trash can, 5 gallon Igloo™ cooler, and cup dispenser

<b>1263244</b>	Black Stand with Green Cooler	<b>\$239.22</b> SET ★
<b>1263251</b>	Black Stand with Yellow Cooler	<b>\$239.22</b> SET ★
<b>1255669</b>	Green Stand with Green Cooler	<b>\$239.22</b> SET ★
<b>1255676</b>	Green Stand with Yellow Cooler	<b>\$239.22</b> SET ★

### TIDI-COOLER STAND

- 100% lightweight, rust free aluminum with powder coated finish
- Wide stance base for more stability
- Includes Tidi-Court basket and security cable with keyed lock to keep lid and cooler secure to stand
- Designed for 5 gallon coolers
- Cooler sold separately

<b>1255652</b>	Green Stand & Basket	<b>\$159.22</b> EA ★
<b>1263268</b>	Black Stand & Basket	<b>\$159.22</b> EA ★



### DOUBLE COOLER™

- 5 gallon beverage container wrapped around a 2 gallon ice container
- 2 spigots to access each container if using 2 different beverages
- Lid closes to seal and separate the two containers
- Able to drain melted ice from 2 gallon container without wasting or diluting beverage in main container
- Great for powdered drinks
- Made from recyclable plastic and Eco-Friendly foam insulation
- Made in the U.S.A.

**1384379** 21.3"H x 17"W x 13"L **\$119.22** EA



### Power Breezer

#### POWER BREEZER®

- Reduce temperatures by up to 27 degrees F
- Keep players, staff, students and fans cool and comfortable
- Unique water atomization technology-No nozzles or refill pads needed
- Integrated easy-fill 100 gallon water tank
- Fan assembly stores inside of tank for easy transport and storage
- Oscillating fan assembly can cool up to 3,000 square feet of outdoor space
- Effective cooling distance up to 80 feet
- One tank of water lasts up to 50 hours of run time
- Does not get people or equipment wet
- Made in the U.S.A.

**2 Year Limited Warranty**

**1384280** 275 lbs. **\$4,999.22** EA **SeH**



### ENDURACOL™ TOWEL

- Cools instantly when wet - last up to 2 hours
- Wearable Ultra Violet Protection Factor (UPF) 45 provides sun protection when covering the skin
- Reusable and machine washable with detergent
- Color Options: **Black, Blue, Pink.**

**1366539** Specify Color **\$12.22** EA





### SPORTS BUCKET

- Made of high-density polyethylene and polypropylene
- Cool Riser Technology™ offers an elevated design for great cooling performance
- Foam-insulated body helps keep beverages cold and prevents condensation
- Triple-snap drain plug ensures easy water draining
- Side handles offer easy lifting and carrying
- 20 Quart capacity
- Available in Gray only

**I384469** 12"H x 16"W x 20"L \$35<sup>99</sup> EA



### MAXCOLD 50 ROLLER

- Cool Riser Technology™ with MaxCold insulated body and lid keep ice for 5 days at 90 degrees F\*
- Wide grip push-button and locking telescoping handle
- Integrated lid tie-down loops
- Oversized soft-ride sport wheels
- Grab-through side cooler handles
- 50 Quart (86 can) capacity
- Available in blue only

**I384465** 27.5"L x 16.75"W x 19"H \$95<sup>99</sup> EA

### SUPER TOUGH™ STX COOLER

- Bolt-through-body, comfort grip side handles with gasketed heavy-duty back-up plates
- Stainless steel latch for longer life and secure closure
- Specially anchored, heavy-duty stainless steel hinges
- UV inhibitors guard against sun damage
- 40% Heavier Body – for increased durability
- Triple-snap drain plug for quick draining and easy cleaning
- Fully foamed lid for maximum cold retention
- Holds ice up to 4 days at 90 degrees F
- Dual stainless steel lid straps for even greater lid security
- Available in White/Org Only

**I384466** 54 Qt. - 26"L x 15"W x 15.75"H \$129<sup>99</sup> EA

**I384467** 120 Qt. - 38.5"L x 17"W x 17.75"H \$215<sup>99</sup> EA



### WATER COOLER

- Rugged, durable 400 series industrial strength water coolers with Ultratherm® insulation keeps water ice cold
  - UV Protection prevents surface from chipping, peeling, or rusting
  - FDA approved white inner liner is easy to clean and resists stains
  - Lid cord attached to prevent loss
  - Optional cup dispenser holds approximately 200 (4 or 4.5 oz.) cups-not included
- 5 Year Limited Warranty**



<b>MSIGLO5X</b>	Yellow - 5 Gal.	\$69 <sup>99</sup> EA	<b>I376916</b>	Orange - 5 Gal. Seat Top	\$69 <sup>99</sup> EA
<b>MSIGLO10</b>	Yellow - 10 Gal.	\$99 <sup>99</sup> EA	<b>I384468</b>	Orange - 10 Gal. Seat Top w/Cup Dispenser	\$99 <sup>99</sup> EA
<b>I263220</b>	Green - 5 Gal.	\$69 <sup>99</sup> EA	<b>MSCUPDIS</b>	Optional Cup Dispenser	\$31 <sup>99</sup> EA
<b>I263237</b>	Green - 10 Gal.	\$105 <sup>99</sup> EA	<b>I384470</b>	4.25 oz. Cone Cup - 5000/Case	\$219 <sup>99</sup> EA

### GLIDE PRO 110 ROLLER

- Horizontal Slide-and-Lock telescoping handle provides maximum leverage and lightens lifting loads
- Cool Riser technology with Ultratherm® insulation in the body and lid keep ice for 5 days at 90 degrees F\*
- Oversized, soft-ride, sport rally wheels with UV inhibitors
- Virtually indestructible zinc-plated metal hinges
- Threaded drain plug for hose hook up and easy draining
- 110 Quart (150 can) capacity
- Available in White only



**I384464** 40"L x 19"W x 20"H \$199<sup>99</sup> EA

### 150 QUART QUICK & COOL™

- Quick-access hatch lets you access contents without letting the cold air escape
- UV inhibitors guard against sun damage
- Stain and odor-resistant liner
- Reinforced swing-up handles with tie-down
- Dual snap-fit latches secure lid
- Threaded drain plug for hose hook up
- 150 Quart (248 can) capacity
- Available in White only



**MSIGLOO150** 20"H x 18.5"W x 42"L \$199<sup>99</sup> EA



## TRAINING



### PORTABLE LACROSSE GOAL

- Full size portable lacrosse goal
- Sets up in minutes
- Includes free carry bag with wheels

1344073 7'H x 7'W x 6'D - 25 lbs. \$329<sup>22</sup> EA



### PORTABLE LACROSSE GOAL CREASE (MEN'S)

- Portable official 18' men's size lacrosse crease
- Sets up in seconds
- Includes internal weights for use on turf fields and grounds stakes for use on grass fields
- Includes free carry bag

1344080 18' Diameter - 9 lbs. \$159<sup>22</sup> EA

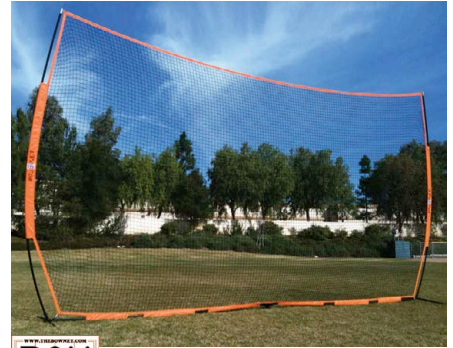

### PORTABLE BARRIER NET

- Multi-sport portable barrier net
- Sets up in minutes
- Includes free carry bag with wheels

1344097 12 1/2'H x 21 1/2'W - 56 lbs. \$499<sup>22</sup> EA

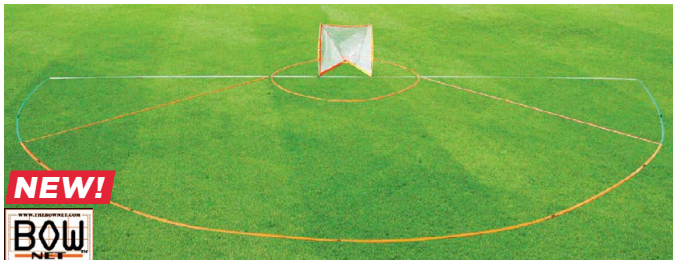

### PORTABLE LACROSSE GOAL CREASE (WOMEN'S)

- Portable official 17' womens size lacrosse crease
- Sets up in seconds
- Includes internal weights for use on turf and ground stakes for use on grass fields
- Goal and arc sold separately
- Includes free carry bag

1388427 17' Diameter - 8 lbs. \$159<sup>22</sup> EA

### WOMEN'S LACROSSE ARC

- Allows you to set up the full goal markings, indoor or outdoors
- Can be staked down on grass or weighted down for the gym floor or turf
- Weight pockets every 4 meters around perimeter act as hash marks
- Goal and crease sold separately

1388426 \$499<sup>22</sup> EA

### RAGE CAGE

### PORTABLE LACROSSE GOALS

- 6'H x 6'W x 7'D official size goal with 4mm net (Club-XT) or 3mm net (B100-XT)
- Folded size: 48"H x 47"W x 13"D
- 1.75" O.D. (Club-XT), 1.5" O.D. (B100-XT), 16 gauge orange powder-coated steel tubing
- Pre-strung net with full perimeter hem
- Carrying strap included
- Improved one-time assembly required

1369693  
1375528

Club-XT  
B100-XT

\$489<sup>22</sup> EA  
\$339<sup>22</sup> EA





**PASS BACK TARGET**

- 7'H x 4'W steel frame
- 4'H x 3'W rebound surface area
- Frame adjusts for varied rebound angles
- Add the STX Pass Master Cover and improve passing fundamentals and accuracy

1. 1377188	1) BSN Frame and Solid Target	\$249 <sup>22</sup> EA ★
2. 1371638	2) STX Pass Master Cover Only	\$49 <sup>22</sup> EA



**STX GOAL TARGETS**

- Available in two styles for two levels of challenge
- Improves shooting accuracy
- Made of durable polypropylene with reinforced edges
- Includes easy-to-attach bungee fasteners

1334555	1) Advanced	\$99 <sup>22</sup> EA
1334562	2) Junior	\$99 <sup>22</sup> EA

## GAME/PRACTICE GOALS



### PRACTICE LACROSSE GOAL

- 6'H x 6'W x 7'D deluxe practice goal
- Constructed of 13-gauge, orange powder coated, 1 1/2" O.D. steel tubing
- Lacing rods on inside front, uprights and rear ground supports
- Includes 4mm knotless nylon net, lacing cord and light weight ground anchors

**LACPRAGL**

50 lbs.

 \$199<sup>22</sup> EA ★

**NOW WITH  
6MM NET!**

### OFFICIAL LACROSSE GOAL AND NET

- 6'H x 6'W x 7'D official size NCAA® specified goal
- Constructed of 13-gauge, orange powder coated, 1.9" O.D. steel tubing and 3"W flat steel ground supports
- Lacing rods on inside front, uprights and rear ground supports
- Includes 6mm knotless nylon net, lacing cord and heavy-duty ground anchors

**LACOFFGL**

125 lbs. Per Goal

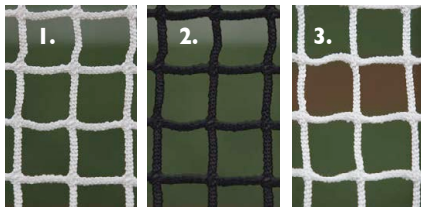
 \$799<sup>22</sup> PR ★ **S&H**

### 1. PROFESSIONAL LACROSSE NET

- White, 6mm knotless nylon lacrosse net, includes lacing cord

**1382863**

 \$169<sup>22</sup> EA ★

### 2. CHAMPIONSHIP LACROSSE NET

- Black, 5mm knotless nylon lacrosse net, includes lacing cord

**1382861**

 \$139<sup>22</sup> EA ★

### 3. PRACTICE LACROSSE NET

- White, 4mm knotless nylon lacrosse net, includes lacing cord

**1272925**

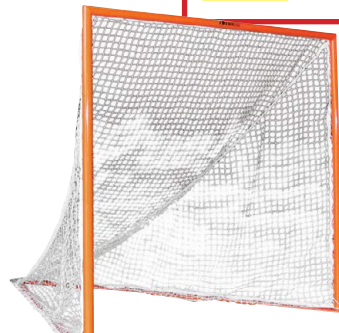
 \$109<sup>22</sup> EA ★

### OFFICIAL LACROSSE GOAL

- 6'H x 6'W x 7'D official size NCAA® specified goal
- Constructed of 11-gauge, orange powder coated, 1.9" O.D. steel tubing and 3"W flat steel ground supports
- Includes 3mm, braided knotless, 1.5" mesh, white net

**1382859**

129 lbs. Per Goal

 \$1,899<sup>22</sup> PR **S&H**

### LACROSSE BALLS

- Official NOCSAE stamped, approved game balls meet NCAA and NFHS specifications
- Available in Men's (White) and Women's (Yellow)
- Soft pink practice ball is not NOCSAE approved

**1377138**

White

 \$34<sup>22</sup> DZN

**1377140**

Yellow

 \$34<sup>22</sup> DZN

**1725UPB**

Pink Practice

 \$41<sup>22</sup> DZN

**Sport Write!**  
COACHING TOOLS

### PRO LACROSSE DRY-ERASE BOARD

- Large format enables entire team to see play
- 2 writing surfaces
- Includes premium dry erase marker
- 12 1/2"H x 16 1/2"W

**1366487**

 \$29<sup>22</sup> EA

**NEW!**

### MEN'S LACROSSE COACH'S BOARD

- Full field and half field writing surfaces front and rear
- Includes premium dry erase marker
- 8"W x 15 1/2"L

**1388111**

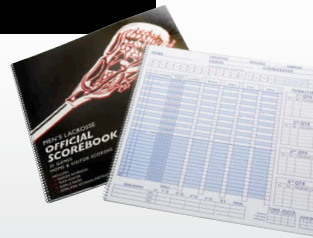
 \$12<sup>22</sup> EA ★

### MEN'S LACROSSE SCOREBOOK

- Spiral bound, 12 1/2"W x 12"H
- Comprehensive scorebook and record keeper
- Contains home and visitor scoring for 31 games

**1377127**

 \$15<sup>22</sup> EA

### BUCKET WITH LACROSSE BALLS

- Bucket with 5-dozen Maverik NOCSAE approved lacrosse balls
- Heavy-duty 6-gallon plastic bucket with cushioned lid
- Available with men's white or women's yellow balls

**1380843**

White

 \$184<sup>22</sup> EA ★

**1380845**

Yellow

 \$184<sup>22</sup> EA ★

## GAME PRACTICE GOALS



### WORLD CLASS FIELD HOCKEY GOAL

- Constructed of 2" x 2" square heavy gauge aluminum tubing
- Front goal mouth primed and painted white, 3/4" x 18"H black, painted wood bottom boards
- Official size 7'H x 12'W x 4'D
- Shipped in (6) total pieces for easy assembly
- Includes 2.5mm, 1 1/2" x 1 1/2" mesh, weather treated polyethylene net, net fasteners and transport wheels

1275049 Weight: 200 lbs. Per Goal \$2,999<sup>22</sup> PR **SAH**  
 SN383ELM Replacement Nets \$174<sup>22</sup> PR ★



### PRACTICE FIELD HOCKEY GOAL

- Constructed of 2" white powder coated, square steel tubing
- Official size 7'H x 12'W x 4'D
- Includes 3mm, 1 1/2" x 1 1/2" mesh, weather treated polyethylene net, (40) hook-and-loop net fasteners and (4) sand bags (sand not included)

1251319 Weight: 150 lbs. Per Goal \$1,249<sup>22</sup> PR ★ **SAH**  
 1125954 Optional Wheel Kit \$149<sup>22</sup> SET OF 4 ★  
 SN383ELM Replacement Nets \$174<sup>22</sup> PR ★

Optional Wheel Kit



### OFFICIAL FIELD HOCKEY GOAL

- Constructed of 2" x 3" white powder coated heavy-gauge aluminum with a mill finish
- Official size 7'H x 12'W x 4' 4 5/8" base and 3' top
- Features one-piece welded side construction with safe, smooth radius corners and Kwik Lock® Net System for net attachment
- Includes 18"H black, painted wood bottom boards, 2.5mm black net, tamper resistant net clips, 4 ground anchors and transport wheels

1382855 Weight: 185 lbs. Per Goal \$3,999<sup>22</sup> PR **SAH**  
 1382856 Replacement Net \$189<sup>22</sup> EA  
 1382857 Replacement Wheel Kit \$349<sup>22</sup> SET

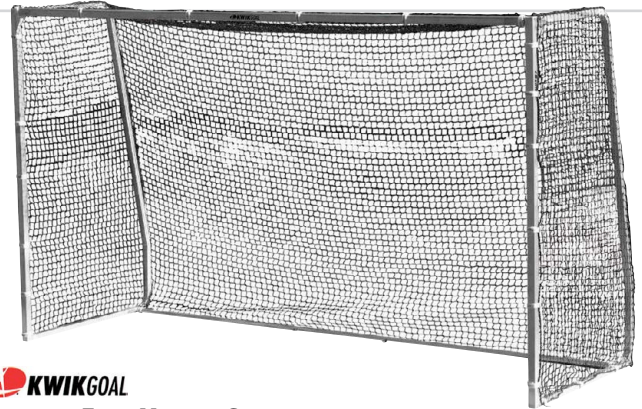

### PRACTICE FIELD HOCKEY GOAL

- Constructed of 2" x 2" square aluminum with a mill finish
- Official size 7'H x 12'W x 4' 4" base and 3' top
- Features Kwik Button® assembly
- Includes 2.5mm black net, 4 "J" anchors and Velcro net fasteners

1382858 Weight: 70 lbs. Per Goal \$2,499<sup>22</sup> PR **SAH**  
 1382856 Replacement Net \$189<sup>22</sup> EA





**PENN MONTO FIELD HOCKEY GAME BALL**

- Seamless, friction free, waterproof PVC construction
- Meets all National and International standards
- Official size

PFH116XX \$11<sup>22</sup> EA



**MacGregor PRACTICE FIELD HOCKEY BALL**

- Molded composite plastic construction for extended use
- Official size

PFH250XX \$5<sup>22</sup> EA ★



**harrow FIELD HOCKEY GAME BALL**

- Smooth, white official field hockey game ball
- Seamless, friction free, waterproof PVC construction
- NFHS approved

1382832 \$6<sup>22</sup> EA

## STICKS/PROTECTIVE

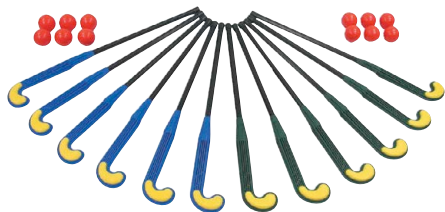

### STX MATCHPOINT

- Two piece aluminum frame and flared inside grommets for maximum durability
- Oversized 53 square inch sweet spot
- Strung weight: 120 grams
- Length: 26"

**1310122**

 \$14<sup>99</sup> EA

### PROBOT SHIN GUARDS

- The Probot shin guards offer the most protection of any Harrow shin guard
  - Features a ventilated hard plastic shell with a removable, washable liner
  - Popular among all levels of play
- Size: **SML, MED, LRG.**

**1382833**

Specify Size

 \$34<sup>99</sup> PR

### COSMIC YOUTH FIELD HOCKEY STICK

- A composite stick that has the positive characteristics of a wood stick
  - An Ideal stick for the player transitioning from wood to composite
  - Midi Head, Junior Mould
  - 25% Carbon, 75% Fiberglass, 22mm Bow, 535 grams
- Size: **32", 34", 35", 36".**

**1382834**

Specify Size

 \$45<sup>99</sup> EA

### FIELD HOCKEY GLOVE

- High density foam with a reinforced thumb hole and a ventilated palm for maximum protection without sacrificing comfort
  - Available for the left hand only
  - Available in Black only
- Size: **SML, MED, LRG.**

**1382843**

Specify Size

 \$15<sup>99</sup> EA

### DAHLIA FIELD HOCKEY STICK

- The Dahlia focuses on forgiveness with a hint of power allowing for young intermediate players an ideal tool for players improving their basics
  - Junior Mould, Ultra forgiving
  - 25% Carbon, 75% Fiberglass, 22mm Bow, 550 grams
- Size: **32", 34", 35", 36", 37".**

**1382838**

Specify Size

 \$59<sup>99</sup> EA

### HAVOC BACKPACK

- 2 Large compartments and water bottle and extra compartment on each side, plus a large bottom compartment for shoes or dirty cloths
- Cushioned back with a stick pass through pocket and reinforced strap for added strength
- 12"W x 11"D x 18"L

Color Options: **Black/Grey, Black/Lime, Black/Orange, Black/Pink, Black/Royal, Navy/Silver, Red/Silver.**

**1382848**

Specify Color

 \$79<sup>99</sup> EA

### STX ROOKIE GOGGLE

- Smaller for a better fit and increased visibility for youth players
  - Vented silicone padding for superior comfort
  - Meets ASTM standards for lacrosse and field hockey
- Color Options: **Blue/Lime, Lime/Pink, Pink.**

**1371669**

Specify Color

 \$29<sup>99</sup> EA

### CURVED SHIELD GOGGLE - CLEAR

- High impact, one piece shatter proof polycarbonate lens
- Curved shield design for maximum peripheral and down vision
- Meets ASTM standards for lacrosse and field hockey

**1363658**

 \$32<sup>99</sup> EA

**NEW!**

### POLY ARC GOGGLES

- Polycarbonate frame contours to the face for reduced weight and added strength
  - Silicone-lined, comfort grip strap for ultimate positioning on head
  - Antimicrobial, moisture wicking comfort foam
  - Meets ASTM standards for women's lacrosse
- Color Options: **Black, Green, Navy, Red, Royal, White.**

**1386383**

Specify Color

 \$49<sup>99</sup> EA



### CLASSIC ROUND POSTS

- Constructed of round tubular steel
- Powder coated finish
- Complete with brass winder and lacing bars
- Ground sleeves sold separately

#### 3" Posts - Standard Height

<b>I234404</b>	Green	\$319 <sup>22</sup> PR ★
<b>I234411</b>	Black	\$319 <sup>22</sup> PR ★

#### 2 7/8" Posts - Standard Height

<b>I234428</b>	Green	\$309 <sup>22</sup> PR ★
<b>I234435</b>	Black	\$309 <sup>22</sup> PR ★

#### GROUND SLEEVES

- Optional galvanized steel ground sleeves for Edwards Classic Round Post
- Sleeve plugs included

<b>I235708</b>	For 2 7/8" Posts	\$59 <sup>22</sup> PR ★
<b>I234473</b>	For 3" Posts	\$69 <sup>22</sup> PR ★



### WIMBLEDON SQUARE POSTS

- Constructed from 3" square "box-section" steel
- Powder coated finish
- Complete with brass winder and lacing bars
- Ground sleeves sold separately

<b>I234459</b>	Green	\$329 <sup>22</sup> PR ★
<b>I234442</b>	Black	\$329 <sup>22</sup> PR ★

#### GROUND SLEEVES

- Optional galvanized steel ground sleeves for Edwards 3" Square Posts

<b>I234480</b>		\$79 <sup>22</sup> PR ★
----------------	--	-------------------------



### BRASS WINDER UNITS

- Includes removable handle and screw

<b>1. I234527</b>	Winder Unit - Round Post	\$149 <sup>22</sup> EA ★
<b>2. I234534</b>	Winder Unit - Square Post	\$149 <sup>22</sup> EA ★
<b>I234510</b>	Handle Only	\$45 <sup>22</sup> EA ★



### EXTERNAL RATCHET POSTS - 2 7/8"

- 2 7/8" OD, powder coated steel
- Complete with ratchet, caps and pulley
- Safety ratchet has a detachable handle
- For permanent installation or semi-permanent (with optional ground sleeves)

<b>TP278GRN</b>	Standard Post - Green	\$189 <sup>22</sup> PR ★
<b>I263138</b>	Standard Post - Black	\$189 <sup>22</sup> PR ★

#### GROUND SLEEVES

- PVC ground sleeves for 2 7/8" external ratchet posts

<b>I235678</b>		\$59 <sup>22</sup> PR ★
----------------	--	-------------------------

### REPLACEMENT SAFETY RATCHET

- Heavy-duty steel safety ratchet
- Will fit most existing posts



<b>MTRT5XXX</b>	Green	\$19 <sup>22</sup> EA ★
<b>I002430</b>	Black	\$19 <sup>22</sup> EA ★

### POST CAPS

- Steel post cap and pulley
- Fits 2 7/8" post only



<b>MTCAP278</b>	Green	\$20 <sup>22</sup> EA ★
<b>I002485</b>	Black	\$20 <sup>22</sup> EA ★

### 10 & UNDER TENNIS / PICKLEBALL

- Sized right for 10 & Under Tennis and Pickleball
- Constructed of round tubular steel
- Green powder coated finish
- Complete with brass winder and lacing bars
- Ground sleeves and net sold separately



<b>I371705</b>	3" Posts - 36" Above Ground	\$289 <sup>22</sup> PR ★
<b>I296785</b>	Net for 10 & Under Courts - 42"H x 33'L	\$169 <sup>22</sup> EA ★
<b>I296778</b>	Net for 8 & Under/Pickleball Courts - 36"H x 22'L	\$129 <sup>22</sup> EA ★
<b>I234473</b>	Optional Ground Sleeve - 3" Post	\$69 <sup>22</sup> PR ★

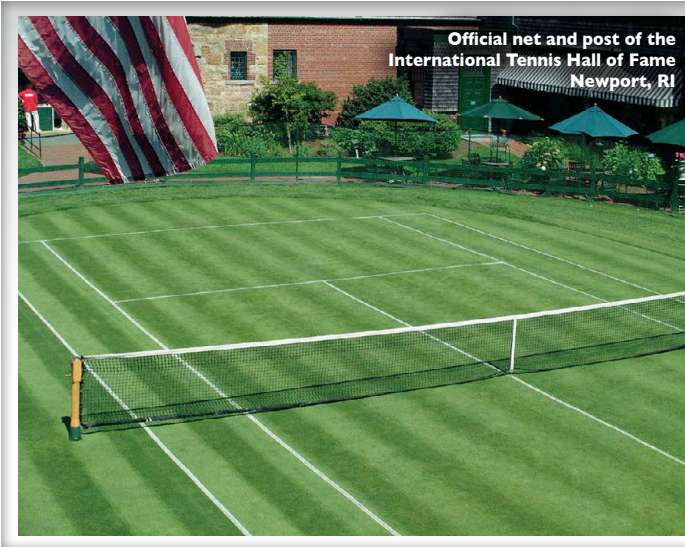

Official net and post of the International Tennis Hall of Fame Newport, RI



Throughout their 130 year history, Edwards Sports Products have been associated with tennis at the highest level, supplying Grand Slam tournaments around the world including Wimbledon & US Open. The famous 40LS net features double netting on the top six rows and a specially designed polyester headband which maximizes durability and minimizes distortion. The 30LS, 30LSDC and 40LS feature extra heavy duty 3.5mm braided polyethylene twine. These tennis nets have a quad stitched white top band & a plastic coated steel cable. The 30LS, 30LSDC & 40LS use only the finest quality materials.

**Standard net posts are spaced 42' apart. 42' nets measure 41'6" to fit between these posts. For 40' post spacing, use the 40' net which measures 39'6".**



**OUTBACK DOUBLE CENTER**

- 3.0mm high density braided polyethylene net body
- Heavy duty 18oz vinyl coated headband
- 5 rows of double center mesh
- 5/8" diameter fiberglass dowels
- Center strap and tapered center

**5 Year Limited Warranty**

**1234398** 42'L \$229<sup>22</sup> EA ★



**30LS**

- 3.5mm high density braided polyethylene net body
- Heavy duty 18 oz. vinyl coated headband
- 5/8" diameter fiberglass dowels
- Center strap and tapered center
- Edwards most popular net, and the one used at Wimbledon

**3 Year Limited Warranty**

**1162479** 42'L \$219<sup>22</sup> EA ★



**40LS DOUBLE CENTER**

- 3.5mm high density braided polyethylene net body
- Heavy duty 155mm polyester headband
- 5 rows of double center mesh
- 5/8" diameter fiberglass dowels
- Center strap and tapered center

**5 Year Limited Warranty**

**1162462** 42'L \$259<sup>22</sup> EA ★



**30LS DOUBLE CENTER**

- 3.5mm high density braided polyethylene net body
- Heavy duty 18 oz. vinyl coated headband
- 5 rows of double center mesh
- 5/8" diameter fiberglass dowels
- Center strap and tapered center

**5 Year Limited Warranty**

**1234367** 42'L \$239<sup>22</sup> EA ★



**AUSSIE**

- 3.0mm high density braided polyethylene net body
- Heavy duty 18 oz. vinyl coated headband
- 7/8" diameter fiberglass dowels
- Center strap and tapered center

**3 Year Limited Warranty**

**1234374** 42'L \$179<sup>22</sup> EA ★



**MacGregor COLLEGIATE PRO**

- 3.5mm braided HTPP net body
- Heavy duty 18 oz. vinyl coated headband
- 4 rows of lock stitching in headband
- 5/8" diameter fiberglass dowels
- Center strap and tapered center

**1296846** 42'L \$209<sup>22</sup> EA ★



**MacGregor VARSITY 300**

- 2.5mm high density braided polyethylene net body
- Heavy duty 18 oz. vinyl coated headband
- 4 rows of lock stitching in headband
- 5/8" diameter fiberglass dowel
- Center strap not included

**TN300V42Y** 42'L \$129<sup>22</sup> EA ★



**MacGregor SUPER PRO 5000**

- 3.6mm high density braided polyethylene net body
- Heavy duty 18 oz. vinyl coated headband
- 5/8" diameter fiberglass dowels
- Center strap not included

**3 Year Limited Warranty**

**TN500** Specify Length \$169<sup>22</sup> EA ★

# RolDri The Original Water Remover



**MASTER SPONGE ROLLER**

- 36" wide roller is made of tough durable polyvinyl alcohol (PVA) foam
- Designed to push water off your court surface
- Anodized aluminum handle with stainless steel, black powder coated T-socket
- Stainless steel, powder coated frame includes all stainless steel hardware
- Replacement rollers include end caps

<b>MTRDMSTR</b>	Complete Unit	\$68 <sup>22</sup> EA ★
<b>MTRRTBLU</b>	Master Replacement Roller	\$35 <sup>22</sup> EA ★



STAINLESS STEEL T-SOCKET

Rol-Dri seamless sponge roller

Rol-Dri master sponge roller



**SEAMLESS SPONGE ROLLER**

- Gray seamless sponge roller is made of soft absorbent polyurethane (PU) foam - 36" Wide
- Designed to absorb and push water from your court surface
- Anodized aluminum handle with stainless steel, black powder coated T-socket
- Stainless steel powder coated frame includes all stainless steel hardware
- Can also be used on damp grass to improve field conditions
- Replacement rollers include end caps

<b>MTRDSMLS</b>	Complete Unit	\$57 <sup>22</sup> EA ★
<b>MTRRSL36M2</b>	Seamless Replacement Roller	\$28 <sup>22</sup> EA ★

**REPLACEMENT PARTS/ACCESSORIES**

- Set includes: handle, hard poly grip, stainless steel T-bracket, hanging clip, and screws
- All hardware is stainless steel

<b>MTHDLASM</b>	Handle Assembly Set	\$26 <sup>22</sup> EA ★
-----------------	---------------------	-------------------------



**1" BALL PARK HOSES AND KITS**

- 1" I.D. heavy-duty clear hose is used by top level facilities throughout the country
- Handles 150 psi operating pressure and 600 lb. burst pressure
- Hose kit includes: hose, hose key, quick connect, spray nozzle and swivel

MSHOSE50	50' Hose Kit	\$569 <sup>22</sup> EA
MSHOSE75	75' Hose Kit	\$599 <sup>22</sup> EA
MSHOSE00	100' Hose Kit	\$689 <sup>22</sup> EA
200101075	75' Hose Only	\$229 <sup>22</sup> EA
200101100	100' Hose Only	\$279 <sup>22</sup> EA



**JET BLAST WATER BROOM**

- Constructed of heavy-duty, lightweight aluminum
- Makes cleaning dirt and debris on all types of surfaces a breeze
- Attach a standard water hose to the handle and you're ready to go
- 32" head is fitted with 8 high-pressure nozzles
- 48" head is fitted with 12 high-pressure nozzles

546032	32"	\$239 <sup>22</sup> EA
546048	48"	\$269 <sup>22</sup> EA



**5' COURTSIDE BENCH**

- Heavy duty aluminum bench with back
- 2 3/8" OD galvanized steel legs
- Planks are powder coated and come with safety end caps

**5 Year Limited Warranty**

<b>BEPG05G</b>	Forest Green	\$299 <sup>22</sup> EA ★
<b>BEPG05W</b>	White	\$299 <sup>22</sup> EA ★



## FREE-STANDING TENNIS SYSTEM

- Made of 3" powder coated square steel with stainless steel winder
- Includes three joining bars
- Transport wheels on each standard
- Net not included with system (See p. 155 for options)
- Indoor/Outdoor use

**I244205** 310 lbs. \$889<sup>22</sup> SET ★ **S&H**

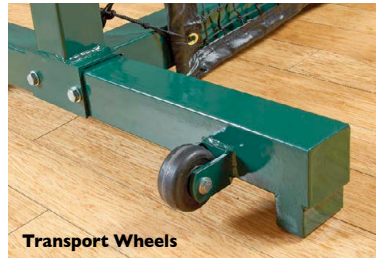

Transport Wheels



Steel Winder



## MacGregor

### ECONOMY PORTABLE TENNIS SYSTEM

- 24" steel base with rubber floor protectors and wheels for easy transport
- 2 3/8" OD galvanized steel uprights
- Standard net height and includes eye bolt at 36" to accommodate 33"H net
- Includes 40' weather treated net with rope top cable
- Indoor/Outdoor use

**TNPORTXX** 340 lbs. \$769<sup>22</sup> SET ★ **S&H**

### REPLACEMENT NETS

- 2mm polyethylene net body with 6mm rope cable
- Vinyl border top, bottom and sides

**I172492** 40'L x 42"H \$104<sup>22</sup> EA ★



### POLYESTER CENTER STRAP

- All polyester center strap
- Complete with all hardware to attach strap to net

#### 5 Year Limited Warranty

**I158267** \$9<sup>22</sup> EA ★

## MacGregor

### CENTER STRAP

- 100% nylon center strap
- 100% synthetic nylon webbing

**MTCSTRAP** \$7<sup>22</sup> EA ★

### GROUND ANCHOR

- Heavy duty zinc plated ground anchor

**I234466** \$11<sup>22</sup> EA ★

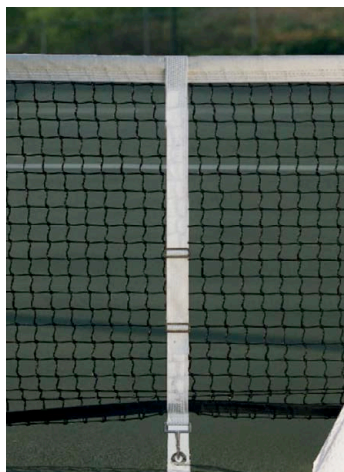

### MASTER REPLACEMENT HEADBAND

- Heavy duty vinyl headband with brass grommets every 7"
- Complete with rolled edges and double stitching
- 42'L x 6 1/2"W with 60' of lacing cord

**MTSHEADB** \$36<sup>22</sup> EA ★

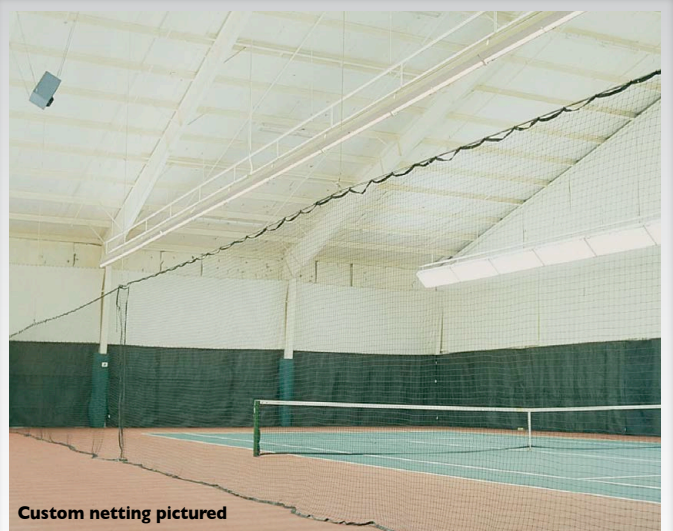

Custom netting pictured

### COURT DIVIDER NETTING

- 2.0mm x 1 3/4" mesh, EHT braided knotless netting
- 1-1/2" vinyl border double-stitched to top, bottom and sides
- Grommets every 15" along top and sides

**TNDIV420** Size: 10'H x 60'L \$299<sup>22</sup> EA ★

### CUSTOM INDOOR DIVIDER NETTING

- 2.0mm x 1 3/4" mesh, EHT braided knotless netting
- All nets include 1.5" vinyl border with grommets every 18" double sewn on top and sides
- Available in green or black
- Minimum order 200 sq. ft.

SNDIVBLK Black - Specify Size \$0<sup>62</sup> SQ.FT  
SNDIVGRN Green - Specify Size \$0<sup>62</sup> SQ.FT

### DIVIDER NETTING OPTIONS

- 18" wide green vinyl bottom plate (added to existing dimensions)

MTVBOTPL \$14<sup>22</sup> FT

### 1/4" Diameter Steel Cable

- For hanging divider netting

STCABLES Specify length of each piece \$0<sup>62</sup> FT

### Divider Hanging Kit

- 130' of steel cable, 80 snap hooks and 1 turnbuckle

STDIVKIT \$109<sup>22</sup> EA



**TUFFY® WINDSCREEN**

- The toughest, highest quality windscreen in the world
- Made with exclusive Vipol® Matrix 10 oz. material, a super-durable mesh fabric of tightly woven micro fibers
- Offers more sun UV resistance, is virtually tear proof, and has the highest puncture and tear resistance
- Allows 22% wind pass-through - 78% shade factor
- Tuffy is the only windscreen featuring LOCK-STITCH finishing to assure that it's sides and corners do not unravel
- Fully sun UV and mildew inhibitor protected
- Grommets every 12" on all 4 sides
- 9' model complete with half moon vents and a grommet strip line

**5 Year Limited Warranty**

1323566	5' High	\$0.88	SQ.FT
1285598	6' High	\$0.88	SQ.FT
1285604	9' High	\$0.22	SQ.FT
1298253	Boxed Air Vent	\$9.42	EA



**CHROMA-BOND® IMPRINTING**

- Double coated multicolor imprinting that does not fade, flake or scuff like other spray on or digital imprinting
- Images are sharp, vivid and outlast any other type of imprinting
- School colors can be matched

**2 Color Logo & Lettering on a 3rd Color Background**

1297782	Overall Size up to 4'H x 50'L	\$1,749.22	EA
1297799	Overall Size up to 3'H x 30'L	\$1,499.22	EA

**1, 2 or 3 Color Print**

1380610	1 Color up to 25 sq. ft.	\$499.22	EA
1380611	1 Color 26-50 sq. ft.	\$649.22	EA
1380612	1 Color 51-100 sq. ft.	\$949.22	EA
1380613	2 Color up to 25 sq. ft.	\$599.22	EA
1380614	2 Color 26-50 sq. ft.	\$749.22	EA
1380615	2 Color 51-100 sq. ft.	\$999.22	EA
1380616	3 Color up to 25 sq. ft.	\$699.22	EA
1380617	3 Color 26-51 sq. ft.	\$849.22	EA
1380618	3 Color 51-100 sq. ft.	\$1,099.22	EA

**1 or 2 Color Letters only**

1298154	Up to 24" T	\$49.22	EA
1298161	Up to 36" Tall	\$59.22	EA
1298178	Up to 48" Tall	\$74.22	EA
1298185	Up to 60" Tall	\$86.22	EA
1298192	Up to 72" Tall	\$104.22	EA
1298208	Up to 84" Tall	\$119.22	EA

**Fonts Available**

**ALLSTAR VARSITY** Old English

Specify colors for all imprints

Call for more font options

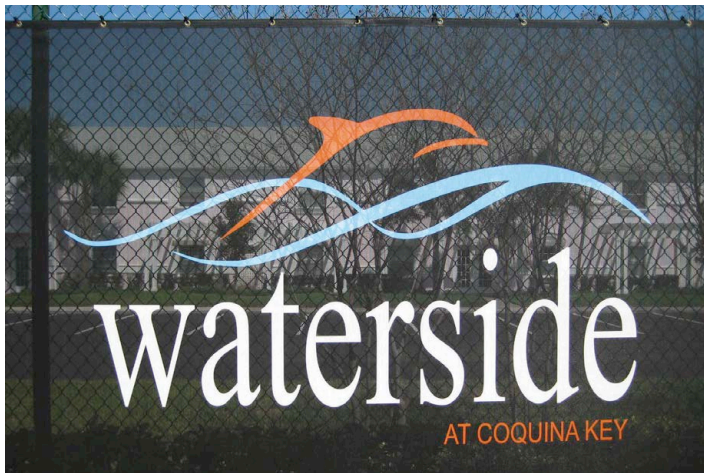

**Windscreen Measuring Tips**

It is very important to be very specific in making custom measurements. One cannot take too many notes and be too detailed when making measurements. The following tips are suggestions to help you in your measurement process.

1. For accurate measurements, make sure that the tape measure is stretched tight so that there is not any slack in the tape.
2. When possible, try to keep windscreen panels at a maximum of 60 feet in width. This allows for easier handling and installation.
3. Do NOT round off measurements. Send all measurements in feet and inches.
4. Do NOT assume two fences are the same size. Measure every fence just to be safe.
5. Make all measurements at site when possible rather than from drawings.
6. Make note of each measurement immediately. Do not make multiple measurements before writing them down.
7. Draw a rough sketch of the court to list your measurements. Match your measurements to the appropriate part of the drawing. This allows for a visual decreasing any chance of error.

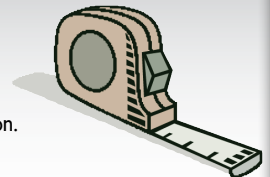



**QUALITY • DURABILITY • CRAFTSMANSHIP** For over 125 years



### POLYESTER WINDSCREEN

- Features: 8oz. polyester construction, 70% shade factor, maximum UV protection and a 6-ply 2" vinyl mesh reinforced border
  - Brass grommets on all four sides at 12" intervals
  - 9' (item 1079636) comes complete with center tie down strip and half moon vents
  - Upgrade to boxed air vents at an additional charge
- 2 Year Limited Warranty**

1158762	up tp 5'H	\$0.72	SQ.FT
1079608	6'H	\$0.73	SQ.FT
1079636	9'H	\$0.75	SQ.FT
1298253	Boxed Air Vent	\$9.42	EA

Choose from 6 color options.



### POLYPLUS WINDSCREEN (OPEN MESH)

- Perfect for high wind areas - allowing 25% wind pass through
- Constructed of open mesh Leno Polypropylene with special reinforcing threads to resist tearing
- Grommets on all 4 sides at 12" intervals
- 100% mildew proof
- 9' style includes center tie down but not air vents

MT6LPXXX	6'H - Dark Green	\$0.76	SQ.FT
MT6LPBLX	6'H - Royal Blue	\$0.76	SQ.FT
MT6LPBKX	6'H - Black	\$0.76	SQ.FT
MT9LPCXX	9'H - Dark Green or Black	\$0.82	SQ.FT



### POLYPROPYLENE WINDSCREEN (CLOSED MESH)

- Mildew and insect resistant and contains a built in UV inhibitor to withstand exposure to sun, wind and rain.
- 95% shade factor
- Includes grommets on all 4 sides spaced every 12"
- Center tie downs are included but not air vents (recommended)

MT6PPCMX	6' High - Dark Green only	\$0.83	SQ.FT
MT9PPCMX	9' High - Dark Green only	\$0.88	SQ.FT
MTCTDOWN	Center Tie Down	\$0.49	FT
1298253	Boxed Air Vent	\$9.42	EA

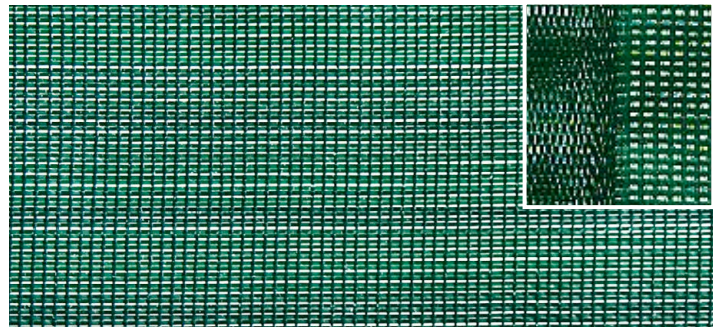

### COURTSCREEN™ THE "DO IT YOURSELF" WINDSCREEN

- At 6.2 oz. per square yard, Courtscreen™ is heavier than most traditional windscreens
- Features heavyweight polyethylene construction that resists tears while providing 20% ventilation
- Rolls are 120' long
- Don't even measure -roll it out on the ground and mount to the fence with plastic ties. Cut edges won't fray. No need for grommets. When you need air vents just cut them from the non fraying fabric where you need them.

**3 Year Limited Warranty**

<b>MTRDWS6I</b>	6'H X 120'L - Roll	\$269.22	ROLL ★
<b>MTRDWS9I</b>	9'H X 120'L - Roll	\$399.22	ROLL ★



### Windscreen Hardware and Accessories

<b>MTTWRAPS</b>	7" tie wraps (50 lbs. breaking strength)	\$16.42	PACK OF 100
<b>MTCTDOWN</b>	Center Tie Down	\$0.49	FT
<b>MTTWINEB</b>	500' Spool - 3 mm	\$39.22	EA ★

<b>MTTCTDX</b>	1/4" Black Braided Nylon-200' roll	\$27.22	ROLL
<b>MTSHOOKS</b>	2 1/2" Plated Steel S-Hooks	\$19.99	PACK OF 100



### TIDI-COOLER STAND SET

Includes: stand, trash can, 5 gallon Igloo™ cooler, and cup dispenser

<b>1263244</b>	Black Stand with Green Cooler	\$239 <sup>99</sup> SET ★
<b>1263251</b>	Black Stand with Yellow Cooler	\$239 <sup>99</sup> SET ★
<b>1255669</b>	Green Stand with Green Cooler	\$239 <sup>99</sup> SET ★
<b>1255676</b>	Green Stand with Yellow Cooler	\$239 <sup>99</sup> SET ★

### TIDI-COOLER STAND

- 100% lightweight, rust free aluminum with powder coated finish
- Wide stance base for more stability
- Includes Tidi-Court basket and security cable with keyed lock to keep lid and cooler secure to stand
- Designed for 5 gallon coolers
- Cooler sold separately

<b>1255652</b>	Green Stand & Basket	\$159 <sup>99</sup> EA ★
<b>1263268</b>	Black Stand & Basket	\$159 <sup>99</sup> EA ★



### TIDI-COURT

- Empty your pockets, store your drink cups and cans and keep trash where it belongs with the Tidi-Court
- Uses a simple hose clamp attachment to fit any shape or size post

<b>TNVALET</b>	Green	\$47 <sup>99</sup> EA ★
<b>TNVALETB</b>	Black	\$47 <sup>99</sup> EA ★

### Replacement Basket

• Handy replacement basket keeps trash where it belongs...off your court

<b>TNKPRBSK</b>	Green	\$26 <sup>99</sup> EA
<b>TNKPRBSKB</b>	Black	\$26 <sup>99</sup> EA

### Replacement Tray

• Convenient valet tray for storing valuables during play

<b>TNKPRTRY</b>	Green	\$26 <sup>99</sup> EA
<b>TNKPRTRYB</b>	Black	\$26 <sup>99</sup> EA

### Replacement Clamp

• Hose clamp attachment to fit any shape or size post

<b>TNKPRCLP</b>		\$4 <sup>99</sup> EA
-----------------	--	----------------------



### WATER COOLER

- Rugged, durable 400 series industrial strength water coolers with Ultratherm® insulation keeps water ice cold
  - UV Protection prevents surface from chipping, peeling, or rusting
  - FDA approved white inner liner is easy to clean and resists stains
  - Lid cord attached to prevent loss
  - Optional cup dispenser holds approximately 200 (4 or 4.5 oz.) cups-not included
- 5 Year Limited Warranty**



<b>MSIGLO5X</b>	Yellow - 5 Gal.	\$69 <sup>99</sup> EA
<b>MSIGLO10</b>	Yellow - 10 Gal.	\$99 <sup>99</sup> EA
<b>1263220</b>	Green - 5 Gal.	\$69 <sup>99</sup> EA
<b>1263237</b>	Green - 10 Gal.	\$105 <sup>99</sup> EA
<b>1376916</b>	Orange - 5 Gal. Seat Top	\$69 <sup>99</sup> EA
<b>1384468</b>	Orange - 10 Gal. Seat Top w/Cup Dispenser	\$99 <sup>99</sup> EA
<b>MSCUPDIS</b>	Optional Cup Dispenser	\$31 <sup>99</sup> EA
<b>1384470</b>	4.25 oz. Cone Cup - 5000/Case	\$219 <sup>99</sup> EA



### SCOREKEEPER

- Chrome steel unit with swivel base
- Game numbers are 4" x 7" plastic
- Includes 2 sets of game numbers (0 to 9), 2 sets of "sets won" (0 to 5), name plate and pen
- Hose clamp attachment

<b>MTKEEPER</b>		\$45 <sup>99</sup> EA ★
<b>MTSKNUMB</b>	Replacement Numbers	\$29 <sup>99</sup> SET ★

### TENNIS SCORE TUBE™

- Use tennis balls to keep score
  - PVC tube with holes to indicate set score
  - A stainless steel hose clamp is supplied to secure to post or net
  - Hooks are supplied for fence mounting
- Color Options: **Black, Blue, Green, White.**

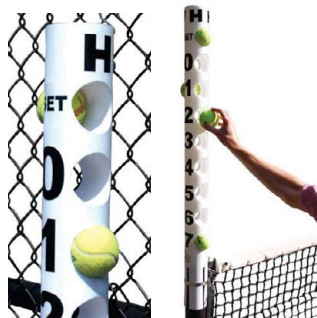

1296099	Specify Color	\$35 <sup>99</sup> EA
---------	---------------	-----------------------

### QUICKSCORE

- Portable scorecard that sits on top of the net.
- Includes both game & set scores.
- Contains game numbers up to 7 to allow scoring for regular as well as pro sets



<b>1274219</b>	Set of 4	\$165 <sup>99</sup> SET
----------------	----------	-------------------------

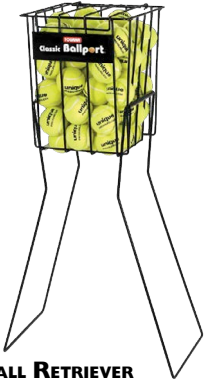

### 70 BALL RETRIEVER

- Heavy duty wire construction
- Handles flip over to create stand for ball dispensing
- 32"H - 6 lbs.

MTINSTRU \$39<sup>99</sup> EA



### 85 BALL RETRIEVER

- Heavy duty wire construction
- 32"H - 5 lbs.

MTRETRIE \$39<sup>99</sup> EA

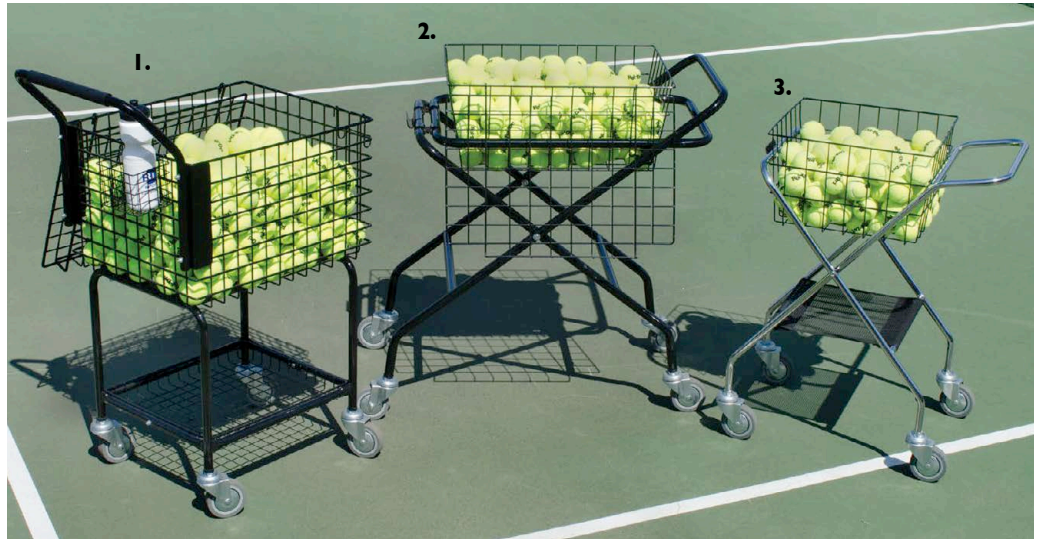

### 1. DELUXE TEACHING CART

- Powder coated steel frame, vinyl coated basket with foam grip
- Rubber 4" wheels with sealed ball bearings
- Locking lid that lays flat against the side
- Includes basket hanger and convenient water bottle holder
- Holds 325 tennis balls
- Basket Height - 42 1/2"H
- Top Basket - 19" W x 23"L

1342550 \$259<sup>99</sup> EA ★

### 2. FOLDABLE TEACHING CART

- Powder coated steel frame, vinyl coated basket with foam grip
- Folds easily for storage and transportation
- 4" rubber wheels with sealed ball bearings
- Lockable lid
- Includes basket hanger
- Holds 250 tennis balls
- Basket Height - 38"H
- Basket size - 20"W x 30"L

1342543 \$209<sup>99</sup> EA ★

### 3. MINI TEACHING CART

- Chrome steel construction with removable basket
- Folds easily for storage and transportation
- 4" smooth rolling rubber wheels
- Includes mesh bottom storage tray and convenient basket hanger on front of cart
- Hold 150 tennis balls
- Basket height - 34"H
- Basket size - 18"W x 25"L

1369476 \$135<sup>99</sup> EA ★



## TENNIS BALL MACHINE ACCESSORIES

### ELITE FREEDOM

- The battery operated Freedom offers 2-4 hours of court time
- The Freedom's over sized wheels and extended handle provide unequalled portability
- Enjoy playing against such advanced features such as full corner-to-corner random oscillation, up to 50 degree lobs and speeds of up to 70 miles per hour
- 150 ball capacity
- 2 Year Limited Warranty

1282474 \$1,149<sup>99</sup> EA

### ELITE MODEL 1

- The battery operated Elite offers 4-8 hours of court time
- Designed for easy transportation to and from your court
- Elite provides 80mph ground strokes, sky-high lobs, corner-to-corner random oscillation and a heavy spin
- 150 ball capacity
- Will challenge a variety of players from advanced to beginners
- 2 Year Limited Warranty

1154733 \$1,599<sup>99</sup> EA

### ELITE MODEL 2

- Same great features as the Lobster Elite Model 1 but with triple oscillation
- Most machines sweep randomly left to right, but the Elite Model 2 also oscillates vertically, giving you short and deep shots in a random pattern
- Simulates actual match play
- 2 Year Limited Warranty

1154740 \$1,899<sup>99</sup> EA

### ELITE MODEL 3

- Same great features as the Lobster Elite Model 1 and Model 2 but with two versatile, pre-programmed options for narrow and wide forehand and backhand sweeping shots
- The Elite 3 offers an unmatched tennis experience for simulating actual match play
- 2 Year Limited Warranty

1154757 \$2,199<sup>99</sup> EA



## ELITE BATTERY-POWERED TENNIS BALL MACHINES

Holds 150 Tennis Balls

### WIRELESS REMOTE CONTROL



- Control your Lobster Elite training regimen with the battery 2-function remote control
- Controls both feed and sweep of unit
- **Must be factory installed**

1154788 \$299<sup>99</sup> EA

### PREMIUM FAST CHARGER



- Premium Fast Charger will have your Lobster Elite ready for play in only 1-3 hours
- "Trickle" charge feature guarantees you'll never overcharge your battery
- **Must be factory installed**

1154764 \$199<sup>99</sup> EA

### FAST CHARGER

- Fast Charger will have your Lobster Elite ready for play in 4 hours or less
- "Trickle" charge feature guarantees you'll never overcharge your battery
- **Must be factory installed**

1154771 LOB-STER® Fast Charger



\$149<sup>99</sup> EA

### ELITE STORAGE COVER

- Vinyl cover helps protect your Elite machine from dust, moisture, and any other outdoor elements

1154795 Storage Cover

\$69<sup>99</sup> EA



**advantage**  
SPORT EQUIPMENT  
the perfect match

### SANDFILLED COLOR CONCENTRATE

- 100% acrylic binder and color pigment for final color coats over properly prepared asphalt and concrete pavements
- Supplied in concentrated form-all you add is water
- A 5 gallon pail produces 7 gallons of paint with the addition of 2 gallons of water
- A typical court requires 100 gallons of SandFilled Color for the recommended two coat application
- Dries in one hour and is ready for play in 24 hours
- Please specify color from chart below

1239089 5 Gallon Pail-Weights 48 lbs.  
1239096 55 Gallon Drum-Weights 556 lbs.

\$209<sup>22</sup> EA **SAH**  
\$1,799<sup>22</sup> EA **SAH**



**advantage**  
SPORT EQUIPMENT  
the perfect match

### CRACK REPAIR

- A colored acrylic latex, fortified with mineral fillers, fibers and silica sand
- Designed to be used as a trowel grade repair for larger cracks
- Comes ready to use
- Dries in 2 hours and is ready for play in 24 hours
- Available colors: Red, Turquoise, Light Green, Blue, Dark Green, Gray, Tan and Maroon

1239041 1 Gallon-Weights 16 lbs \$76<sup>22</sup> EA  
1239058 5 Gallon-Weights 80 lbs \$369<sup>22</sup> EA

**advantage**  
SPORT EQUIPMENT  
the perfect match

### ADVANTAGE CRACK FLEX

- A highly flexible, pourable and colored acrylic latex designed for use in small cracks
- Superior adhesion and resiliency provide longer lasting results
- Comes ready to use in squeezable one gallon jugs
- Dries in 2 hours and is ready to play in 24 hours
- Available colors: Dark Green, Light Green, Red, Black and Neutral

1239034 Specify color \$99<sup>22</sup> EA



### APPLICATION SQUEEGEE

- 36"W solvent-resistant "clamp style" aluminum frame
- Reversible neoprene blade - long lasting
- 66"L x 1 1/8"D powder-coated aluminum handle with 6" non-slip vinyl grip
- Wrap around bracing

1239072 \$89<sup>22</sup> EA



**advantage**  
SPORT EQUIPMENT  
the perfect match

### LINE PAINT

- A highly reflective white acrylic paint with texture.
- Designed for use on acrylic coated surfaces or asphalt pavements
- Comes ready to use. Available in white only
- Figure one gallon per tennis court or 450 linear feet per gallon
- Apply by brush, roller or spray
- Dries in one hour and is ready for play in 24 hours

1239065 1 Gallon - 12 lbs. \$84<sup>22</sup> EA

## ADVANTAGE COLORS



**Special Freight Applies**  
Qty 1-3 pails: \$25 per pail  
Qty 4+ and drum orders:  
Call for freight quote

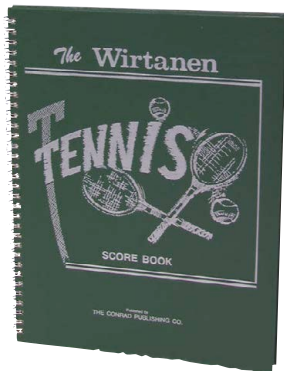

### WIRTANEN TENNIS SCOREBOOK

- Includes: 32 matches, summary sheets, tournament charts, individual player records and instructions.

1303254 \$20<sup>42</sup> EA ★



### QUICK-MARK BOUNDARY MARKERS

- Create boundaries quickly and easily
  - Poly-vinyl, non-skid markers
  - Includes (20) 12 1/2"L x 2"W lines and (4) 12" corners
- Lifetime Warranty**  
Color Options: **Orange, Yellow.**

45085 Specify Color \$65<sup>22</sup> SET OF 24 ★



### ROLL OUT LINE

- Use in place of floor tape
- Vinyl roll will lay flat on a gym floor, outside on the playground or anywhere you need a temporary boundary/court line
- 33'L x 3"W x 1/8" thick

1292138 \$49<sup>22</sup> EA ★



### QUICKSTART MINI AND MAXI NET SYSTEMS

- Portable net systems for a variety of activities and lead-up games, including tennis, badminton and beginner volleyball
- Nets are easy to set up and take down in 2 minutes or less without tools
- Mini Net is constructed of durable round metal tubing and adjusts from 30" - 52" high
- Maxi Net is constructed of durable oval metal tubing and adjusts from 30" to 64" high
- Comes complete with carrying case

<b>20025187</b>	Mini Net - 10'L (Round Tubing)	\$139 <sup>22</sup> EA
<b>20021837</b>	Maxi Net - 18'L (Oval Tubing)	\$159 <sup>22</sup> EA



**Mini Net**      **Mini Net with extensions**



### PORTABLE NET SYSTEM

#### PORTABLE NET SYSTEM

- Portable net system for a variety of games and activities
- Ideal for beginning tennis, badminton & volleyball
- Height adjustable from 32" to 52"
- Comes complete with carrying case

<b>1282450</b>	10'L Model	\$109 <sup>22</sup> EA ★
<b>1282467</b>	18'L Model	\$129 <sup>22</sup> EA ★



**NEW!**

### PICKLENET DELUXE

- Official net height and width (34"H x 22'W)
- Can be used on any flat surface and easily moved
- Powder-coated steel system with 4" locking wheels
- Center-strap design for consistent height
- Adjustment straps on net edge for optimal net tension
- Fast and easy assembly; includes carry bag

<b>1390090</b>	49 lbs	\$299 <sup>22</sup> EA
----------------	--------	------------------------



### PICKLEBALL NET

- Official pickleball height (34") and width (22') net
- Portable, powder-coated steel frame net system
- Center-strap design for consistent height
- Adjustment straps on net edge for excellent net tension
- Fast and easy assembly, with nylon storage bag

**1363633**

\$179<sup>22</sup> EA



### QUICK START MULTINET

- Adjusts 33" to 60" in the middle using telescoping poles
- Built in scoring system for drilling and competition
- Quick set up, light weight and includes storage bag

<b>1377089</b>	18' Long	\$139 <sup>22</sup> EA
<b>1377090</b>	Mini - 9' Long	\$119 <sup>22</sup> EA



### QUICKSTART ROLL-A-NET

- Adjusts from tennis height up to badminton height
- Weather-resistant polyester paint to help avoid rusting with outdoor use
- Easily wheels on and off the court with locking wheels
- Center support wheel with adjustable net tension
- Net rolls up easily and stores in nylon bag with wheels

<b>1377091</b>	\$279 <sup>22</sup> EA
----------------	------------------------



### RACQUET CART

- Galvanized steel construction
- Holds up to 64 tennis rackets or 100 table tennis paddles
- Non-marring casters for easy transport

<b>1690XXX</b>	32"L x 14"W x 28"H	\$79 <sup>22</sup> EA ★
----------------	--------------------	-------------------------

### RACQUET CART

- Stores and transports up to 100 racquets and paddles of all types
- Transport all your badminton or tennis equipment in one trip
- Features a basket for storing tennis balls, shuttlecocks and other accessories

<b>1246131</b>	41"H x 43"W x 19"D	\$21 <sup>29</sup> EA
----------------	--------------------	-----------------------



### RACQUET STORAGE CART

- Powder-coated red steel frame with 3" casters
- Will hold up to 22 tennis racquets or 44 badminton racquets or multiple combinations
- Extra storage below and on ends for balls, nets and other equipment

<b>1297973</b>	45"H x 52"L x 25"D	\$319 <sup>22</sup> EA ★
----------------	--------------------	--------------------------





**Wilson**  
**CHAMPIONSHIP TENNIS BALLS**

• Can of 3 balls - 24 Cans/Case

**MTWILCAN** \$4.22 CAN  
**MTWILCAN24** \$99.22 PACK OF 24



**Penn**  
**CHAMPIONSHIP TENNIS BALLS**

• Can of 3 balls - 24 Cans/Case

**MTPENCAN** \$4.22 CAN  
**MTPENCAN24** \$99.22 PACK OF 24



**DUNLOP**  
**CHAMPIONSHIP TENNIS BALLS**

• Can of 3 balls - 24 Cans/Case

**MTDUNCAN** \$4.22 CAN  
**MTDUNCAN24** \$89.22 PACK OF 24



**Wilson**  
**TEAM PRACTICE TENNIS BALLS**

• Can of 3 balls - 24 Cans/Case

**MTWILBAL** \$3.22 EA  
**MTWILBAL24** \$84.22 PACK OF 24



**Penn**  
**PRACTICE/COACH TENNIS BALLS**

• Can of 3 balls - 24 Cans/Case

**MTPENBAL** \$3.22 CAN  
**MTPENBAL24** \$79.22 PACK OF 24



**RolDri**  
**PRESSURELESS TENNIS BALLS**

• Perfect for practice or recreational tennis

**I704XXXX** \$11.22 DZN ★

## WHAT IS 10 & UNDER TENNIS? (Formerly Quickstart Tennis)

10 & Under Tennis is a program designed to help kids 10 years old and under learn to play the game of tennis. A few changes have been made to encourage learning the game.....The court sizes. The racquet sizes. The ball sizes. The scoring system. Also, the net height. 10 & Under is now part of the USTA Jr. Tennis league and can be a part of every development program. More kids will be able to enjoy this new format and have lots of fun playing with their friends.

AGE	COURT SIZE	RAQUET	BALL	NET HEIGHT	SCORING
8 yrs & under	36' x 18'	up to 23"	foam or very low compression	2' 9"	-Best 2 out of 3 games -Games to 7 points
10 yrs & under	60' x 21' singles 60' x 27' doubles	up to 25"	low compression	3'	-Best 2 out of 3 sets -Games to 7 points -4 Games = Set -3rd Set Tiebreaker to 7 points



**QUICKSTART 36' FOAM BALLS**

- Softball sized foam tennis ball
- Designed for 36-foot QuickStart Tennis Court
- Designed for durability and consistent bounce
- Available in Dozen or case of 12 Dozen

**I376917** Dozen \$46.22 DZN  
**I376918** Case of 144 \$489.22 SET OF 144



**QUICKSTART 60' BALLS**

- Same size as normal tennis balls but bounce about 50% the speed of a regular tennis ball
- Specifically designed for 60-foot QuickStart Tennis court
- Comes in case pack of 24 cans (72 balls)

**I376945** 24 Cans/Case \$119.22 SET OF 72



**QUICKSTART 36' BALLS**

- 15% larger than standard tennis balls
- Specifically designed for 36-foot QuickStart Tennis court
- Increases the success for beginning children
- Comes in a convenient color-coded 30 or 60-ball bucket

**I274189** 30 Ball Bucket \$64.22 SET OF 30  
**I363682** 60 Ball Bucket \$109.22 SET OF 60



**QUICKSTART 78' BALLS**

- Same size as normal tennis balls, but bounce at about 75% the speed of a regular tennis ball
- They are proven to help players of all ages slow down full-court play for maximum improvement
- Comes in case pack of 24 cans (72 balls)

**I376946** 24 Cans/Case \$119.22 SET OF 72







**MacGregor**

**RECREATIONAL**

- Durable aluminum frame with I-Beam design
- Mid-size 95 square inch head size with PU grip
- Perfect for recreational tennis programs
- Available in 4 3/8" or 4 1/2" grip size

**MTSRAQ38** 27"L - 4 3/8" Grip \$15<sup>99</sup> EA ★  
**MTSRAQ48** 27"L - 4 1/2" Grip \$15<sup>99</sup> EA ★



**MacGregor**

**WIDE BODY**

- Lightweight aluminum frame with O-Beam design
- Over-sized 110 square inch head size with PU grip
- Ideal for recreational players of all ages
- Available in 3 grip sizes
- Size: 4 1/4", 4 3/8", 4 1/2".

**MTMRAO** 27"L - Specify Grip Size \$24<sup>99</sup> EA ★



**MacGregor**

**21" YOUTH**

- Durable aluminum frame with I-Beam design
- 90 square inch head size with PU grip
- Ideal racquet for QuickStart tennis
- 4" grip size

**1309478** \$17<sup>99</sup> EA ★



**MacGregor**

**23" JUNIOR SERIES**

- Durable aluminum construction with O-Beam design
- Mid-size 95 sq in. head size, PU grip
- Ideal for your youngest players

**MTTRAQJR** \$18<sup>99</sup> EA ★

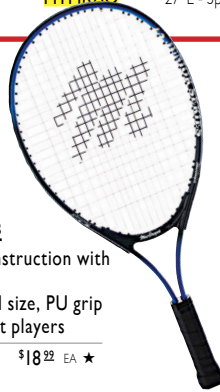

**MacGregor**

**25" YOUTH SERIES**

- Durable aluminum frame with O-Beam design
- Mid-size 95 sq in. head size, PU grip
- Ideal for younger players ages 8 and up

**MTMRAQP** \$19<sup>99</sup> EA ★

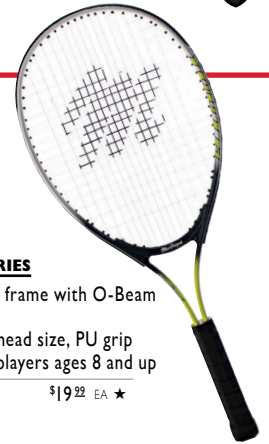

**Wilson ENERGY™ XL**

- V-Matrix™ Technology for larger sweet spot
- 10.3 oz strung weight(291g)
- 4 3/8" grip size

**1388070** 27.5"L \$29<sup>99</sup> EA



**Wilson TOUR SLAM™**

- Volcanic frame technology for power and stability
- 11.5 oz strung weight(326g)
- 4 3/8" grip size

**1388071** 27.25"L \$34<sup>99</sup> EA



**Wilson FEDERER**

- Features Arc Technology for greater stability
- 10.4 oz strung weight(295g)
- 4 3/8" grip size

**1388072** 27.25"L \$39<sup>99</sup> EA



**TOURNA GRIP® RACQUET GRIPS**

- Extremely durable and well cushioned for maximum comfort and performance
- Use with all tennis, badminton, squash and racquetball racquets
- Sold in package of 30 grips

**1065190** \$49<sup>99</sup> PACK OF 30

**HEAD SPEED 25**

- 107 square inch head that weighs only 7.4 oz.
- Junior racquet for ages 8 and up
- 3 7/8" synthetic grip

**20026540** 25"L \$22<sup>99</sup> EA



**HEAD TOUR PRO**

- Features an oversize durable aluminum alloy head and weighs only 9.7 oz.
- Perfect racquet for the recreational tennis player
- 4 3/8" grip size

**1377079** 27"L \$28<sup>99</sup> EA



**HEAD TI RADICAL ELITE**

- Features an oversize titanium technology head and weighs only 10.4 oz.
- Fused graphite for extra feel and power
- Extra long length for added reach
- 4 3/8" grip size

**1377080** 27"L \$44<sup>99</sup> EA



### PORTABLE BADMINTON GAME STANDARDS

- 2 3/8" OD Flo-coated® galvanized standards
- 24"D steel base with rubber floor protector
- Roll-away wheels, no floor plates necessary
- Includes economy badminton net
- Blue only

**STBMNSTD** 160 lbs. \$469<sup>22</sup> PR ★

### PROTECTIVE BASE PAD

- Vinyl covered bonded foam
- Easy to install with hook-and-loop attachments
- Blue only

**1012385** \$109<sup>22</sup> EA ★



### COMPETITION BADMINTON STANDARDS

- Galvanized steel with gray hammertone powder coated finish
- Stable T-base design
- Rubber floor protectors
- Includes collegiate badminton net

**STBMNXXX** 175 lbs. \$539<sup>22</sup> PR ★



## Gold Medal **BADMINTON NETS**

CODE	MODEL	USE	NET	HEADBAND	CABLE	BOTTOM & SIDETAPES	PRICE
<b>MACBMNET</b>	PROFESSIONAL 21' x 2.5'	Competition	Weather treated knotless nylon	White HD vinyl	1/4" poly rope	Vinyl coated nylon	\$42 <sup>22</sup> EA ★
<b>SNBMNCOL</b>	COLLEGIATE 21' x 2.5'	Intramurals	3/4" mesh nylon	Vinyl coated nylon	Braided nylon - 4mm	Double stitched nylon	\$30 <sup>22</sup> EA ★
<b>SNBMNI28</b>	ECONOMY 21' x 2.5'	Recreational	Knotted poly-fiber 3/4" mesh	PVC Vinyl 3mm braided nylon	Braided nylon - 3mm	Single stitched vinyl	\$20 <sup>22</sup> EA ★



### **Carlton**

#### SHUTTLECOCKS

- Designed for slow speed/high altitude, medium speed/normal or fast speed/warm conditions
- Sold in tubes of 6
- Weight: 5 grams each

<b>T800WHGR</b>	Slow/High Altitude	\$14 <sup>22</sup> TUBE
<b>T800WHBL</b>	Medium/Normal	\$14 <sup>22</sup> TUBE
<b>T800WHRD</b>	Fast/Warm	\$14 <sup>22</sup> TUBE
<b>T900WHBL</b>	F2 - Medium/Normal	\$17 <sup>22</sup> TUBE



### **MacGregor**

#### TOURNAMENT SHUTTLECOCKS

- Medium speed with nylon feathers and cork tip
- Sold in tubes of 6

<b>1. MSBIRDNY</b>	White	\$10 <sup>22</sup> SET OF 6 ★
<b>2. MSBIRDYL</b>	Yellow	\$10 <sup>22</sup> SET OF 6 ★
<b>ECONOMY SHUTTLECOCKS</b>		
• White, plastic feathers with rubber tip		
<b>3. B55-20026545</b>		\$17 <sup>22</sup> SET OF 36 ★
<b>MSBIRDPG</b>		\$49 <sup>22</sup> SET OF 144 ★



### Game Craft

#### BADMINTON SET

- Includes: 4 nylon strung tempered steel racquets, 1" D steel poles, 2 ground sleeves, 2 shuttlecocks, 2 1/2'H x 20'L net and carry bag

**1651XXXXY**

\$30<sup>22</sup> SET ★

## MacGregor



### CHAMP

- Aluminum head with T-joint, graphite shaft
- Nylon close string, PU grip
- Strung weight: 85 grams
- Length: 26"

MSRAQCHA \$22<sup>99</sup> EA ★



### SURVIVOR

- Aluminum head, tempered steel shaft
- Coated steel string, PU grip
- Strung weight: 100 grams
- Length: 26"

MSRAQ711 \$19<sup>99</sup> EA ★



### TOURNAMENT 110

- Aluminum head, tempered steel shaft
- Nylon close string, PU grip
- Strung weight: 95 grams
- Length: 26 1/2"

BSNRQ110 \$14<sup>99</sup> EA ★



### TWIN 200

- Durable steel head and twin shaft racquet
- Two-tone color with vinyl PU grip
- Strung weight: 165 grams
- Length: 25 1/2"

1143294 \$10<sup>99</sup> EA ★



### ECONOMY YOUTH

- Tempered steel, painted head and shaft
- Simulated leather grip
- Recommended for ages 12 and under
- Strung weight: 130 grams
- Length: 25"

BSNRQECO Single Racquet \$6<sup>99</sup> EA ★  
20026544 Set of 10 \$59<sup>99</sup> KIT OF 10 ★

## Carlton



### MAXI BLADE 4.3

- Titanium alloy head with steel shaft
- Ideal racquet for recreational play
- Strung weight: 105 grams
- Length: 26"

20026541 \$21<sup>99</sup> EA



### AEROBLADE 3000

- Isometric Titanium Alloy head
- Tempered Steel Shaft for power and durability
- Ideal racquet for recreational play
- Strung weight: 100 grams
- Length: 26"

1376932 \$17<sup>99</sup> EA



### AEROBLADE 2000

- Tempered steel for durability
- Isometric shape head
- Ideal economy recreational racquet
- Strung weight: 120 grams
- Length: 26"

1376933 \$14<sup>99</sup> EA

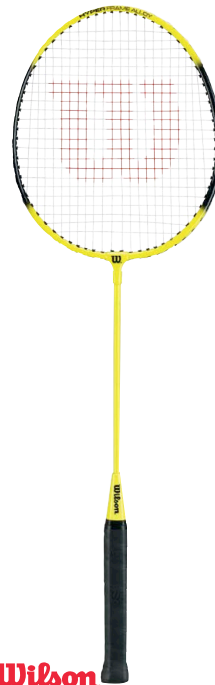

### Wilson MATCHPOINT

- Two piece aluminum frame and flared inside grommets for maximum durability
- Oversized 53 square inch sweet spot
- Strung weight: 120 grams
- Length: 26"

1310122 \$14<sup>99</sup> EA



### ONE-PIECE BADMINTON RACQUET

- One-piece molded racquet
- Lightweight flexible design
- Weight: 130 grams
- Length: 25 1/2"

MSRAQZYT \$12<sup>99</sup> EA



**NEW!**

**DUNLOP**

**FORCE TI**

- Alloy construction
- Weight: 195g
- Head Size: 500 sq. cm
- String Pattern: 14 x 19

**1390098**

\$25<sup>22</sup> EA



**DUNLOP**

**AEROLITE TI**

- Made with high impact Titanium/Alloy Construction for durability
- PowerMax String Pattern for additional power from string bed
- Built-in Vibration for added comfort

**1384347**

\$28<sup>22</sup> EA



**NEW!**

**DUNLOP**

**BLAZE PRO**

- Graphite Alloy construction
- Weight: 180g
- Head Size: 500 sq. cm
- String Pattern: 14 x 20

**1390099**

\$34<sup>22</sup> EA

**I-ARMOR PROTECTIVE SQUASH EYEWEAR**



- Designed with an ergonomic profile for extra stability and contoured lens shape for peripheral vision
- The only squash eyewear approved by the World Squash Federation

**1371548**

\$29<sup>22</sup> EA

**PRO DOUBLE DOT SQUASH BALL**

- Ball is best suited for advanced & serious players.
- The official ball of the WSF (World Squash Federation) and the PSA (Professional Squash Association).
- Low bounce



**1371546**

dozen

\$47<sup>22</sup> EA

**COMPETITION SQUASH BALL**

- Ball provides great performance and great value for club and intermediate play
- Standard size with a 10% longer hang-time to that of the Dunlop Pro Squash Ball.



**1371547**

Dozen

\$41<sup>22</sup> EA

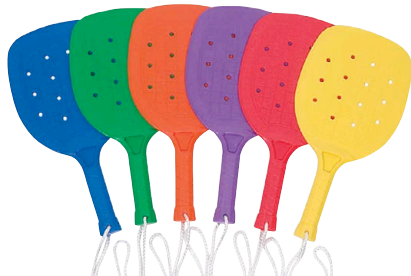

**PLASTIC MOLDED PADDLES**

- Tough one-piece molded paddles for elementary and junior high players
- Junior size (elementary) measure 13 5/8" L x 6 1/2" W - weigh 7 oz.
- Youth size (junior high) measure 16" L x 7 1/2" W - weigh 12 oz.
- Color Options: **Blue, Green, Orange, Purple, Red, Yellow.**

**1197778**

Junior Size - Specify Color

\$9<sup>22</sup> EA ★

**1197839**

Youth Size - Specify Color

\$10<sup>22</sup> EA ★



**MacGregor**

**PADDLEBALL RACQUET**

- Features 7-ply laminated 9mm wood construction, 50 hole face, double-riveted wooden handle, leather grip and leather wrist strap
- 15 3/4" L x 8" W

**MSPBRDLX**

\$16<sup>22</sup> EA ★



**USHA 21" HANDBALL**

- Exclusively USHA endorsed
- 1 ball per can

**1553XXXX**

\$9<sup>22</sup> CAN



**HEAD IMPULSE**

- Ultra lightweight design with adjustable strap
- Anti-fog treated with shatterproof polycarbonate lenses

**1238983**

\$12<sup>22</sup> EA



**EYE PROTECTORS**

- Durable, lightweight plastic with adjustable strap
- One size fits all

**1720XXXX**

\$9<sup>22</sup> EA ★



**DELUXE EYE PROTECTORS**

- High impact polycarbonate, scratch resistant lenses
- Durable cushioned nose piece
- Non fogging

**1723XXXX**

\$14<sup>22</sup> EA ★



**OVERGLASS PROTECTORS**

- Durable, lightweight plastic
- Fits right over your own prescription glasses
- Protects eyes, nose and temples while providing maximum visibility

**1721XXXX**

\$21<sup>22</sup> EA ★

## RACQUETBALLS

**SAVE 15%  
WHEN YOU BUY  
A CASE!**

**Penn**

### ULTRA BLUE RACQUETBALL

- The World's #1 Selling Racquetball
- Ultra blue racquetball gives long, lively, and consistent play
- Microscopic texturization for extra bite

**I555XXXX** Can of 3 \$5.82 CAN  
**I555CASE** 24 Cans \$121.22 CASE OF 24

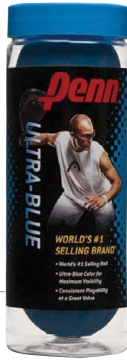

**Penn**

### PRO GREEN RACQUETBALL

- The official ball of USA Racquetball makes the Pro Penn the most widely used ball in tournament play.
- Bright green color has a great on-court visibility.
- Consistent speed, playability and durability

**I556XXXX** Can of 3 \$6.22 CAN  
**I556CASE** 24 Cans \$139.22 CASE OF 24



**Penn**

### HIGH DEFINITION RACQUETBALL

- Penn's new HD High Definition racquetball.
- Optimum on-court visibility
  - Faster, livelier and consistent playability
  - Lighter weight for a more comfortable feel
  - Increased durability

**I557XXXX** Can of 3 \$7.22 CAN  
**I557CASE** 24 Cans \$149.22 CASE

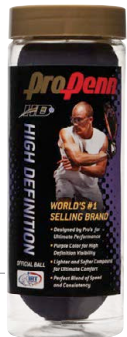

**12 BALLS  
PER CAN**

**Penn**

### 12-BALL CANISTER

- The world's #1 selling racquetball
- Ultra blue color offers added visibility
- Ideal for all levels of play

**I238976** \$25.22 CAN



## MacGregor RACQUETS

### 1. MASTER

- Lightweight, graphite composite O-Beam frame
- Mid-size 107 sq in. head with built-in bumper and string guards
- Soft 4" PU grip
- Weight: 258 grams

**MSRBRMAS** 21" L \$27.22 EA ★

### 2. COLLEGIATE

- Tear drop head with I-Beam frame
- Built-in bumper with open throat design, 105 sq in. head
- Soft 4" PU grip
- Weight: 220 grams

**MSRBRDLX** 22" L \$20.22 EA ★

### 3. SCHOLASTIC

- Powder coated aluminum finish
- Tear drop head with built in bumper
- Soft 4" PU grip
- Weight: 255 grams

**MSRBRECO** 22" L \$17.22 EA ★



## E-FORCE RACQUETS

### 1. CHAOS 15/16

- Quadraform Head Shape
- Patented Zero Richter Tubes
- Patented Bypass Stringing System
- Monster String Holes
- 22" LongString® Technology
- 3-15/16" Grip Size

**I384357** 22" L \$62.22 EA

### 2. VOLCANO

- Thick, reinforced frame
- Extremely Durable
- Platinum 16 gauge string
- 22" LongString® Technology
- Tri-Tear Head Shape
- 3-15/16" Grip Size

**I384356** 22" L \$26.22 EA



## HEAD RACQUETS

### 1. MX CYCLONE

- Metallix alloy provides a stronger, lighter, stiffer and more powerful construction
- Pyramid V PowerZone String Pattern
- Head Size 106.5 sq. in. - Grip Size 3-5/8"
- Weight - 190 grams

**I384305** 22" L \$34.22 EA

### 2. MX FIRE

- Metallix alloy provides a stronger, lighter, stiffer and more powerful construction
- PowerZone String Pattern
- Head Size 106.5 sq. in. - Grip Size 3-5/8"
- Weight - 200 grams

**I384306** 22" L \$24.22 EA





**BRINE PHANTOM**

- Hand Stitched,
- Shiny, abrasion resistant PU cover
- Exclusive Brine B.E.A.R. bladder system holds air 10X Longer than normal Latex

**3 Year Limited Warranty**  
Color Options: **Black, Royal, Scarlet.**

**1378542** Size 5 - Specify Color \$49<sup>22</sup> EA



**BRINE VORACITY**

- Soft PU cover
- Hand stitched
- Exclusive Brine B.E.A.R. bladder system holds air 10X Longer than normal Latex

**2 Year Limited Warranty**  
Color Options: **Black, Royal, Scarlet.**

**1378532** Size 5 - Specify Color \$35<sup>22</sup> EA



**BRINE ATTACK**

- Highly durable PVC cover
- Butyl bladder
- Hand stitched

Color Options: **Black, Royal, Scarlet.**

**1378536** Size 5 - Specify Color \$17<sup>22</sup> EA



**395 BLUR**

- UA Touchskin™ Technology with TPU cover
- EVA foam layer and wrapped bladder
- Machine stitched

**1388052** Size 5 - White \$21<sup>22</sup> EA

**1388051** Size 4 - Yellow \$21<sup>22</sup> EA

**1388050** Size 3 - Orange \$21<sup>22</sup> EA



**BRINE CHAMPIONSHIP**

- Hand Stitched
- Premium glossy PU cover
- Exclusive Brine B.E.A.R. bladder system holds air 10X Longer than normal Latex

**3 Year Limited Warranty**  
**1378541** Size 5 - Black/White \$69<sup>22</sup> EA



**PERFECTION® ELITE**

- Premium teijin microfiber
- Hand-sewn
- Official Ball of NJCAA

**3 Year Limited Warranty**

**1301304** Size 5 \$79<sup>22</sup> EA



**SELECT NUMERO 10**

- 1.5 mm PU cover with zero wing latex bladder
- Hand-sewn; includes Player # panel
- Solid White available in size 4 & 5
- Color Options: Forest, Gold, Orange, Red, Royal, Yellow

**2 Year Limited Warranty**  
**1342079** White - Specify Size 4 or 5 \$36<sup>22</sup> EA

**1377036** Size 5 Only - Specify Color \$36<sup>22</sup> EA



**SELECT ROYALE**

- 1.8 mm PU construction with zero wing latex bladder
- Hand-sewn
- Color options: Black, Forest Green, Maroon, Navy, Orange, Red, Royal, White, Yellow

**2 Year Limited Warranty**  
**1377023** Size 5 - Black/White \$56<sup>22</sup> EA

**1377024** Size 5 - Specify Color \$56<sup>22</sup> EA



**SELECT THOR**

- 1.2 mm PU cover with zero wing latex bladder
- Includes Player # panel
- Hand-sewn

**2 Year Limited Warranty**

Size: **4, 5.**  
**1377043** Specify Size - Black/White \$29<sup>22</sup> EA



**SELECT CLASSIC**

- Newly developed PVC composite with improved softness
- True bounce and long durability
- Butyl bladder for better air retention
- Machine stitched
- Sizes 5 - Wht/Navy; Size 4 - Wht/Red; Size 3 - Wht/Green

Size: **3, 4, 5.**  
**1388580** Specify Size/Color \$17<sup>22</sup> EA



**SELECT UNITED**

- PU cover with butyl bladder
- Includes Player # panel
- Hand-sewn

**2 Year Limited Warranty**

Size: **3, 4, 5.**  
**1377046** Specify Size - Blue/White \$22<sup>22</sup> EA



**SELECT DIAMOND**

- Hand-sewn PU cover
- Newly developed backing layer provides softer feel and touch
- Patented Zero-Wing latex bladder for optimal bounce
- Size 5 - Red; Size 4 - Blue

Size: **4, 5.**  
**1388597** Specify Size/Color \$31<sup>22</sup> EA



**YMCA HERITAGE**

- Soft PVC cover
- Machine stitched

<b>1384325</b>	Size 5 - Silver	\$14 <sup>99</sup> EA ★
<b>1384326</b>	Size 4 - Black	\$14 <sup>99</sup> EA ★
<b>1384327</b>	Size 3 - Red	\$14 <sup>99</sup> EA ★



**NFHS<sup>®</sup>**  
APPROVED

**MacGregor**  
**Euro 32**

- Soft PVC cover
  - Machine stitched
  - NFHS approved (size 5)
- Size: 4, 5.

<b>70200225</b>	Specify Size	\$22 <sup>99</sup> EA ★
-----------------	--------------	-------------------------



**MacGregor**  
**World Class**

- High gloss cushioned urethane cover
- Machine stitched

<b>1235586</b>	Size 5 - Blue	\$18 <sup>99</sup> EA ★
<b>1235579</b>	Size 4 - Orange	\$18 <sup>99</sup> EA ★
<b>1235562</b>	Size 3 - Green	\$18 <sup>99</sup> EA ★



**NFHS<sup>®</sup>**  
APPROVED

**Wilson**  
**NCAA AVANTI**

- Official championship match ball of NCAA<sup>®</sup> soccer
- Hand stitched top-grade composite leather cover
- SBR foam backed 32 panel construction

<b>1384473</b>	Size 5	\$69 <sup>99</sup> EA
----------------	--------	-----------------------



**MacGregor**  
**MERCURY CLUB**

- Soft PVC cover
- Machine stitched

<b>70200235</b>	Size 5 - Blue	\$15 <sup>99</sup> EA ★
<b>70200234</b>	Size 4 - Red	\$15 <sup>99</sup> EA ★
<b>70200233</b>	Size 3 - Green	\$15 <sup>99</sup> EA ★



**MacGregor**  
**CLASSIC 32**

- Soft PVC cover
  - Machine stitched
- Size: 3, 4, 5.

<b>MCS30005</b>	Specify Size	\$16 <sup>99</sup> EA ★
-----------------	--------------	-------------------------



**Wilson**  
**NCAA COPIA DUE**

- Synthetic, composite cover
  - Machine sewn
- Size: 4, 5.

<b>1369571</b>	Specify Size	\$19 <sup>99</sup> EA
----------------	--------------	-----------------------



**NFHS<sup>®</sup>**  
APPROVED

**Wilson**  
**NCAA STIVALE II**

- Composite TPU cover
- EVA foam backed panels
- Machine stitched

<b>1388018</b>	Size 5	\$34 <sup>99</sup> EA
----------------	--------	-----------------------



**NFHS<sup>®</sup>**  
APPROVED

**Wilson**  
**NCAA FORTE FYBRID**

- High performance composite leather cover
- Fused panels backed with G10 foam
- FIFA, NCAA and NFHS approved

<b>1366488</b>	Size 5	\$99 <sup>99</sup> EA
----------------	--------	-----------------------



**AEROW TEAM**

- Traditional 32-panel design
  - Machine-stitched TPU
  - Reinforced rubber bladder enhances shape retention
- Size: 3, 4, 5.

<b>1375368</b>	Specify Size	\$19 <sup>99</sup> EA
----------------	--------------	-----------------------



**NFHS<sup>®</sup>**  
APPROVED

**PREMIER TEAM**

- High quality PU cover
  - Hand stitched
- Size: 4, 5.

<b>1376985</b>	Specify Size	\$39 <sup>99</sup> EA
----------------	--------------	-----------------------



**NFHS<sup>®</sup>**  
APPROVED

**CATALYST**

- Premium PU cover
- Machine stitched

<b>1376984</b>	Size 5	\$59 <sup>99</sup> EA
----------------	--------	-----------------------

# SELECT PACKS



## BRILLIANT SUPER PACKAGE - 6/PACK

- New cutting edge design that improves the best ball in the world
- Teijin microfiber PU cover with 3 layer underlining
- Patented zero wing latex bladder
- 32 hand crafted panels that ensures true flight
- NFHS/NCAA/FIFA Approved
- Color: White/Black/Silver/Gold
- Includes ball bag

**3 Year Limited Warranty**

1388095      Size 5      \$499<sup>22</sup> PACK



## ROYALE - 10 PACK

- NFHS/ NCAA approved - Hand Sewn
- 1.8 mm PU cover with zero wing latex bladder
- Includes ball bag

**3 Year Limited Warranty**

Color Options: **White/Black, White/Royal.**

1377033      Size 5 - Specify Color      \$429<sup>22</sup> SET



## NUMERO 10 WHITE - 10 PACK

- NFHS/ NCAA approved - Hand Sewn
- 1.5 mm PU cover with zero wing latex bladder
- Includes player # panel
- Size 4 & 5 - Includes ball bag

**2 Year Limited Warranty**

1378556      Specify Size      \$279<sup>22</sup> SET



## THOR - 10 PACK

- NFHS/NCAA Approved - Hand Sewn
- 1.2 mm microfiber PU cover with zero wing bladder
- Includes players # panel
- Color: White/Black
- Includes ball bag

**2 Year Limited Warranty**

Size: **4, 5.**

1377065      Specify Size      \$229<sup>22</sup> SET



## CLUB - 10 PACK

- The best practice ball on the market for the price
- 0.6 mm microfiber PU cover with zero wing latex bladder
- Includes ball bag
- Includes NEW players # panel

**1 Year Limited Warranty**

Size: **3, 4, 5.**

1379260      Specify Size      \$209<sup>22</sup> SET



## NUMERO 10 YELLOW - 10 PACK

- High visibility yellow Numero 10
- NFHS/NCAA approved - Hand Sewn
- 1.5 mm PU cover with zero wing latex bladder
- Includes ball bag

**2 Year Limited Warranty**

1377095      Size 5      \$279<sup>22</sup> SET

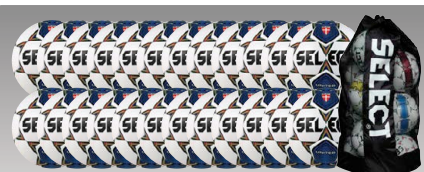

## UNITED - 24 PACK

- 24 Top training balls - Hand Sewn
- PU cover with butyl bladder for long air retention
- Includes NEW players # panel
- Size 3, 4 & 5 - Includes ball bag

**1 Year Limited Warranty**

1377050      Specify Size      \$369<sup>22</sup> SET



## FUTSAL MASTER - 6/PACK

- The perfect Futsal match ball
- 1.5 mm PU cover - excellent touch and feel
- Low bounce - high visibility neon green
- Includes ball bag

**2 Year Limited Warranty**

1388096      Size Sr.      \$289<sup>22</sup> PACK



## FUTSAL JINGA - 6 PACK

- SELECTS most popular futsal ball
- FPU5 1300 material - butyl bladder for long air retention
- Low bounce for perfect control
- Includes ball bag

**1 Year Limited Warranty**

1388097      Size Sr.      \$184<sup>22</sup> PACK



## FUTSAL FLASH - 6/PACK

- Neoprene foam backing with memory effect
- Soft PU cover for good control
- Low bounce - high visibility orange
- Includes ball bag

**1 Year Limited Warranty**

1388098      Size Sr.      \$124<sup>22</sup> PACK



## OVER-VEST TRAINING BIB - SET OF 12/COLOR

- Comfortable and cost efficient
  - 100% ploy mesh
  - Horizontal panel is convenient for logo screening
- Color Options: **Blue, Green, Orange, Pink, Red, Yellow**
- Size: **Junior, Senior.**

1375351      Specify Color/Size      \$57<sup>22</sup> DZN



## COSMO - 10/PACK

- Newly developed PVC composite with improved softness
- True bounce and long durability
- Butyl bladder for better air retention
- Size 3, 4 & 5 - Includes ball bag

**1 Year Limited Warranty**

1388585      Specify Size      \$159<sup>22</sup> PACK



**RUBBER/SYNTHETIC**



**Voit RUBBER BALL**

- Waterproof for fun outdoor play
- Size: 3, 4, 5.

VCS33XXX Specify Size \$11.99 EA ★



**MacGregor RUBBER BALL**

- Best value playground soccer ball anywhere
- Extended-life molded construction
- Size: 3, 4, 5.

MCSBR5XX Specify Size \$9.99 EA ★



**MacGregor MOLDED SYNTHETIC**

- Nylon wound to ensure shape retention
- Stay-round and inflated butyl bladder
- Size: 3, 4, 5.

MCLS303X Specify Size \$15.99 EA ★

**FUTSAL**

**NEW!**



**SELECT FUTSAL MAGICO**

- FPUG 1100 synthetic grain PU material
- Low bounce for perfect control
- Butyl bladder for better air retention
- Senior & Junior size available
- Size: Junior, Senior.

I388114 Specify Size \$31.99 EA

**NEW!**



**BRINE EVOLUTION FUTSAL**

- Durable synthetic cover
- Machine stitched

I388579 Size Sr. \$25.99 EA



**MacGregor LIMITED**

- PVC soft cover
- Machine stitched

I262698 Size Sr. \$19.99 EA ★

**INDOOR**



**BRINE VORACITY INDOOR**

- Seam-saving, microfiber, composite cover
- No-suff gym floor suede finish

I384309 Size 5 \$27.99 EA



**MacGregor EUROFELT INDOOR**

- Felt cover construction
- Machine stitched

MCSFELT5 Size 5 \$26.99 EA ★

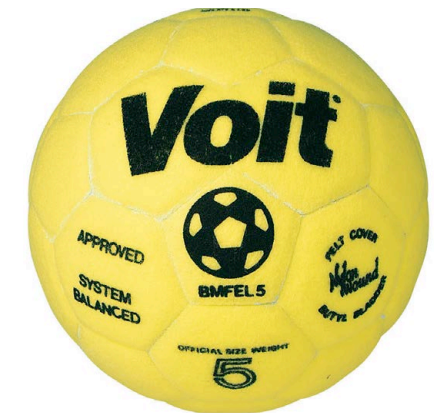

**Voit INDOOR FELT**

- Nylon wound, molded felt cover
- Soft kick feel for virtually painless play
- Size: 4, 5.

VSBMFEL5 Specify Size \$23.99 EA ★

## SOCCER NETS

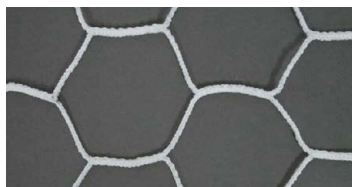

ORANGE



WHITE

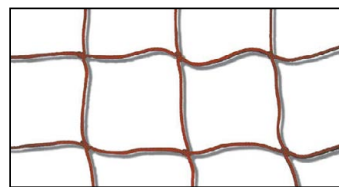

CODE	SIZE	BODY	RECOMMENDED USE	COLOR	PRICE
<b>SN383PROY</b>	8'H x 24'W x 5'D x 10'B	5.0 mm braided PE	College & Pro	Orange	\$279 <sup>22</sup> PR ★
<b>SN383PROW</b>	8'H x 24'W x 5'D x 10'B	5.0 mm braided PE	College & Pro	White	\$279 <sup>22</sup> PR ★
<b>I248876</b>	8'H x 24'W x 4.5'D x 10'B	4.0 mm braided PE-Hexagonal	College & Pro	Black/White	\$249 <sup>22</sup> PR ★
<b>I367770</b>	8'H x 24'W x 3'D x 5'B	4.0 mm braided PE-Hexagonal	College & Pro	Black/White	\$249 <sup>22</sup> PR ★
<b>I397773</b>	8'H x 24'W x 3'D x 8.5'B	4.0 mm braided PE-Hexagonal	College & Pro	Black/White	\$249 <sup>22</sup> PR ★
<b>I367769</b>	8'H x 24'W x 3'D x 8.5'B	4.0 mm twisted knotted PE	College & Pro	White	\$249 <sup>22</sup> PR ★
<b>I367768</b>	7'H x 21'W x 3'D x 7.5'B	4.0 mm twisted knotted PE	Club/Recreational	White	\$199 <sup>22</sup> PR ★
<b>I367767</b>	6.5'H x 18.5'W x 2'D x 7'B	4.0 mm twisted knotted PE	Club/Recreational	White	\$179 <sup>22</sup> PR ★
<b>I367766</b>	6.5'H x 12'W x 2'D x 7'B	4.0 mm twisted knotted PE	Club/Recreational	White	\$159 <sup>22</sup> PR ★
<b>I054729</b>	8'H x 24'W x 4'D x 8'B	3.0 mm twisted knotted PE	High School/Club	White	\$229 <sup>22</sup> PR ★
<b>I054678</b>	7'H x 21'W x 4'D x 8'B	3.0 mm twisted knotted PE	Club/Recreational	White	\$174 <sup>22</sup> PR ★
<b>I054682</b>	6.5'H x 18.5'W x 3'D x 6'B	3.0 mm twisted knotted PE	Club/Recreational	White	\$164 <sup>22</sup> PR ★
<b>I054699</b>	6.5'H x 12'W x 3'D x 6'B	3.0 mm twisted knotted PE	Club/Recreational	White	\$144 <sup>22</sup> PR ★
<b>I367772</b>	4.5'H x 9'W x 2'D x 4.5'B	3.0 mm twisted knotted PE	Club/Recreational	White	\$129 <sup>22</sup> PR ★
<b>I054705</b>	4.5'H x 9'W x 2'D x 4'B	3.0 mm twisted knotted PE	Club/Recreational	White	\$124 <sup>22</sup> PR ★
<b>I367771</b>	4'H x 6'W x 2'D x 4'B	3.0 mm twisted knotted PE	Club/Recreational	White	\$114 <sup>22</sup> PR ★
<b>I054712</b>	4'H x 6'W x 2'D x 4'B	3.0 mm twisted knotted PE	Club/Recreational	White	\$99 <sup>22</sup> PR ★
<b>SN383SNRY</b>	8'H x 24'W x 5'D x 10'B	3.0 mm twisted PE	High School/Club	Orange	\$134 <sup>22</sup> PR ★
<b>SN383SNRW</b>	8'H x 24'W x 5'D x 10'B	3.0 mm twisted PE	High School/Club	White	\$134 <sup>22</sup> PR ★
<b>I033526</b>	8'H x 24'W x 5'D x 10'B	2.5 mm twisted PE	Recreational	Orange	\$104 <sup>22</sup> PR ★
<b>SN383ECOW</b>	8'H x 24'W x 5'D x 10'B	2.5 mm twisted PE	Recreational	White	\$104 <sup>22</sup> PR ★
<b>SN7X212M</b>	7'H x 21'W x 3'D x 8'B	3.0 mm twisted PE	Junior Goals	Orange	\$99 <sup>22</sup> PR ★

**SPIKE WITH CABLE LANYARD**

- 14" galvanized spike
- 4 per goal required

**SGSPIKE**\$29<sup>22</sup> EA ★**TWIST-IN NET HOOKS**

- Color: White

**STNTCLIP**

\$0.75 EA ★

**STNETCLP**\$34<sup>22</sup> 50/SET ★**HOOK & LOOP NET STRAPS**

- 16" straps for 3" diameter and larger items
- 11" straps for 2" diameter and smaller items

**I033502**White - 16" \$47<sup>22</sup> SET OF 24 ★**I368869**White - 11" \$37<sup>22</sup> SET OF 24 ★**SCREW-IN NET HOOKS**

- Set of 50

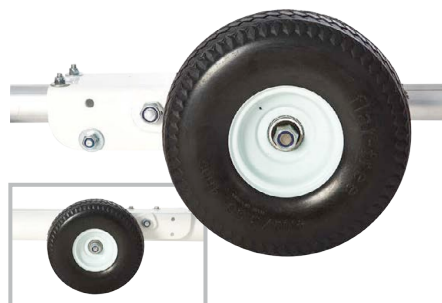
**MSBNETHK**\$29<sup>22</sup> SET OF 50 ★**FLIP OVER WHEEL SET**

- NO-FLAT wheels attach to any backstay up to 2" O.D.
- Also compatible with Alumagoal SGA400, SGA401, SGA402, SGA403 Soccer Goals
- Sold in sets of (2) wheels
- Two sets are required for a pair of goals

**SCGWHLXX**\$179<sup>22</sup> SET OF 2 ★**ALUMIGOAL PERMANENT GROUND ANCHORS**

- 12" long; 2" O.D galvanized steel
- 4 anchors per goal required

**ZSTSPANCHX**\$29<sup>22</sup> EA ★**ALUMIGOAL AUGER STYLE GROUND ANCHOR**

- 12" long; 12 mm O.D. galvanized steel rod
- 4 anchors per goal required

**SGAUGER**\$19<sup>22</sup> EA ★**SAND BAGS**

- Holds 50 lbs. of sand (not included)
- Heavy duty pvc handle for easy carrying
- Zipper closure

**I336542**

22" x 15"

\$72<sup>22</sup> SET OF 4 ★



**FREE NETS & GROUND ANCHORS INCLUDED**

**ALUMIGOAL**  
**4" ROUND CLASSIC ALUMAGOAL**



- Official size 8'H x 24'W x 3'D x 9'B
- Meets NCAA, NFSHSA and FIFA specs
- Front face is 4" round, powder coated custom aluminum extrusion for superior strength
- Backstays are 2" round powder coated aluminum
- Rear crossbars are 2" round galvanized steel
- Built-in net clip track with clips
- Includes 4mm white nets and ground anchors
- 360 lbs./pr

<b>SGA400</b>	Complete Unit	\$2,899 <sup>22</sup> PR ★
<b>SCGWHLXX</b>	Flip Over Wheel Kit - 1 Pr/Set	\$179 <sup>22</sup> SET ★
<b>I367769</b>	4mm - Replacement Net	\$249 <sup>22</sup> PR ★



**GROUND ANCHOR ATTACHMENT**



**\* WHEEL KIT CAN BE ADDED**



**ROUND DESIGN SHOWING NET CLIP TRACK**

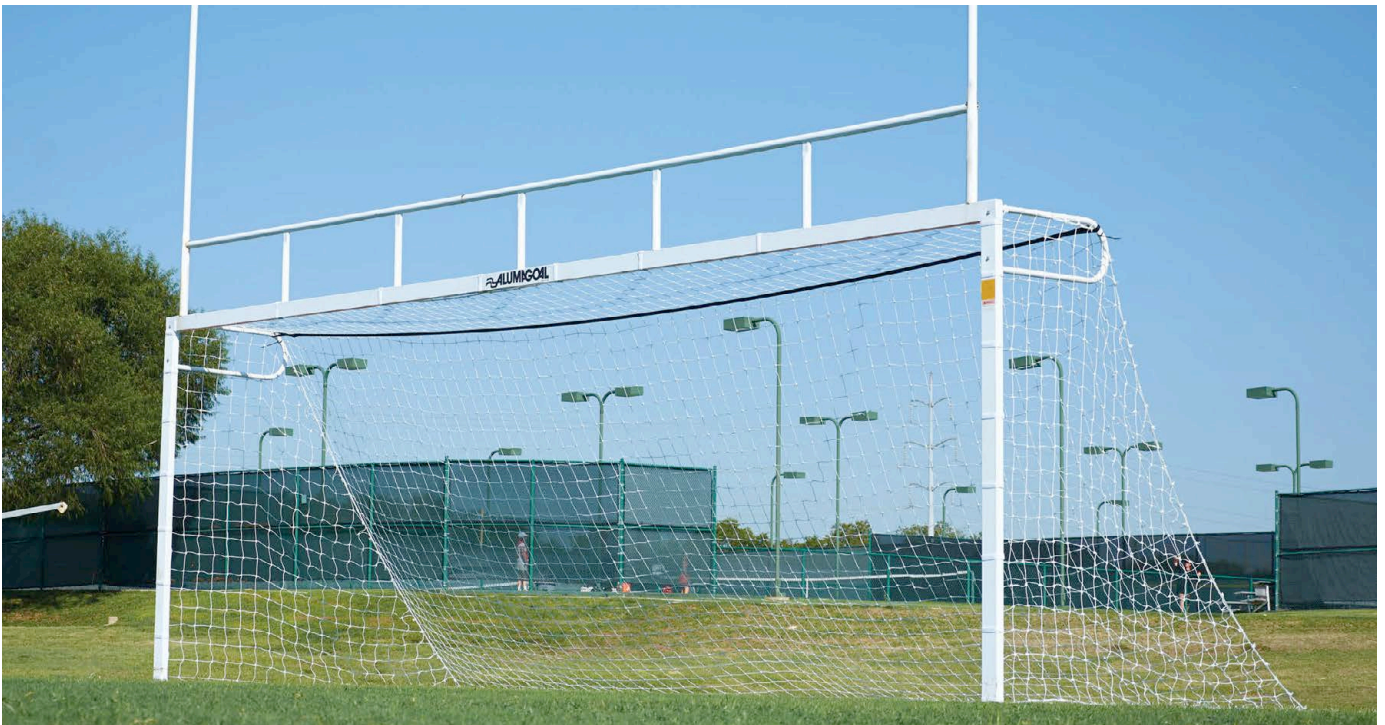

**FOOTBALL/SOCCER COMBO GOAL**

- Meets High School soccer and football regulations
- 10'H football uprights are constructed of 2" square aluminum tubing
- Width of uprights can be adjusted for H.S. (23'4") or Collegiate (18'6") play or removed for soccer play
- Soccer post are constructed of 11 gauge 2" x 4" steel tubing
- Crossbars are constructed of 14 gauge 2" x 4" steel tubing
- Two-piece engineered crossbar for increased ease of shipping and installation
- Euro style backstays are constructed of 14 gauge - 1.5" steel tubing

- Extremely corrosion resistant galvanized and white powder coated finish
- Goals include backstays, 4mm soccer nets, net fasteners and ground stakes
- Optional Ground Sleeves available for semi-permanent installation

**Lifetime Warranty**

<b>SGFBCOM</b>	1 Pair of Goals - Includes Nets	\$2,899 <sup>22</sup> PR ★
<b>I367769</b>	4mm - Replacement Net	\$249 <sup>22</sup> PR ★
<b>I308082</b>	Ground Sleeves - 4/Set	\$159 <sup>22</sup> SET ★



NATURAL ALUMINUM



FREE NETS &amp; GROUND ANCHORS INCLUDED

## ALUMIGOAL® 3" ROUND CLASSIC CLUB GOALS

- Front face is 3" round custom aluminum extrusion
  - Available in White (Powder Coated) or Natural Aluminum
  - Built in net clip track
  - Backstays are 2" round heavy wall aluminum tubing
  - Double reinforced Tig welded corners
  - Stainless steel hardware
  - Includes 4mm White Net, Net Clips and Ground Anchors
  - Includes Back Bottom Bar (24', 21', 18.5' & 12' models only)
  - Meets NFSHSA specs (8' x 24' SGA300 model only)
- 5 Year Limited Warranty**



**HEAVY WALL BOTTOM BAR  
ON 12', 18.5', 21' AND 24' MODELS**



**NET CLIP TRACK IN  
TOP AND SIDE FRAMES**



**NET CLIPS INCLUDED  
FAST SETUP & TAKEDOWN**

### NATURAL ALUMINUM 3" ROUND CLUB GOALS

<b>SGA320</b>	8'H x 24'W x 3'D x 8.5'B – 330 lbs./pr.	\$2,099 <sup>22</sup> PR ★
<b>SGA321</b>	7'H x 21'W x 3'D x 7.5'B – 301 lbs./pr.	\$1,999 <sup>22</sup> PR ★
<b>SGA322</b>	6.5'H x 18.5'W x 2'D x 7'B – 260 lbs./pr.	\$1,799 <sup>22</sup> PR ★
<b>SGA323</b>	6.5'H x 12'W x 2'D x 7'B – 208 lbs./pr.	\$1,599 <sup>22</sup> PR ★
<b>SGA324</b>	4.5'H x 9'W x 2'D x 4.5'B – 134 lbs./pr.	\$1,299 <sup>22</sup> PR ★
<b>SGA325</b>	4'H x 6'W x 2'D x 4'B – 118 lbs./pr.	\$1,199 <sup>22</sup> PR ★



### SOCCER GOAL SAFETY PADDING

- Meets NFSHSA rule regarding safety padding
- Fits 2" x 4", 4" x 4" and 3" & 4" round soccer goals
- High density 1" thick foam covered in white vinyl coated nylon
- Hook & loop fasteners attached
- 1 pair per goal

1089363

72"H

\$299<sup>22</sup> PR



**5**  
YEAR  
LIMITED WARRANTY

WHITE POWDER-COATED

FREE NETS & GROUND ANCHORS INCLUDED

## ALUMIGOAL<sup>®</sup> 3" ROUND CLASSIC CLUB GOALS

- Front face is 3" round custom aluminum extrusion
- Available in White (Powder Coated) or Natural Aluminum
- Built in net clip track
- Backstays are 2" round heavy wall aluminum tubing
- Double reinforced Tig welded corners
- Stainless steel hardware
- Includes 4mm White Net, Net Clips and Ground Anchors
- Includes Back Bottom Bar (24', 21', 18.5' & 12' models only)
- Meets NFSHSA specs (8' x 24' SGA300 model only)

5 Year Limited Warranty



### POWDER-COATED WHITE 3" ROUND CLUB GOALS

<b>SGA300</b>	8'H x 24'W x 3'D x 8.5'B – 330 lbs./pr.	\$2,299 <sup>22</sup> PR ★
<b>SGA301</b>	7'H x 21'W x 3'D x 7.5'B – 301 lbs./pr.	\$2,199 <sup>22</sup> PR ★
<b>SGA302</b>	6.5'H x 18.5'W x 2'D x 7'B – 260 lbs./pr.	\$1,999 <sup>22</sup> PR ★
<b>SGA303</b>	6.5'H x 12'W x 2'D x 7'B – 208 lbs./pr.	\$1,799 <sup>22</sup> PR ★
<b>SGA304</b>	4.5'H x 9'W x 2'D x 4.5'B – 134 lbs./pr.	\$1,499 <sup>22</sup> PR ★
<b>SGA305</b>	4'H x 6'W x 2'D x 4'B – 118 lbs./pr.	\$1,399 <sup>22</sup> PR ★



HEAVY WALL BOTTOM BAR  
ON 12', 18.5', 21' AND 24' MODELS

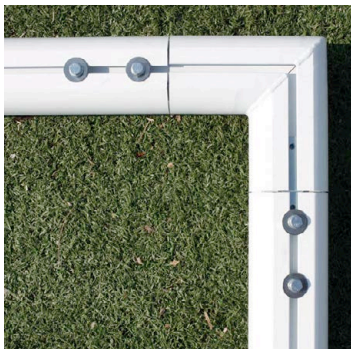

NET CLIP TRACK IN  
TOP AND SIDE FRAMES



NET CLIPS INCLUDED  
FAST SETUP & TAKEDOWN



**FREE NETS & GROUND ANCHORS INCLUDED**



## ALUMIGOAL<sup>®</sup> MANCHESTER MATCH GOAL

- Official size 8'H x 24'W x 3'D x 9'B
- Meets NCAA, NFSHSA and FIFA specs
- Crossbars and posts are 4" round, powder coated custom aluminum extrusion for superior strength
- Backstays are 2" round powder coated aluminum
- Double reinforced tig welded corners
- Built-in net clip track with clips
- Stainless steel hardware
- Includes 4mm Black/White hexagonal nets, 4 sand bags and transport wheels



**\$4,399<sup>99</sup>**

SGA402 ★ Complete Unit 

1397773 ★ Replacement Net **\$249<sup>99</sup>**



**NET CLIPS INCLUDED  
FAST SETUP & TAKEDOWN**



**ROUND DESIGN  
SHOWING NET CLIP TRACK**



**FEATURES:  
NET CLIP TRACK IN TOP,  
SIDE AND BOTTOM FRAMES**



**FLIP-OVER  
WHEELS  
FOR EASY  
TRANSPORT**



DESIGNED FOR FOOTBALL/  
SOCCER FIELDS

**ALUMAGOAL**

**4" EURO STADIUM ALUMAGOAL**

- Official size 8'H x 24'W x 3'D x 9'B
- Meets NCAA, NFSHSA and FIFA specs
- Crossbars and posts are 4" round, powder coated custom aluminum extrusion for superior strength
- European backstays are 2" round powder coated aluminum
- Double reinforced tig welded corners
- Built-in net clip track with clips
- Stainless steel hardware
- Includes 4mm Black/White, half depth hexagonal nets and sand bag anchors
- 380 lbs. Per Pair



**\$3,699<sup>99</sup>**

SGA403 ★ Complete Unit

136770 ★ Replacement Net **\$249<sup>99</sup>**



**ALUMAGOAL**

**4" EURO ALUMAGOAL**

- Official size 8'H x 24'W x 3'D x 9'B
- Meets NCAA, NFSHSA and FIFA specs
- Crossbars and posts are 4" round, powder coated custom aluminum extrusion for superior strength
- European backstays are 2" round powder coated aluminum
- Double reinforced tig welded corners
- Built-in net clip track with clips
- Stainless steel hardware
- Includes full depth 4mm white nets and sand bag anchors
- 386 lbs. Per Pair



**\$3,699<sup>99</sup>**

SGA401 ★ Complete Unit

136769 ★ Replacement Net **\$249<sup>99</sup>**



**Pro Premier® EUROPEAN MATCH GOAL**

- 4 3/8" round all aluminum, white powder coated construction
- Reinforced welded corners for strength and durability
- Kwik Lock® net system runs throughout goal for easy net attachment
- European style backstays
- Stainless steel hardware
- Includes: 3mm white nets, net support strap, net clips, (4) stationary no-flat wheels/tires or (4) removable swivel wheels/tires, (4) semi-permanent ground anchors and (6) saddle anchor bags
- Meets NCAA and NFSHSA specs
- 8'H x 24'W x 3'D x 9'B

**Lifetime Warranty**

1291162

With Stationary Wheels - 520 lbs/pr

\$6,699<sup>22</sup> PR



1379259

With Swivel Wheels - 570 lbs/pr

\$8,999<sup>22</sup> PR



**SWIVEL WHEELS**

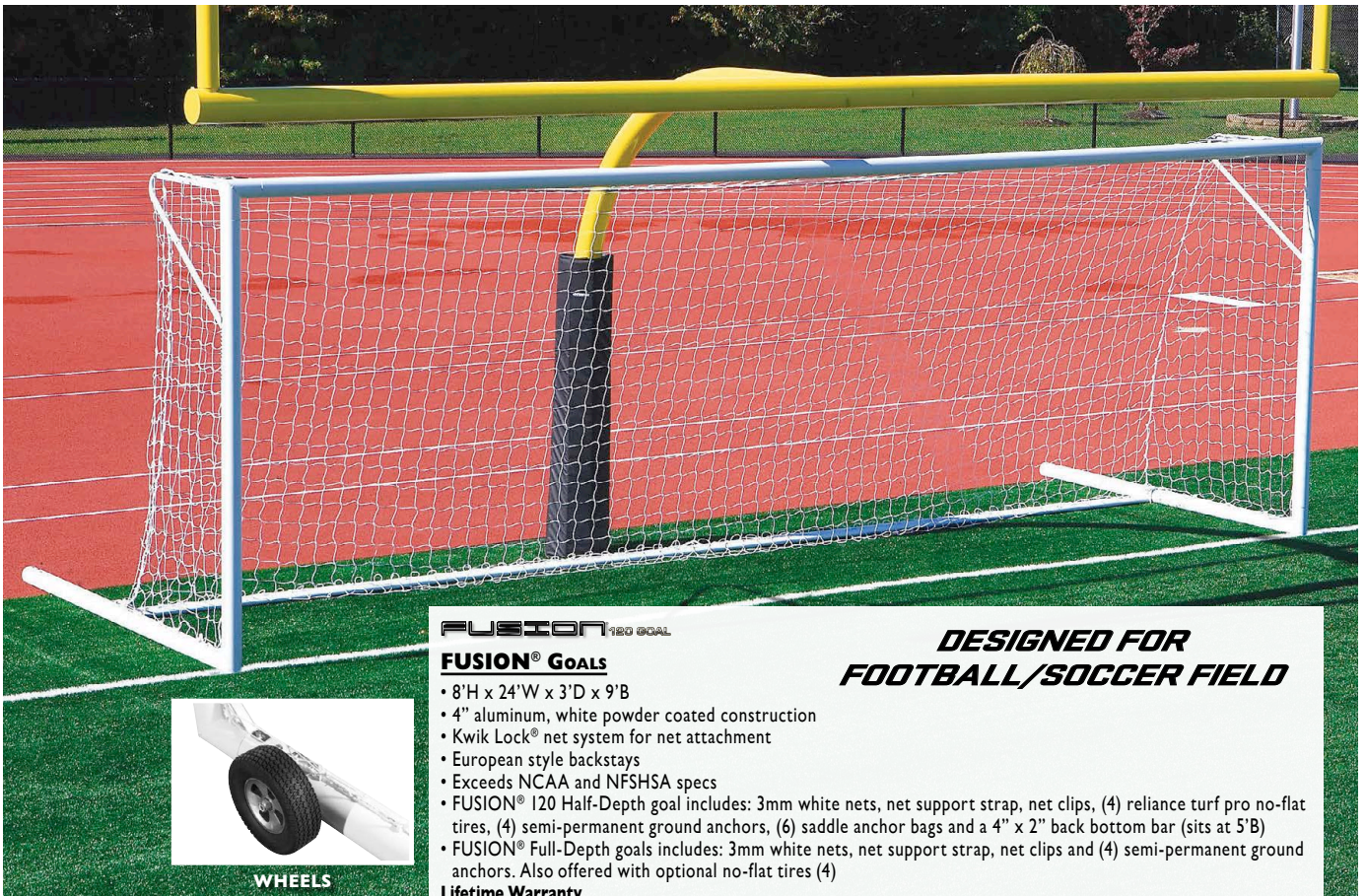

**FUSION<sup>®</sup> 120 GOAL**

**FUSION<sup>®</sup> GOALS**

- 8'H x 24'W x 3'D x 9'B
- 4" aluminum, white powder coated construction
- Kwik Lock® net system for net attachment
- European style backstays
- Exceeds NCAA and NFSHSA specs
- FUSION<sup>®</sup> 120 Half-Depth goal includes: 3mm white nets, net support strap, net clips, (4) reliance turf pro no-flat tires, (4) semi-permanent ground anchors, (6) saddle anchor bags and a 4" x 2" back bottom bar (sits at 5'B)
- FUSION<sup>®</sup> Full-Depth goals includes: 3mm white nets, net support strap, net clips and (4) semi-permanent ground anchors. Also offered with optional no-flat tires (4)

**Lifetime Warranty**

1291131

Fusion 120 Half-Depth Net w/Wheels - 550 lbs/pr

\$6,799<sup>22</sup> PR



1379271

Fusion Full Depth Net w/Wheels - 500 lbs/pr

\$6,199<sup>22</sup> PR



1379272

Fusion Full Depth Net w/o Wheels - 410 lbs/pr

\$5,299<sup>22</sup> PR



**WHEELS**

**DESIGNED FOR FOOTBALL/SOCCER FIELD**





WHEELS

**DELUXE EUROPEAN CLUB GOALS**

- 3" round all-aluminum construction
  - European style backstays
  - White powder coated finish
  - Kwik Lock® net system runs throughout goal for easy net attachment
  - Includes: 3mm white net, Kwik Lock net clips, net support strap, 4 semi-permanent ground anchors
- Lifetime Warranty**

I291070	8'H x 24'W x 3'D x 8.5'B - 280 lbs./pr	\$3,899 <sup>22</sup> PR	
I291087	7'H x 21'W x 3'D x 7.5'B - 254 lbs./pr	\$3,599 <sup>22</sup> PR	
I291094	6.5'H x 18.5' x 2'D x 7'B - 222 lbs./pr	\$3,399 <sup>22</sup> PR	
I291100	6.5'H x 12'W x 2'D x 7'B - 188 lbs./pr	\$2,999 <sup>22</sup> PR	
I291117	4.5'H x 9'W x 2'D x 5'B - 150 lbs./pr	\$2,599 <sup>22</sup> PR	
I291124	4'H x 6'W x 2'D x 4.5'B - 128 lbs./pr	\$2,199 <sup>22</sup> PR	
I379306	8'H x 24'W x 3'D x 8.5'B - w/Wheels	\$4,699 <sup>22</sup> PR	



**WHEEL OPTIONS**

- Reliance turf pro no-flat tires
- Wheel bracket rotates allowing goal to be lifted off ground and easily pushed

I291179	Fits Evolution Goals - Set of 4	\$549 <sup>22</sup> SET
I291186	Fits Euro Club Goals - Set of 4	\$549 <sup>22</sup> SET
I291193	Fits Match & Fusion Goals - Set of 4	\$549 <sup>22</sup> SET

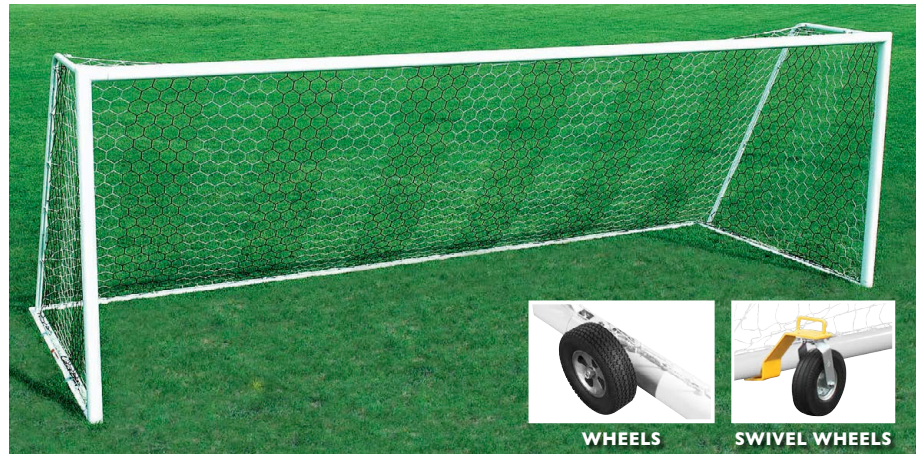

WHEELS

SWIVEL WHEELS

**EVOLUTION®**

**EVOLUTION® GOALS**

- **1.1 Goal** - 4" x 5" elliptical posts and crossbar, 4" x 2" elliptical base and back bottom bar, 2" round tube backdrop 4 3/8" round posts and crossbar
  - **2.1 Goal** - 4-3/8" round posts and cross bar, 4" x 2" elliptical base and back bottom bar, 2" round tube backdrop
  - All aluminum construction with White powder coated finish
  - Includes: 3mm Black/White hexagonal net, net support straps, Kwik Lock net clips, 4 semi-permanent ground anchors
  - Available with optional easy on/off swivel wheels for convenient transport
  - Meets NCAA and NFHS specs
  - 8'H x 24'W x 3'D x 9'B
- Lifetime Warranty**

I291148	1.1 Goal - 480 lbs/pr	\$6,199 <sup>22</sup> PR	
I388048	1.1 Goal w/Stationary Wheels - 560 lbs.pr	\$7,399 <sup>22</sup> PR	
I379257	1.1 Goal w/Swivel Wheels - 530 lbs/pr	\$9,299 <sup>22</sup> PR	
I291155	2.1 Goal - 510 lbs/pr	\$6,199 <sup>22</sup> PR	
I388049	2.1 Goal w/Stationary Wheels - 590 lbs/pr	\$7,399 <sup>22</sup> PR	
I379258	2.1 Goal w/Swivel Wheels - 560 lbs/pr	\$9,299 <sup>22</sup> PR	



**KWIK LOCK® NET CLIPS**

- Fits goals with Kwik Lock® and Evolution® net systems
- Set of 100 attaches 1 net to an 8' x 24' goal

I291209	Set of 50	\$52 <sup>22</sup> SET
I291216	Set of 100	\$83 <sup>22</sup> SET





**ELITE SHELTERS**

- 4" round powder coated all-aluminum outer frame
- Smoke-colored Lexan® polycarbonate panels
- Includes natural aluminum bench with back and storage shelf
- Comes with 4 semi-permanent ground anchors
- Available Shelter Frame and Bench Colors: White, Black, Red, Green, Yellow, Orange, Navy and Royal
- Please allow 2 - 4 weeks for delivery

**Lifetime Warranty**

1376947	6-1/2'H x 24'W x 5'D - 740 lbs	\$11,799 <sup>22</sup> EA	
1388059	6-1/2'H x 21'W x 5'D - 675 lbs	\$10,899 <sup>22</sup> EA	
1388058	6-1/2'H x 18'W x 5'D - 590 lbs	\$9,999 <sup>22</sup> EA	
1388057	6-1/2'H x 15'W x 5'D - 535 lbs	\$9,199 <sup>22</sup> EA	
1388056	6-1/2'H x 12'W x 5'D - 450 lbs	\$8,299 <sup>22</sup> EA	
1376948	6-1/2'H x 9'W x 5'D - 390 lbs	\$7,399 <sup>22</sup> EA	
1376951	Wheel Kit - Dolly & 4 Wheels	\$1,199 <sup>22</sup> EA	



**Elite Shelter Wheel Kit**



**NEW!**

**ELITE SHELTERS WITH WHEELS**

- 4" round powder coated all-aluminum outer frame
- Smoke-colored Lexan® polycarbonate panels
- Includes natural aluminum bench with back and storage shelf
- Comes with attached no-flat swivel wheels
- Available Shelter Frame and Bench Colors: White, Black, Red, Green, Yellow, Orange, Navy and Royal
- Please allow 2 - 4 weeks for delivery

**Lifetime Warranty**

1388610	6-1/2'H x 24'W x 5'D - 790 lbs	\$12,799 <sup>22</sup> EA	
1388611	6-1/2'H x 21'W x 5'D - 705 lbs	\$11,899 <sup>22</sup> EA	
1388612	6-1/2'H x 18'W x 5'D - 625 lbs	\$10,999 <sup>22</sup> EA	
1388613	6-1/2'H x 15'W x 5'D - 570 lbs	\$10,099 <sup>22</sup> EA	
1388614	6-1/2'H x 12'W x 5'D - 480 lbs	\$9,199 <sup>22</sup> EA	
1388615	6-1/2'H x 9'W x 5'D - 420 lbs	\$8,299 <sup>22</sup> EA	

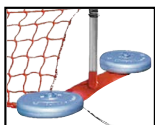

**COERVER TRAINING GOAL**

- Full-size 8'H x 24'W flat-faced goal
- Allows training on both sides of the goal simultaneously
- 1-3/4" round aluminum frame and Kwik Button® feature for quick assembly and break down
- Includes: Carry Bag and Net with medial and base shoe
- Available with outdoor steel anchoring shoes or all-surface shoes (weights incl.) for indoor use

**Lifetime Warranty**

1379264	Outdoor 8'H x 24'W	\$799 <sup>22</sup> EA
1379266	All-Surface 8'H x 24'W	\$1,059 <sup>22</sup> EA
1379265	All-Surface Conversion Kit	\$299 <sup>22</sup> EA
1379267	Replacement Net - Red	\$159 <sup>22</sup> EA
1379268	Replacement Net - White	\$159 <sup>22</sup> EA



**PORTABLE SHADE SHELTER**

- Powder coated all-aluminum frame
- 15'L x 10"W clear anodized aluminum bench with back
- 20"W clear anodized aluminum equipment shelf
- White colored Lexan® polycarbonate panels provide shade without limiting air flow
- Easily portable with 6 attached swivel wheels with flat proof tires
- Available Shelter Frame Colors: White, Black, Red, Green, Yellow, Orange, Navy and Royal
- Please allow 2 - 3 weeks for delivery

**Lifetime Warranty**

1376953	6-1/2'H x 15'W x 4-1/2'B x 6-1/2'D - 450 lbs each	\$6,299 <sup>22</sup> EA	
---------	---	--------------------------	--

**ALUMIGOAL**

**ALL PURPOSE BACKSTOP SYSTEM**

- Backstop system measures 21'H x 65'W
- Constructed with (4ea) 3.5" galvanized steel poles
- Choice of 3mm 4" mesh or 1.75" mesh (275 lb. breaking strength)
- Easy on and off pulley system and (4ea) galvanized steel ground sleeves
- Weight: 360 lbs.

<b>1071436</b>	System with 4" Netting	\$1,799 <sup>22</sup> EA ★	
<b>1071435</b>	System with 1 3/4" Netting	\$1,999 <sup>22</sup> EA ★	
<b>1249071</b>	Replacement Net - 4" Mesh	\$599 <sup>22</sup> EA ★	
<b>1072230</b>	Replacement Net - 1 3/4" Mesh	\$699 <sup>22</sup> EA ★	

**BALL BOUNDARY SYSTEM**

- Complete 12' high system with poles and netting
- Posts are constructed of 2 3/8"D x 3/16" wall aluminum tubing
- Ground Sleeves are aluminum with rubber caps
- Top and Bottom of Net is supported by nylon coated galvanized cable
- 1 3/4" 3mm braided knotless EHT black net
- Posts are spaced 20' apart
- Please allow 3 - 4 weeks for delivery

<b>BBS12A</b>	12'H System - Complete	\$26 <sup>22</sup> FT ★	
<b>BBSNET12</b>	12'H Replacement Net	\$8 <sup>22</sup> LF	



**SOCCER**



**OFFICIAL COMPETITION FUTSAL GOAL**

- 6'7"H x 9'10"W x 2'8"D x 3'4"B
- Full aluminum construction
- White powder coated goal face with built-in net clip track
- Includes free 4mm white net and non marring floor protectors

<b>1273472</b>	185 lbs./pr	\$1,499 <sup>22</sup> PR ★	
<b>1273489</b>	Replacement Net - 4mm	\$149 <sup>22</sup> PR ★	



**FREE CARRY BAG**

**ALUMIGOAL CARRY GOAL**

- 8'H x 24"W goal, convenient carry bag, 4 ground stakes and one full size weather resistant net
- Constructed of 2" extra-strong aluminum tubing
- Fast break-down and convenient portability with a 3-piece front crossbar system
- Optional all-surface conversion shoes available. 2/pr required per goal
- Weight: 60 lbs.

<b>STSGPTBG</b>	Goal & Net	\$639 <sup>22</sup> EA ★	
<b>1366835</b>	Optional All Surface Shoe	\$149 <sup>22</sup> PR ★	



**PORTABLE/FOLDABLE INDOOR SOCCER GOAL**

- Goal measures 6.5'H x 12'W x 5'D
- 2" square steel powder coated face
- Both backstays fold inward for storage
- Non-marking floor pads are on each of the 4 contact points
- 3mm white net
- Weight: 174 lbs. per pair

<b>SCGOAL5A</b>	2 Goals with Nets	\$699 <sup>22</sup> PR ★	
<b>SCGOAL5B</b>	1 Goal with Net	\$399 <sup>22</sup> EA ★	
<b>SCNET5</b>	Replacement Net	\$159 <sup>22</sup> EA ★	





**PUGG® SOCCER GOALS**

Safe and durable, these goals pop-up for instant use and fold into a 1" flat oval for easy storage. A favorite goal among soccer coaches for small-sided training, PUGG® goals also work well for floor hockey and field hockey training. Each pair includes storage bag and anchoring pegs.

**PUGG® Goal - 6'**

**1063936** 72" W x 42"H x 42"D - 7 lbs./pr **\$149<sup>99</sup>** PR

**PUGG® Goal - 4'**

**1063943** 48" W x 32"H x 32"D - 4 lbs./pr **\$109<sup>99</sup>** PR

**PUGG® Goal - 2.5'**

**1277180** 30" W x 24"H x 22"D - 3 lbs./pr **\$74<sup>99</sup>** SET



**Lil' SHOOTER 2 GOAL**

- Constructed of 1.312" O.D. galvanized steel tubing
- Includes 3mm 1.75" net with hook-and-loop fasteners
- Folds for easy portability and storage

**1248807** 4'H x 6'W x 2.5'D **\$299<sup>99</sup>** PR ★  
**1248814** Replacement Net **\$79<sup>99</sup>** PR ★



**Lil' SHOOTER GOAL**

- Made of 1.25" O.D. steel tubing with silver powder coated finish
- Includes 2mm nets with sewn in hook-and-loop fasteners
- Goal is foldable for easy portability to and from field

**1150872** 4'H x 6'W x 4'D **\$61<sup>99</sup>** EA ★  
**1150889** 5'H x 10'W x 5'D **\$84<sup>99</sup>** EA ★  
**1150896** Replacement Net 4' x 6' **\$23<sup>99</sup>** EA ★  
**1150902** Replacement Net 5' x 10' **\$29<sup>99</sup>** EA ★

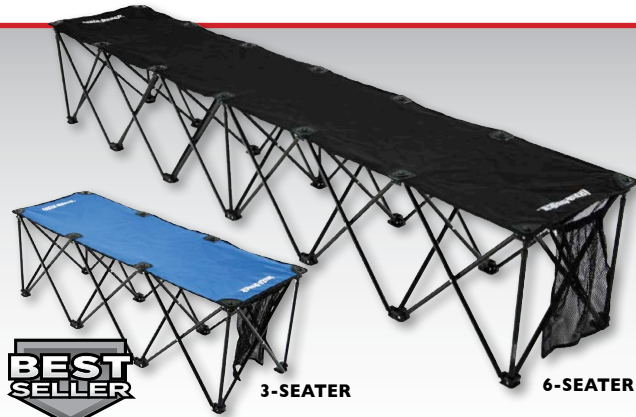

**INSTA-BENCH®**

- Insta-bench® is the original portable, collapsible bench
  - Made from high-density 600D polyester and comes with mesh pouch at one end of bench for storage
  - Takes only seconds to set up
  - Bench is rated to support up to 250 lbs. per seat
- Color Options: **Black, Royal, Scarlet.**

**1195941** 6-seater **\$94<sup>99</sup>** EA  
**1251876** 3-seater **\$59<sup>99</sup>** EA



**PORTABLE SOCCER GOAL**

- Rigid steel and fiberglass pole patented design
- No tools needed
- Assembles in minutes
- Tear resistant nylon netting
- Free carry case included

**1297461** 3'H x 5'W **\$109<sup>99</sup>** EA  
**1297478** 4'H x 8'W **\$189<sup>99</sup>** EA  
**1297485** 5'H x 10'W **\$299<sup>99</sup>** EA  
**1297492** 6'H x 12'W **\$329<sup>99</sup>** EA  
**1305746** 7'H x 14'W **\$369<sup>99</sup>** EA  
**1305753** 6.5'H x 18'W **\$419<sup>99</sup>** EA  
**1315899** 7'H x 21'W **\$599<sup>99</sup>** EA  
**1315882** 8'H x 24'W **\$699<sup>99</sup>** EA



## FUN FOR ALL AGES AND SKILL LEVELS

**FUNNETS™** are made of a unique blend of materials designed specifically for outdoor use. Our heavy body construction is UV treated and is unbreakable. We know you have seen the imitation PVC plastic goals which are made of tubing designed for plumbing applications. These imitation goals have a very low impact resistance which can cause the piping to break and expose sharp edges.

Our **5 Year Unlimited Warranty** is the best in the industry.  
**DON'T BE FOOLED BY CHEAP IMITATIONS!**

### SPORTSTUFF® ROD

Our engineers searched for the perfect blend of flex/strength ratio. The result was the Sportstuff® rod. A safe, unbreakable rod with UV stabilizers, that lasts a lifetime!



### FUNNETS® FITTINGS

The Funnet® fitting is molded out of ABS plastic with UV stabilizer for long life and strength. The fittings are longer for a more secure fit. Each fitting has set screws which allow the fitting to be tightened securely to the rod.

**EASY TO CARRY AND TRANSPORT**



### FUNNET® GOAL 7'H x 10'W x 5'D (ALUMINUM)

- 1.9" O.D. tubular aluminum
- Goal will not rust
- Comes complete with 3mm blue net

<b>FS710A</b>	Goal w/Net - 1 Each	\$359 <sup>99</sup> EA ★	
<b>1162356</b>	Replacement Net - 3mm, Blue	\$49 <sup>99</sup> EA ★	

### FUNNET® GOALS

- 1 5/8" O.D. heavy duty rods and indestructible ABS fittings
- Comes complete with 3mm blue net

#### 1. 3'H x 4'W x 1.5'D

<b>1150056</b>	Goal w/Net - 1 Each	\$119 <sup>99</sup> EA ★
<b>1150063</b>	Goals w/Nets - Pair	\$204 <sup>99</sup> PR ★
<b>1150070</b>	Replacement Net - 3mm, Blue	\$19 <sup>99</sup> EA ★

#### 2. 4'H x 6'W x 2'D

<b>1150025</b>	Goal w/Net - 1 Each	\$144 <sup>99</sup> EA ★
<b>1150032</b>	Goals w/Nets - Pair	\$244 <sup>99</sup> PR ★
<b>1150049</b>	Replacement Net - 3mm, Blue	\$27 <sup>99</sup> EA ★

#### 3. 6'H x 8'W x 3'D

<b>1149982</b>	Goal w/Net - 1 Each	\$179 <sup>99</sup> EA ★
<b>1149999</b>	Goals w/Nets - Pair	\$309 <sup>99</sup> PR ★
<b>1150018</b>	Replacement Net - 3mm, Blue	\$42 <sup>99</sup> EA ★

#### 4. 7'H x 10'W x 5'D

<b>FS710</b>	Goal w/Net - 1 Each	\$239 <sup>99</sup> EA ★	
<b>1162356</b>	Replacement Net - 3mm, Blue	\$49 <sup>99</sup> EA ★	



**J-Goal**

- Completely portable soccer goals
- Telescoping support poles, pre-attached net and quick connect cords
- Converts to high or low soccer tennis
- Includes carry bag and ground spikes

1366511	8'H x 24'W - 14 lbs.	\$219 <sup>92</sup> EA
1366516	7'H x 21'W - 12 lbs.	\$209 <sup>92</sup> EA
1366517	6'H x 18'W - 12 lbs.	\$199 <sup>92</sup> EA
1366527	6'H x 12'W - 12 lbs.	\$189 <sup>92</sup> EA



**TRAINER / REBOUNDER GOAL**

- Net can be adjusted for rebound, used for shooting skills, finishing skills or splitting one field into two
- Made of 1 7/8" diameter heavy wall aluminum tubing
- Spring button assembly requires no tools
- 30" steel anchoring shoes with permanent spikes
- 3mm 4" polyethylene net and carrying bag

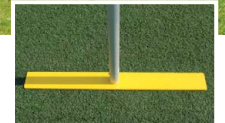

<b>1150858</b>	7'H x 21'W	\$569 <sup>92</sup> EA ★ <b>SAH</b>
<b>1076127</b>	Replacement Net	\$79 <sup>92</sup> EA ★
<b>1366835</b>	Optional All Surface Shoe	\$149 <sup>92</sup> PR ★

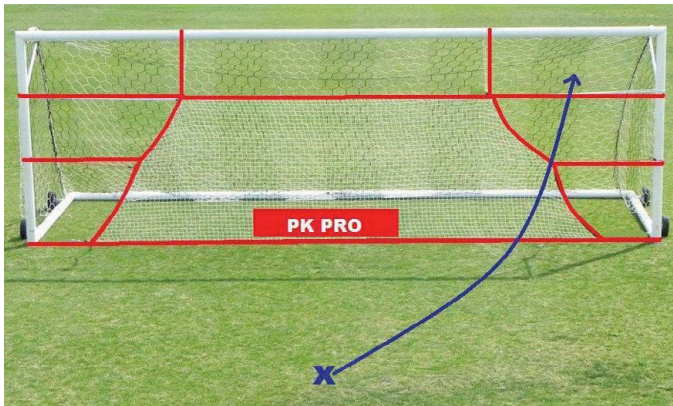

**PK PRO - SNIPERS NET**

- Fits full size 8'H x 24'W goal
- Replace your goalkeeper in drills and scrimmages
- Use for any finishing drill or rebound training
- Includes net, bungee straps and carry bag

1366518	\$149 <sup>92</sup> EA
---------	------------------------



**SOCCER WALL™ MAN**

- Includes (4) Collapsing Soccer Wall Mannequins
- Lightweight and wind resistant
- Body design deflects balls keeping the Mannequin upright
- PVC Pole clicks on and off and flex's when hit
- Ground spike version includes Flex Spring Base, Carry Bag, Drill Sheet and Soccer Tennis Conversion Net
- Weighted base version includes Field Turf Base that can be filled with sand or water for added weight (carry bag and tennis conversion net not included)



1306286	Set of 4 w/Weighted Base and Wheels	\$499 <sup>92</sup> SET ★
1306279	Set of 4 w/Ground Spikes	\$429 <sup>92</sup> SET ★



**NEW NEON COLORS!**

**LIGHTWEIGHT SCRIMMAGE VESTS**

- Polyester mesh vest
  - Reinforced neck and armholes
  - Elastic waistband
- Color Options: **Black, Gold, Kelly, Neon Green, Neon Orange, Neon Yellow, Orange, Purple, Royal, Scarlet.**

<b>C46Y</b>	K thru 3rd Grade	\$4 <sup>92</sup> EA ★
<b>C46</b>	4th-6th Grade, Middle School & Up	\$5 <sup>92</sup> EA ★
<b>C47N</b>	Adult (# 1-12) GO,KE,OR,PU,RO,SC,BK only	\$76 <sup>92</sup> DZN ★



**REVERSIBLE SCRIMMAGE VESTS**

- Polyester mesh construction
  - Reversible jerseys with elastic bottom
- Color Options: **Dark Green/Gold, Orange/Gold, Red/Black, Royal/Gold, Royal/Red, Silver/Black.**

<b>1262711</b>	Adult	\$77 <sup>92</sup> DZN ★
<b>1262773</b>	Youth	\$77 <sup>92</sup> DZN ★



**SELECT CAPTAIN'S ARM BAND**

- Velcro closure and extra elastic to keep in position on the arm
- Color Options: **Black, Blue, Orange, Pink, White, Green.**

1371625	Specify Color	\$4 <sup>92</sup> EA
---------	---------------	----------------------



**ALUMINGOAL<sup>®</sup>**  
**FLEXIBLE CORNER FLAGS**

- One piece construction
- 1/2" flexible PVC upright
- Steel spring base with ground stake
- 4 Flags/Set

**MSSOCFLGY** 60"H \$59<sup>22</sup> SET ★



Easily folds for storage

**FIBERGLASS CORNER FLAGS**

- Extra durable and light weight
- Two piece pole
- 4 Flags/Set

**20012999** 60"H \$39<sup>22</sup> SET ★

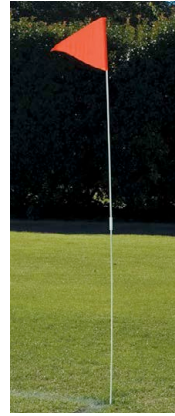

**LOW PROFILE CONES**

- Soft, flexible and stack easily
- Color code your drills for more effective practice time
- Available in Orange, Yellow or Prism Packs (2 each: Blue, Green, Orange, Purple, Red and Yellow)
- 3"H x 7 3/4" diameter

**1255706** Orange \$12<sup>22</sup> DZN ★  
**1276558** Yellow \$12<sup>22</sup> DZN ★  
**1255690** Prism Pack \$12<sup>22</sup> DZN ★



**WIRE CARRIER FOR LOW PROFILE CONES**

- Holds up to 60 low-profile field cones (cones not included)
- Easy carry and storage

**93095XXX** \$4<sup>22</sup> EA ★



**SEGMENTED CORNER FLAGS**

- 4-section 1" PVC material
- Bottom section is inserted and glued to the spring
- All 4-sections are connected by an interior 3mm cord, so pieces are not lost when disconnected
- 4 Flags/Set - Carry bag included

**1238624** 72"H \$82<sup>22</sup> SET ★



**INDOOR/OUTDOOR CORNER FLAGS**

- Can be used on turf surfaces
- Uses a spring loaded dome base
- Base must be filled with sand
- 4 Flags/Set

**1251838** 60"H \$69<sup>22</sup> SET ★

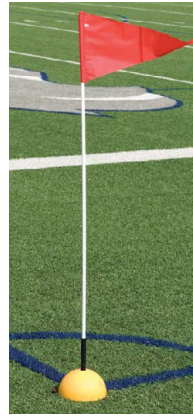

**ECONOMY CONES**

- Lightweight vinyl with small base
- No hole in top

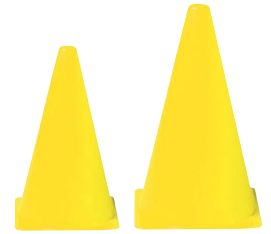

**MSCONE9XY** 9" \$2<sup>22</sup> EA ★  
**MSI2CONEY** 12" \$3<sup>22</sup> EA ★



**REFLEX SOCCER CORNER FLAGS**

- Reflex corner flag
- 1-Piece 1.33" O.D. PVC poles
- High visibility orange flags
- Includes: 4 flags with ground sockets & plugs and installation accessory kit. Storage bag not included

**MK4RFGSP** 66"H \$145<sup>22</sup> SET

- Includes: 6 flags with ground sockets & plugs and installation accessory kit. Storage bag not included.

**MK6RFGSP** 66"H \$189<sup>22</sup> SET

- Includes: 4 flags and storage bag. Ground sockets not included.

**MK4FB** 66"H \$129<sup>22</sup> SET

**MKA101** Ground Socket with Plug \$8<sup>22</sup> EA



**SPRING LOADED SOCCER CORNER FLAGS**

- Spring loaded corner flags that "give" when contacted by a player and return upright automatically
- 2-Piece 1.33" O.D. PVC poles
- High visibility orange flags

- Includes: 4 flags with ground sockets with plugs, installation accessory kit and storage bag.

**MK4X4S** 60"H \$169<sup>22</sup> SET

- Includes: 6 flags with ground sockets with plugs, installation accessory kit and storage bag.

**MK6X6S** 60"H \$229<sup>22</sup> SET

- Includes: 6 flags and storage bag. Ground sockets not included.

**MK6FB** 60"H \$169<sup>22</sup> SET

**MKA101** Ground Socket with Plug \$8<sup>22</sup> EA



**ORANGE GAME CONES**

- Flexible PVC with weighted base for added stability
- Stack easily for storage

**1040814** 12" \$8<sup>22</sup> EA ★  
**1040838** 18" \$10<sup>22</sup> EA ★  
**1040845** 28" \$29<sup>22</sup> EA  
**1040852SET** 36" \$209<sup>22</sup> SET OF 5

**LARGE PROFILE CONES**

- Soft-style - flexible and stackable
- Mix with low profile cones for various drills
- Approximately 6"H x 11" diam.

**1273687** Orange \$15<sup>22</sup> DZN ★  
**1336511** Yellow \$15<sup>22</sup> DZN ★



**CORNER FLAG CARRY BAG**

- Carries corner flags or coaching sticks
- Black Only

**1366514** 70"L x 7"W \$14<sup>22</sup> EA ★



**MacGregor**

**PLASTIC SHIN GUARDS**

- Practical shin guards with plastic foam backing

**MCSG7WHS** Youth - 7" \$3<sup>99</sup> PR ★  
**MCSG9WHS** Adult - 9" \$4<sup>99</sup> PR ★



**MacGregor**

**PADED SHIN GUARDS**

- Stirrup design for ankle and shin protection
- Adjustable hook/loop strap

**I276534** Youth - 7" \$15<sup>99</sup> PR ★  
**I276541** Adult - 9" \$15<sup>99</sup> PR ★



**MacGregor**

**ADULT PADDED SHIN GUARDS**

- Cloth guard with padded ankle, stirrup and three plastic inserts
- Machine washable

**MSSOCSHN** \$10<sup>99</sup> PR ★



**NEW!**



**BRINE KING FLEX G3 SHIN GUARDS**

- Moisture management backing
- Remoldable construction
- Free pair of pocket compression sleeves
- Adult - 7.5"
- Meets NOCSAE standards

**I388079** Black/Red \$20<sup>99</sup> PR



**MacGregor GOALIE GLOVES**

- White latex foam palm for grip and durability
- Gusseted fingers for comfort and ball control
- Hook-and-loop closure

**MCSGLVY** Youth: 4-6 \$24<sup>99</sup> PR ★  
**MCSGLVA** Adult: 7-10 \$25<sup>99</sup> PR ★



**NEW!**

**BRINE KING MATCH 3X GOALIE GLOVES**

- Backbone finger-protection technology prevents hyperextension and offers flexibility and comfort
- Mesh between fingers increases breathability
- Superior super-sticky latex foam for sure grip

**I388080** Specify Size 6 - 11 \$32<sup>99</sup> PR



**SELECT 33 GOALIE GLOVE**

- All weather practice and match glove
- Flexible and good fit
- Non-removable flexible finger spines
- SF/C2 white Dura Foam grip provides good grip and long life
- Wrist closure with hook and loop strap
- Flat cut

**I384350** Specify Size \$36<sup>99</sup> PR



**LINESMAN FLAGS**

- One red and one yellow 12" x 15" nylon flag
- 18" wood sticks with knob handles

**MSLFECN** \$9<sup>99</sup> PR ★

**REFEREE WATCH AND GAME TIMER**



- Countdown/Count up timer
- Dual Timing Display - Game time and Stoppage time
- 10 hour Dual Split with 1/100 second resolution
- Ten (10) Dual Split Memory recall stopwatch
- Time of Day in Hr, Min & Sec
- Day, Month and Date; Daily Alarm, Hourly Chime
- Water Resistant; Replaceable CR-2032 Battery

**I291841** \$39<sup>99</sup> EA



**SOCCER SCOREBOOK**

- 22 lines, 28 games
- Includes schedule and team roster

**MSSOCBOK** \$6<sup>99</sup> EA



**DOUBLE SIDED DRY-ERASE BOARD**

- 2 writing surfaces
- Includes pen & eraser with built-in storage pocket

**I240078** Soccer \$16<sup>99</sup> EA ★



**SPORT WRITE DRY-ERASE BOARDS**

- Large format enables entire team to see play
- 2 writing surfaces
- Great pen clip with premium dry erase marker

**I366485** 12 1/2"H x 16 1/2"W - 2 lbs. \$29<sup>99</sup> EA  
**I366486** 18"H x 23"W - 2.4 lbs. \$43<sup>99</sup> EA



**WARNING CARDS AND WALLET**

- Vinyl wallet holds one red and one yellow 3" x 4" plastic warning card
- Cards included

**MSREFWAL** \$4<sup>99</sup> EA ★





**FULL 90 PREMIER HEADGUARD**

- Advanced Trufit 2™ System
- Force Bloc™ Foam
- Ultralight Construction
- Ball Plays True off Head
- Extended Occipital Coverage
- Extended Temporal Impact Absorption
- Cool Max® Material
- Ponytail Port

Color Options: **Black, Navy, Red, Royal**  
Size: **S/M, LRG.**

1377011 Specify Color & Size \$44.99 EA



**EXO SHIELD HEADGUARD**

- Great for soccer and lacrosse protection plus more
- Reduces the effect of G-forces by over 50%
- Provides superior impact absorption, temperature control, breathability and comfort
- Lightweight open-cell viscoelastic foam used in combat-grade military helmet liners
- Black only
- Head Circumference in inches: Sz. 1 (20 - 20.5); Sz. 2 (20.5 - 21); Sz. 3 (21 - 21.5); Sz. 4 (21.5 - 22); Sz. 5 (22 - 22.5); Sz. 6 (22.5 - 23)

Size: **1, 2, 3, 4, 5, 6.**

1388100 Specify Size \$59.99 EA



**TEAM ROLLER BAG**

- 600 denier polyester shell
- Concealed pull handle
- Padded shoulder strap
- In-line wheel kit
- Oversized accessory pockets on both ends

Color Options: **Black, Royal, Scarlet.**

1385400 38"L x 16"W x 15"H \$67.99 EA ★



**TEAM DUFFLE BAG**

- Zip close compartments on both ends
- Double handle carry straps
- Padded shoulder harness
- Denier nylon with breathable air vents

Color Options: **Black, Royal, Scarlet.**

1377672 27"L x 14"W x 12"H \$29.99 EA ★

1377675 24"L x 12"W x 10"H \$24.99 EA ★



**LARGE DUFFLE EQUIPMENT BAG**

- Durable 600 denier polyester bag with a thick web shoulder strap and handle
- Military style closure
- Black only

1385397 33"L x 18"W \$24.99 EA ★



**TEAM EQUIPMENT BAG**

- Heavy duty polyester equipment bag
- Rugged nylon zipper with wrap around handles
- Black only

1377678 33"L x 12"W x 15"H \$19.99 EA ★

**NET BALL CARRIER**

- Holds 8-12 volleyballs, soccer balls, basketballs, or footballs

SNBCIXXX White Only \$8.99 EA ★



**MESH BALL CARRIER**

- Comes with shoulder strap, vinyl bottom and mesh top fabric

1235654 22"H x 28"W \$32.99 EA ★



**SELECT MATCH DAY BAG W/ 4 NUMERO 10's**

- Features four padded compartments with zippered mesh panels to keep game day balls in top condition
- Includes zippered small item pockets, a card organization system, clear i.d. holder, padded, removable shoulder strap and Velcro carry handles

1348583 Bag + 4 "Numero 10" Balls \$149.99 EA

1348576 Bag only \$46.99 EA



BLACK BLUE GOLD KELLY GREEN ORANGE PURPLE RED

**HEAVY-DUTY MESH EQUIPMENT BAG**

- Great for carrying and identifying equipment
- 32" x 36" bag holds up to 12 balls
- Includes clipping drawstring for easy and secure closure

Color Options: **Black, Blue, Gold, Kelly, Orange, Purple, Red.**

SNBCNET 32" x 36" (Specify Color) \$10.99 EA ★

SNBCNETW 24" x 36" (White Only) \$7.99 EA ★



# GILL POLE VAULT LANDING SYSTEMS

## ATHLETICS

All Gill Pole Vault Landing Systems use high density foam which provides long pit life without a hard landing, solid vinyl casings for increased weatherability, and the highest quality hardware.

- G** Made in America
  - G** Meet OSHA Fall Arrest Standards
  - G** Phthalates Free
- G** 18oz Vinyl Coated Woven Polyester

### ESSENTIALS™ POLE VAULT LANDING SYSTEM

- Meets NFHS requirements
  - In place of standard top pad, the Essentials™ employs a skirted mesh top that holds the units together for a snug fit.
  - Color: Royal Blue only
- 5 Year Limited Warranty**

1273090	Size: 19'9" x 20'2" x 26"	\$11,599 <sup>22</sup> EA	
1273106	Weather Cover	\$1,399 <sup>22</sup> EA	

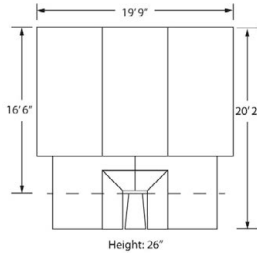

### GILL SCHOLASTIC I POLE VAULT LANDING SYSTEM

- Made of 18oz. vinyl-coated polyester fabric
  - Meets High School specifications
  - Includes 2" top pad
- 10 Year Limited Warranty**
- Color Options: **Black, Dk Green, Grey, Navy, Old Gold, Orange, Red, Royal, Yellow Gold, White.**



1375184	Size: 19'9" x 20'2" x 28"	\$14,699 <sup>22</sup> EA	
1375194	Weather Cover	\$1,799 <sup>22</sup> EA	

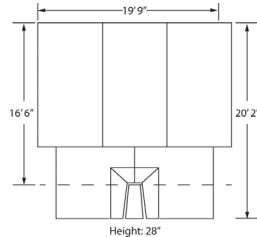

### SCHOLASTIC II POLE VAULT LANDING SYSTEM

- Made of 18oz. vinyl-coated polyester fabric
  - Meets High School specifications
  - Includes 2" top pad
- 10 Year Limited Warranty**
- Color Options: **Black, Dk Green, Grey, Navy, Old Gold, Orange, Red, Royal, Yellow Gold, White.**



1375206	Size: 21'6" x 23'5" x 28"	\$17,599 <sup>22</sup> EA	
1375216	Weather Cover	\$1,999 <sup>22</sup> EA	

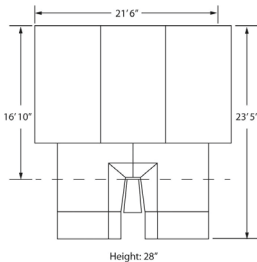

## GILL VALUE PACKS

### ESSENTIALS PACK

- 1375228**
- INCLUDES:**
- Essentials Landing System
  - Weather Cover
  - Base Pads
  - Essentials PV Standards
  - Essentials PV Crossbar

**\$14,199<sup>99</sup>**

### SCHOLASTIC I PACK

- 1375229**
- INCLUDES:**
- Scholastic I Landing System
  - Weather Cover
  - Base Pads
  - Scholastic PV Standards
  - Essentials PV Crossbar

**\$17,199<sup>99</sup>**

### SCHOLASTIC II PACK

- 1375230**
- INCLUDES:**
- Scholastic II Landing System
  - Weather Cover
  - Base Pads
  - Scholastic PV Standards
  - Essentials PV Crossbar

**\$19,899<sup>99</sup>**



**ALL LANDING SYSTEMS REQUIRE SAFETY MAX+ VAULT BOX INSERT (PG. 219)**

**TOP PAD COLORS**



**VINYL COLORS**



Scholastic, 20"W x 21"L x 28"H



Competition, 22"W x 22"L x 28"H (shown with Base Protector Pads)



### COMPETITION POLE VAULT LANDING SYSTEM

- Exceeds all High School specifications
- 22"W x 22"L, Pit has 16' 6"D of landing area behind the vault box
- Includes 2" top pad
- Includes 10' W x 8' D coaches box

#### OPTIONAL ITEMS

- Base Protector Pads (Required)

#### Landing Systems

GP2222X32	Size: 22"W x 22"L x 32"H	\$14,299 <sup>22</sup>	EA	★	
GP2222X28	Size: 22"W x 22"L x 28"H	\$13,699 <sup>22</sup>	EA	★	
GP2222X26	Size: 22"W x 22"L x 26"H	\$13,299 <sup>22</sup>	EA	★	

#### Weather Cover

GWC2222X32	32"	\$1,449 <sup>22</sup>	EA	★	
GWC2222X28	28"	\$1,349 <sup>22</sup>	EA	★	
GWC2222X26	26"	\$1,349 <sup>22</sup>	EA	★	

#### Base Protector Pads

STPADCNTL32	32"W x 130"L	\$2,499 <sup>22</sup>	PR	★	
STPADCNTL28	28"W x 130"L	\$2,399 <sup>22</sup>	PR	★	
STPADCNTL26	26"W x 130"L	\$2,399 <sup>22</sup>	PR	★	

### SCHOLASTIC POLE VAULT LANDING SYSTEM

- Exceeds High School NFHS specifications
- 20"W x 21"L, Pit has 16' 6" of landing area behind the vault box
- Includes 2" top pad
- Includes 10' W x 8' D Coaches Box
- Waffle system of deceleration

#### OPTIONAL ITEMS

- Base Protector Pads (Required)

#### Landing Systems

GP2021X28	Size: 20"W x 21"L x 28"H	\$11,899 <sup>22</sup>	EA	★	
GP2021X26	Size: 20"W x 21"L x 26"H	\$11,399 <sup>22</sup>	EA	★	

#### Weather Cover

GWC2021X28	28"	\$1,299 <sup>22</sup>	EA	★	
GWC2021X26	26"	\$1,249 <sup>22</sup>	EA	★	

#### Base Protector Pads

STPADCTR28	28"W x 107"L	\$1,699 <sup>22</sup>	PAA	★	
STPADCTR26	26"W x 107"L	\$1,649 <sup>22</sup>	PR	★	



**ALL LANDING SYSTEMS REQUIRE SAFETY MAX+ VAULT BOX INSERT (PG. 219)**



#### GRAPHICS FOR LANDING SYSTEMS

- Full color image of your mascot or your school name in the center of your top pad.
- Simply send camera-ready artwork along with your order and we will either mail or e-mail you a copy of the design for your signed approval.
- Please allow two to six weeks for delivery.

20028462 Maximum Size: 8' x 10' \$11<sup>22</sup> SQ.FT ★



### PORTaPit<sup>®</sup> PV VALUE PACK #1

#### INCLUDES:

- Landing System (GP2222X26)
- Base Protector Pads (STPADCNTL26)
- Weather Cover (GWC2222X26)
- Elite Standards (APVELITE)
- Vault Box Safety Mat (1376649)
- Premier Crossbars - Set of 3 (AFPVI503)

**\$15,999<sup>00</sup>**  
**SAVE OVER \$2,800**



### PORTaPit<sup>®</sup> PV VALUE PACK #2

#### INCLUDES:

- Landing System (GP2021X28)
- Base Protector Pads (STPADCTR28)
- Weather Cover (GWC2021X28)
- Vault Box Safety Mat (1376649)
- Competition Standards (AOVSXXXX)
- Premier Crossbars - Set of 3 (AFPVI503)

**\$14,490<sup>00</sup>**  
**SAVE OVER \$2,200**

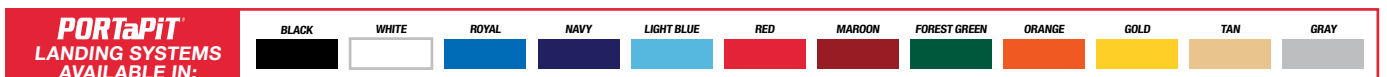

# GILL HIGH JUMP LANDING SYSTEMS

## ATHLETICS

All Gill High Jump Landing Systems use high density foam which provides long pit life without a hard landing, solid vinyl casings for increased weatherability, and the highest quality hardware.

- G** Made in America
  - G** Meet OSHA Fall Arrest Standards
  - G** Phthalates Free
- G** 18oz Vinyl Coated Woven Polyester

### ESSENTIALS HIGH JUMP LANDING SYSTEM

- Meets all high school rules requirements.
  - In place of standard top pad, the Essentials™ employs a skirted mesh top that holds the units together for a snug fit.
  - (2) Base units: 8' x 8' x 24"
  - Color: Royal blue only
- 5 Year Limited Warranty**

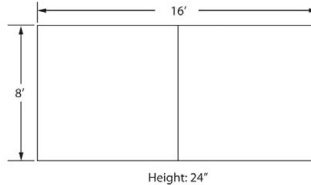

1273137	Size: 8' x 16' x 24"	\$4,199 <sup>22</sup> EA	<b>S&amp;H</b>
1273144	Weather Cover	\$699 <sup>22</sup> EA	<b>S&amp;H</b>



### SCHOLASTIC I HIGH JUMP LANDING SYSTEM

- Made of 18oz. vinyl-coated polyester fabric
  - Meets High School specifications
  - Includes 2" top pad
- 10 Year Limited Warranty**
- Color Options: **Black, Dk Green, Grey, Navy, Old Gold, Orange, Red, Royal, Yellow Gold, White.**

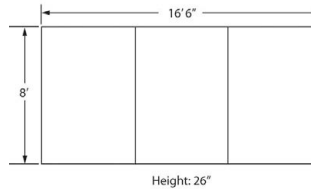

1371587	Size: 16'6" x 8' x 26"	\$5,899 <sup>22</sup> EA	<b>S&amp;H</b>
1371597	Weather Cover	\$899 <sup>22</sup> EA	<b>S&amp;H</b>



### SCHOLASTIC II HIGH JUMP LANDING SYSTEM

- Made of 18oz. vinyl-coated polyester fabric
  - Meets High School and NCAA specifications
  - Includes 2" top pad
- 10 Year Limited Warranty**
- Color Options: **Black, Dk Green, Grey, Maroon, Navy, Old Gold, Orange, Purple, Red, Royal, Yellow Gold, White.**

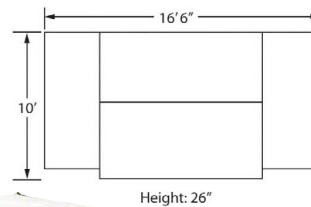

1375162	Size: 16'6" x 10' x 26"	\$7,499 <sup>22</sup> EA	<b>S&amp;H</b>
1375172	Weather Cover	\$1,099 <sup>22</sup> EA	<b>S&amp;H</b>



## GILL VALUE PACKS

Value packs from Gill Athletics are a great way to fully equip your school with quality Gill equipment and save money!

### ESSENTIALS PACK

1375231

**INCLUDES:**

- Essentials Landing System
- Weather Cover
- Essentials HJ Standards
- Essentials HJ Crossbar

**\$4,999<sup>99</sup>**

### SCHOLASTIC I PACK

1275132

**INCLUDES:**

- Scholastic I Landing System
- Weather Cover
- Scholastic HJ Standards
- Essentials HJ Crossbar

**\$6,999<sup>99</sup>**

### SCHOLASTIC II PACK

1275133

**INCLUDES:**

- Scholastic II Landing System
- Weather Cover
- Scholastic HJ Standards
- Essentials HJ Crossbar

**\$8,499<sup>99</sup>**

**TOP PAD COLORS**

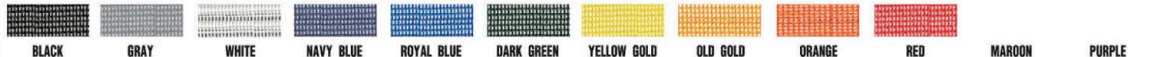

**VINYL COLORS**





CODE	OVERALL SIZE	3 BASE UNITS	TOP PAD	WEIGHT
GPI218X28	12' x 18' x 28"	6' x 12' x 26"	12' x 18' x 2"	750-LBS
GPI218X24	12' x 18' x 24"	6' x 12' x 22"	12' x 18' x 2"	680-LBS

CODE	OVERALL SIZE	3 BASE UNITS	TOP PAD	WEIGHT
GP0816X28	8' x 16'6" x 28"	5'6" x 8' x 26"	8' x 16'6" x 2"	550-LBS
GP0816X24	8' x 16'6" x 24"	5'6" x 8' x 22"	8' x 16'6" x 2"	450-LBS

**COMPETITION HIGH JUMP LANDING SYSTEM**

- Made of 18 oz. coated polyester fabric
- Meets all High School and NCAA specifications
- Includes 2" top pad
- 5 Year Limited Warranty**

GPI218X28	Size: 12' x 18' x 28"	\$7,299 <sup>00</sup> EA ★
GWC1218H	Weather Cover	\$729 <sup>00</sup> EA ★
GPI218X24	Size: 12' x 18' x 24"	\$6,499 <sup>00</sup> EA ★
GWC1218M	Weather Cover	\$729 <sup>00</sup> EA ★



+ Weather Cover

**PORTaPiT<sup>®</sup> HJ VALUE PACK #1**

**INCLUDES:**

- Landing System (GPI218X28)
- Weather Cover (GWC1218H)
- Elite Standards (AHJELITE)
- Premier Crossbars - Set of 3 (AFHJ1503)

**\$7,799<sup>00</sup>**  
**SAVE OVER \$1,000**

**SCHOLASTIC HIGH JUMP LANDING SYSTEM**

- Made of 18 oz. coated polyester fabric
- Meets all High School and NCAA specifications
- Includes 2" top pad
- 5 Year Limited Warranty**

GP0816X28	Size: 8' x 16'6" x 28"	\$4,799 <sup>00</sup> EA ★
GWC0816H	Weather Cover	\$499 <sup>00</sup> EA ★
GP0816X24	Size: 8' x 16'6" x 24"	\$4,399 <sup>00</sup> EA ★
GWC0816M	Weather Cover	\$499 <sup>00</sup> EA ★



+ Weather Cover

**PORTaPiT<sup>®</sup> HJ VALUE PACK #2**

**INCLUDES:**

- Landing System (GP0816X28)
- Weather Cover (GWC0816H)
- Competition Standards (ACJSXXXX)
- Premier Crossbars - Set of 3 (AFHJ1503)

**\$4,999<sup>00</sup>**  
**SAVE OVER \$950**

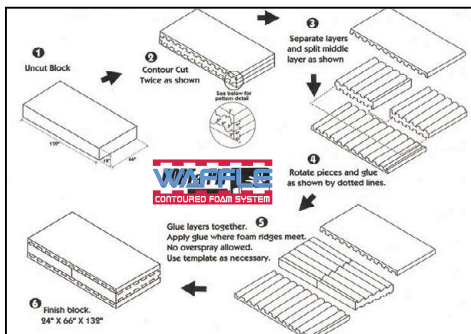
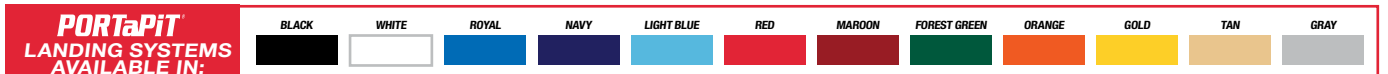

**Why PORTaPiT<sup>®</sup> is a Better Value**

ALL VAULTING PITS & HIGH JUMP PITS FEATURE THE REVOLUTIONARY WAFFLE DESIGN AND INCLUDE A 5-YEAR LIMITED WARRANTY!



**Heavy Duty Weather Cover**

## HIGH JUMP STANDARDS



**NEW!**

### PORTaPiT<sup>®</sup> COMPETITION

- Adjusts from 2'-8" marked with English/Metric scale
- Meets NFHS and NCAA specifications

1378658

\$449<sup>22</sup> PR ★

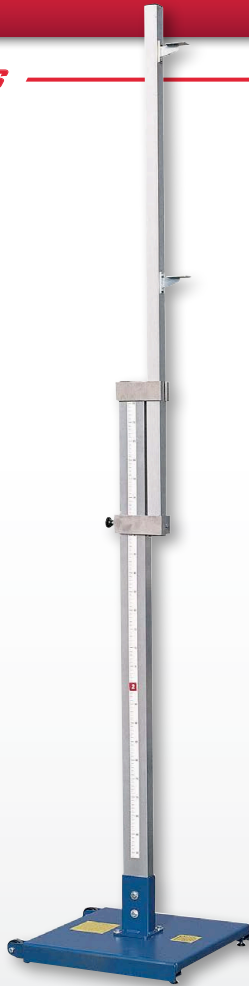

### PORTaPiT<sup>®</sup> ELITE

- Features: anodized aluminum uprights and steel bases with wheels for easy transport
- Levelers on each base insure accurate height adjustments
- Adjusts from 3' to 8.5'
- Marked in English and metric measurements
- Meets High School, NCAA<sup>®</sup> and IAAF specifications

AHJELITE

\$599<sup>22</sup> PR ★

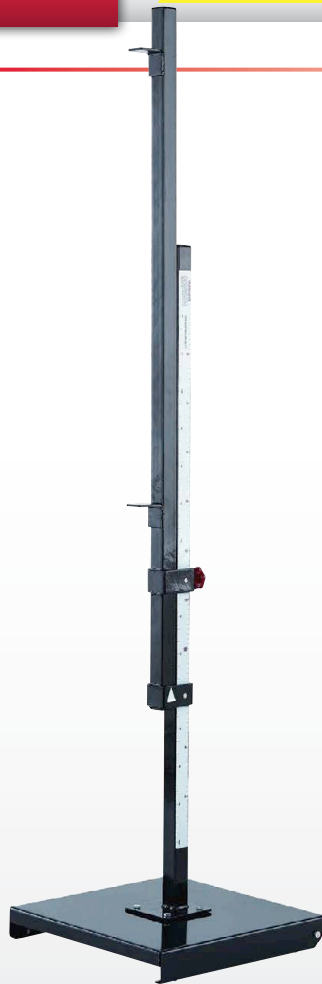

### GILL ATHLETICS ESSENTIALS

- All steel construction with black powder coat finish
- 18" square base with wheels
- Height scales read in English and Metric from 2' to 8'
- Meets High School and NCAA specifications

**10 Year Limited Warranty**

1375234

\$479<sup>22</sup> EA



### GILL ATHLETICS COLLEGIATE

- Made of heavy gauge steel which bolts to a 18" square roll away base
- Riser is aircraft aluminum with cast aluminum bar rest
- Adjusts from 2' to 8'
- Meets High School, NCAA<sup>®</sup> and IAAF specifications

1273182

\$949<sup>22</sup> PR



### GILL ATHLETICS WOOD DECK PIT CART

- Constructed of 3/4" MDO exterior plywood
- Cart deck measures 4' x 8'
- 12" pneumatic wheels for easy maneuverability
- Deck height is 16"

1273168

\$1,599<sup>22</sup> EA

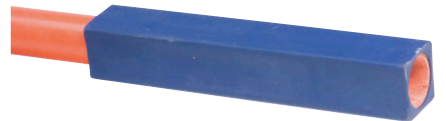

SHIPPING & HANDLING \$75.00 PER ORDER (up to 3 Crossbars)

### PORTaPiT<sup>®</sup> PREMIER HJ CROSSBAR

- Pole is 13' 1 1/2"
- Meets collegiate, international, and NFHS specification

AFHJ1500

\$65<sup>22</sup> EA ★

AFHJ1503

Set of 3

\$174<sup>22</sup> SET ★



MADE IN USA

### PORTaPiT<sup>®</sup> ELEMENTARY HIGH JUMP PIT

- Ideal for elementary physical education classes
  - Created and designed for the younger athlete
  - Meets our own rigorous safety standards
  - **This pit does not require a top pad**
- 5 Year Limited Warranty**

GBU24511

5'6" x 11' x 24"

\$2,349<sup>22</sup> EA ★

GBU30511

5'6" x 11' x 30"

\$2,749<sup>22</sup> EA ★

POLE VAULT STANDARDS



**GILL**  
ATHLETICS  
**ESSENTIALS**

- Full steel tubing construction
- Height adjustment from 6' to 16' reading both English and Metric
- Upright detaches from base rails for storage
- 75mm bar rest pins and 8 base anchors included
- Meets NFHS specification

10 Year Limited Warranty

1375235 \$1,249<sup>22</sup> EA



**GILL**  
ATHLETICS  
**ALUMINUM**

- All aluminum construction for superior resistance
- Wide stance base for improved stability
- Adjusts from 7' to 18'
- Marked for English and metric measurements
- Meets High School and NCAA specifications

1273175 \$1,999<sup>22</sup> PR

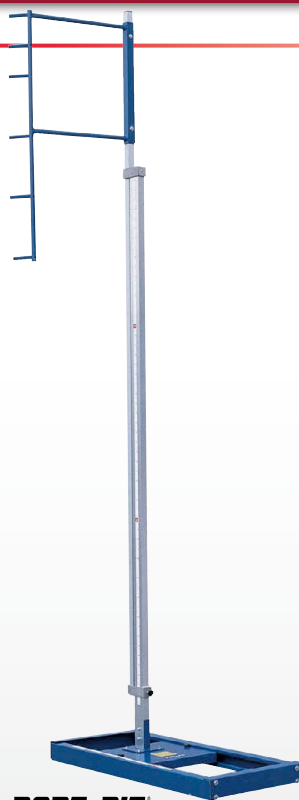

**PORTaPIT**  
**ELITE**

- Anodized aluminum uprights with steel bases
- Nylon rollers allow smooth 0-31.5" of front/back movement
- Adjusts from 8' to 21'
- Marked in both English and metric measurements
- Meets High School, NCAA® and IAAF specifications
- Use CenterSet Base Protector Pads

APVELITE \$1,299<sup>22</sup> PR ★



Easily Attaches to standards for extra 3' lower settings

**NEW!**  
**PORTaPIT**  
**COMPETITION**

- Steel uprights and base are finished with silver powder coat
- Base adjusts 0"-32" on easy glide polyurethane skate wheels
- Detachable upright adjusts from 7'-18' marked with English/Metric scale
- Equipped with 75mm bar rest pins (55mm pins sold separately)
- Meets NFHS and NCAA specifications

1378660 \$999<sup>22</sup> PR ★  
AFEXTEND \$99<sup>22</sup> PR ★  
1378679 55mm Bar Rest Pins (Set of 12) \$19<sup>22</sup> SET ★



**ELASTIC CROSSBAR**

- Elastic practice crossbar with black foam
- Fits both high jump and pole vault

AFR050BM \$29<sup>22</sup> EA



**GADGET BAR LIFTER**

- Ideal bar replacement tool
- Fits all regulation crossbars

1126310 \$26<sup>22</sup> EA ★

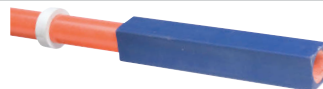

SHIPPING & HANDLING  
\$75.00 PER ORDER  
(up to 3 Crossbars)

**CATA-POLE** **PREMIER PV CROSSBAR**

- Pole is 14'10"L
- Meets Collegiate, International, and NFHS specifications
- Comes with Nofzinger feature

2 Year Limited Warranty  
AFPV1500 \$65<sup>22</sup> EA ★   
AFPV1503 Set of 3 \$174<sup>22</sup> SET OF 3 ★



**GILL**  
ATHLETICS  
**SAFETYMAX+ VAULT BOX INSERT**

- Provides additional protection by padding exposed hard surfaces
- Fully compliant with ASTM Standard F2949
- Safety yellow color helps highlight open area for planting and vaulting
- SafetyMax will work with any style of pole vault landing system

1376649 \$649<sup>22</sup> EA



**ALUMINUM VAULT BOX WITH LID**

- Rust-resistant 1/8" aluminum
- 105 degree angle on front
- Meets HS, Collegiate, and International standards

AALMVBOX \$569<sup>22</sup> EA



**STEEL VAULT BOX**

- 12 gauge steel construction
- 105 degree angle on front
- Meets HS, Collegiate, and International Standards

ASTLVBOX \$199<sup>22</sup> EA



**GILL**  
ATHLETICS  
**ALUMINUM VAULTING BOX**

- Welded aluminum construction
- Meets high school and NCAA specifications
- IAAF certified

1371586 \$499<sup>22</sup> EA

## STARTING BLOCKS

**GILL**  
 ATHLETICS  
**Fusion™ III**

- Features an angled spike in the base
- Built-in handle for easy carry
- Standard width pedals w/fixed angle of 60 degree

I273069

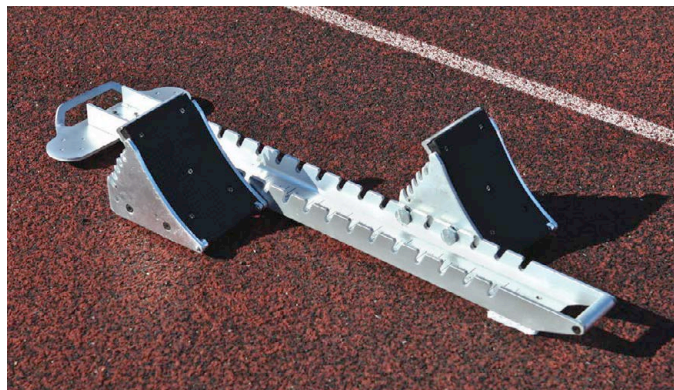
\$289<sup>99</sup> EA
**PORTaPiT™**  
**ULTIMATE**

- All aluminum construction
- 5-angle adjustable pedals
- IAAF certified and comes with 15mm spikes
- Easy to grab handle

ASB5000X

\$199<sup>99</sup> EA ★
**PORTaPiT™**  
**PREMIER**

- Cast aluminum, 4-angle wide adjustable pedals
- Durable polished aluminum chrome rail
- Block measures: 12.5"W x 33"L
- Complete with spike wrench and spikes

ASB4500X

\$179<sup>99</sup> EA ★
**PORTaPiT™**  
**ELITE**

- Cast aluminum, 4-angle wide adjustable pedals
- Durable steel rail
- Block measures: 12"W x 35"L
- Complete with spike wrench and spikes

ASB3500X

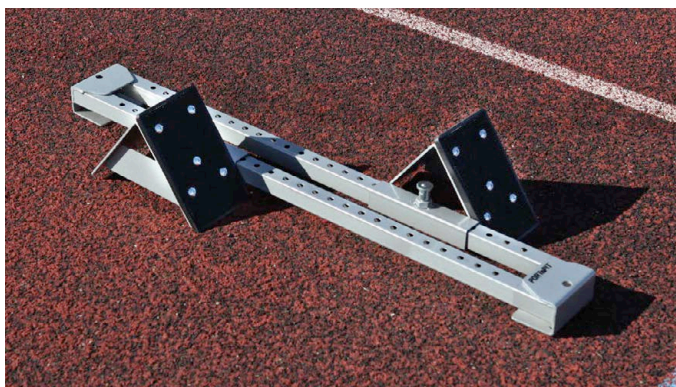
\$159<sup>99</sup> EA ★
**PORTaPiT™**  
**COMPETITION**

- All steel components
- Spring loaded plunger for pedal adjustment and secure locking
- Complete with spike wrench and spikes

ASB2000S

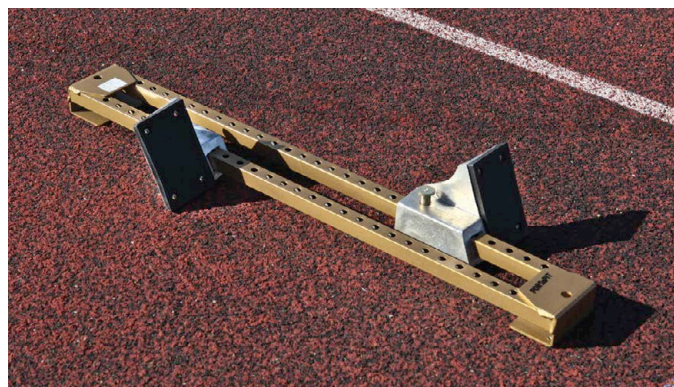
\$89<sup>99</sup> EA ★
**PORTaPiT™**  
**SCHOLASTIC**

- Steel double rail with cast pedals and plunger adjustment
- Great for middle and high school programs
- Complete with spike wrench and spikes

ASB1500X

\$79<sup>99</sup> EA ★





**RELAY BATONS**

- Lightweight anodized aluminum baton
  - Features smooth rolled-in edges and non-slip ground finish
  - Official size
- Color Options: **Green, Red, Blue, Gold, Silver, Black, Purple.**

<b>AALBAT</b>	Aluminum Baton	\$3 <sup>22</sup> EA ★
<b>APLBATONPK</b>	Yellow (plastic) - Pack of 6	\$7 <sup>22</sup> PACK OF 6 ★

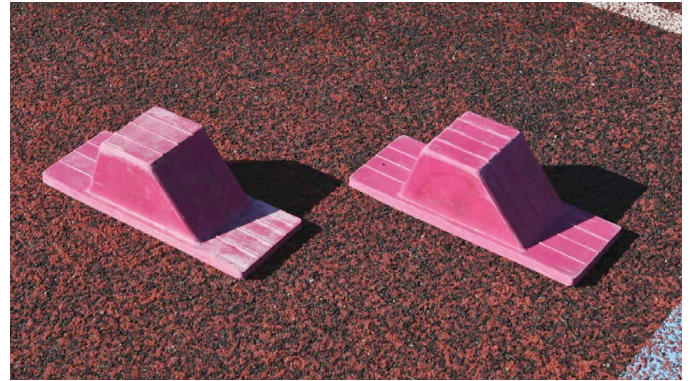

**PORTaPiT<sup>™</sup>  
INDOOR STARTING BLOCKS**

- Non-slip, poly-blocks make it easy to practice indoors during inclement weather
- Simply apply pressure to blocks with foot and blocks provide the athlete with non-slip starts indoors

<b>6036XXXX</b>	\$54 <sup>22</sup> PR ★
-----------------	-------------------------



**PYRAMID SPIKES**

1/8" BAG OF 100

<b>AASPKPI8</b>	1/8"	\$15 <sup>22</sup> PACK OF 100
<b>AASPKPI4</b>	1/4"	\$15 <sup>22</sup> PACK OF 100
<b>1098273</b>	3/16"	\$15 <sup>22</sup> PACK OF 100



**NEEDLE SPIKES**

1/8" Bag of 100

<b>AASPKNI8</b>	1/8"	\$15 <sup>22</sup> PACK OF 100
<b>AASPKNI4</b>	1/4"	\$15 <sup>22</sup> PACK OF 100
<b>1098280</b>	3/16"	\$15 <sup>22</sup> PACK OF 100



**SPIKE WRENCH**

<b>SHSPIKW</b>	\$6 <sup>22</sup> EA
----------------	----------------------



**TRACK SPIKE KIT**

- Spike Kit in a molded container with a 3-way key wrench
- Includes 1,500 spikes: (200) 1/8" pyramid, (400) 1/4" pyramid, (100) 3/8" pyramid, (100) 1/2" pyramid, (400) 1/4" needle, (200) 3/16" needle, (100) 3/8" needle

<b>1273427</b>	\$166 <sup>22</sup> EA
----------------	------------------------

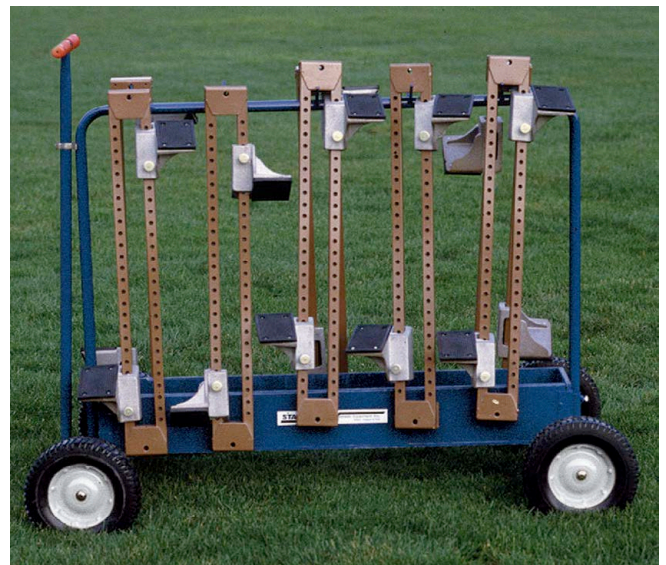

**STARTING BLOCK CART**

- All steel construction with quality blue enamel finish and easy rolling
- Holds 10 blocks and has storage for spikes and accessories.
- 10" x 2 3/4" wheels

<b>20010511</b>	\$339 <sup>22</sup> EA ★	
-----------------	--------------------------	--

## HURDLES



### ELITE HIGH SCHOOL

- The standard for elite high school track programs
- All aluminum square tube construction with welded cross support
- Meets official high school pullover requirements at 30", 33", 36", 39" and 42"
- Meets high school specifications
- Ships assembled

1371552

Specify Color

\$209<sup>22</sup> EA

**RISERS AVAILABLE IN:**



### HIGH SCHOOL

- Powder coated steel U-shaped single cross support design
- Weighted base and Lexan gateboard
- 41" hurdle adjustable to 30", 33", 36", 39" and 42"
- Meets high school specifications

1371569

Specify Color

\$179<sup>22</sup> EA



### PORTaPiT<sup>™</sup>

#### X-TRAINER

- Ideal hurdle for plyometrics, speed, and agility.
- Adjusts from 6" to 42"
- Inexpensive style for beginners to use
- Hurdle folds flat for easy transport and storage

1274509

\$54<sup>22</sup> EA ★

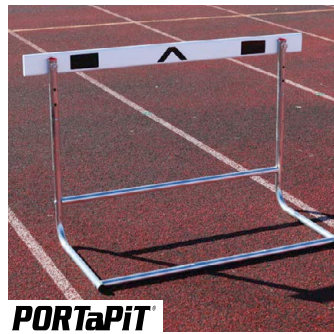

### PORTaPiT<sup>™</sup>

#### JUNIOR TRAINING

- Lightweight all anodized aluminum construction
- Includes PVC hurdle board and nylon breakaway gate with hook-and-loop grip
- Rocker design will automatically right itself
- Instant locking at 5 heights: 22", 24", 26", 28" and 30"
- Weight: 10 lbs.

AJEVXXXX  
AVELCROS

Nylon Breakaway Gates

\$64<sup>22</sup> EA ★

\$5<sup>22</sup> EA ★

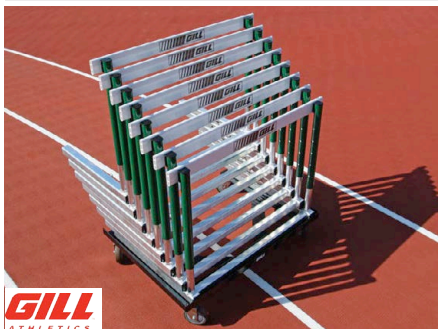

### FLIGHT HURDLE CART

- Sturdy steel construction with black powder coated finish
- Four wheel design provides superior moveability
- Designed for "L" shaped hurdles only
- Holds 8-10 hurdles

GA4630

\$249<sup>22</sup> EA ★



### 2-WHEEL HURDLE CART

- Steel construction with durable black powder coat finish
- Compatible with "L" shaped hurdles only
- Holds 8-10 hurdles

GA4210

\$299<sup>22</sup> EA ★

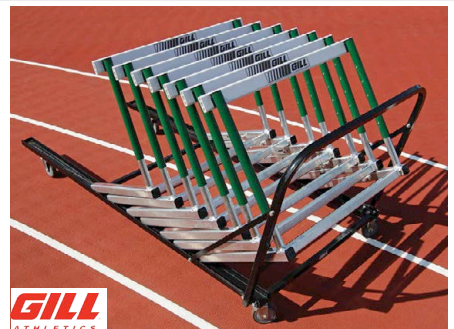

### HURDLE TRANSPORT CART

- Steel construction with durable black powder coated finish
- Large swivel casters for easy transportation
- Compatible with both rocker and "L" shaped hurdles
- Holds 15-20 hurdles

GA4020

\$599<sup>22</sup> EA ★

**PORTaPIT HURDLES** Height adjustments at 30", 33", 36", 39" and 42"

RISERS AVAILABLE IN:  BLACK  DK GREEN  GREY  KELLY  LT. BLUE  MAROON  NAVY  OLD GOLD  ORANGE  PURPLE  RED  ROYAL  SILVER  WHITE  YELLOW GOLD

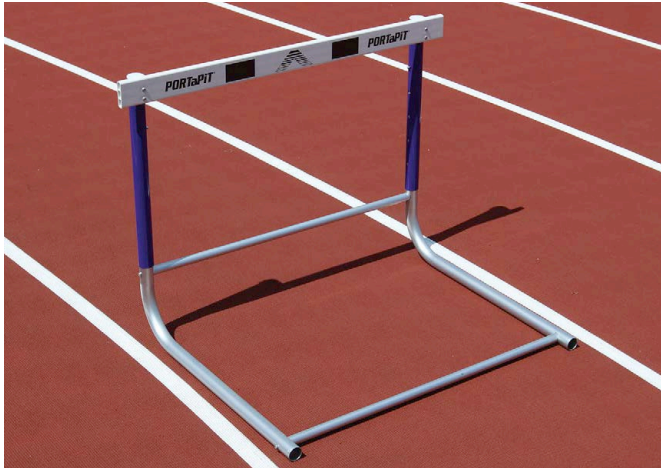

**COMPETITION ROCKER**

- Meets NFHS specifications
- Lightweight, high quality anodized aluminum alloy
- Impact absorbing PVC gateboard

GAAHSRX Specify Riser Color \$164<sup>22</sup> EA ★



**HIGH SCHOOL ALUMINUM**

- Meets NFHS specifications
- Lightweight, high quality anodized aluminum alloy
- Impact absorbing PVC gateboard

GAAFURY Specify Riser Color \$109<sup>22</sup> EA ★



**HIGH SCHOOL STEEL**

- Meets NFHS specifications
- Strong, all steel construction
- Impact absorbing PVC gateboard

GAAHSST Specify Riser Color \$94<sup>22</sup> EA ★

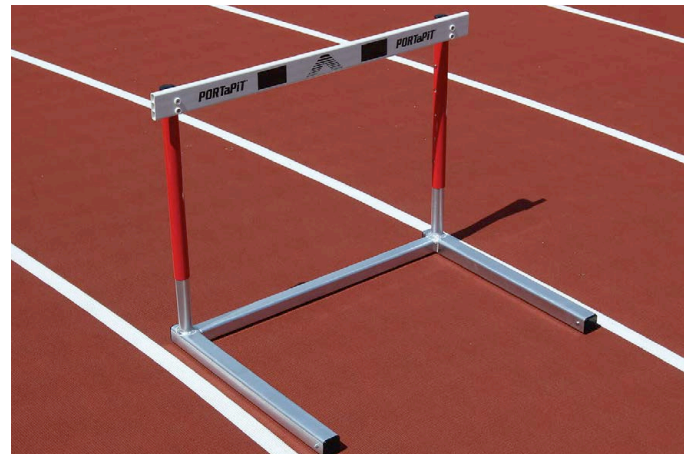

**ADVANTAGE**

- Meets NFHS and NCAA specifications
- Strong high quality mill finish aluminum
- Concealed EZ glide weights to meet official pullover standards

GAAADVA Specify Riser Color \$209<sup>22</sup> EA ★



**STANDARD HURDLE BOARD PRINTING**

Standard printing on boards, 1-color with block lettering

GA945 59 Hurdles or Less/per order \$45<sup>00</sup> PER ORDER

**CUSTOM HURDLE BOARD PRINTING**

Custom printing on boards, up to 4-colors with logo

GA946 59 Hurdles or Less/per order \$70<sup>00</sup> PER ORDER

**FREE OFFER!**

Buy 60 hurdles or more and we will place custom lettering on the hurdle board at no charge. Put your mascot or event title on your hurdles! No set-up fee. Please supply your artwork.

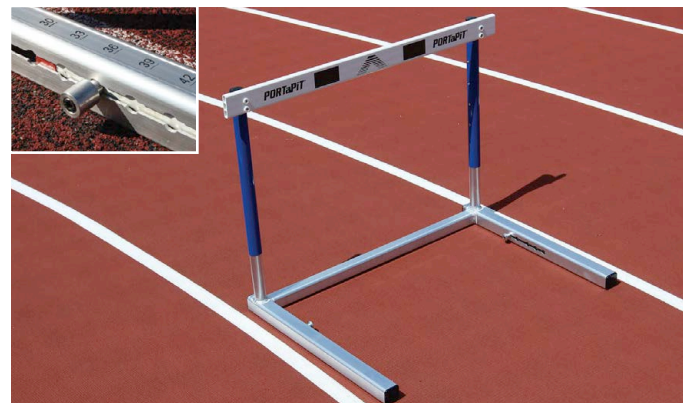

**ELITE**

- Meets NFHS, NCAA and IAAF specifications
- Strong high quality mill finish aluminum
- EZ glide weight presets lock in for precise pullover

GAAFR LH Specify Riser Color \$239<sup>22</sup> EA ★

## DISCS

**GILL**  
ATHLETICS
**HOLLOWOOD STAR™**

- Recommended for all levels
- Straight grained hard rock maple side plates
- High quality steel rim, up to 75% rim weight
- Meets High School and NCAA specifications, IAAF certified

TR300	2K	\$339 <sup>22</sup> EA
TR305	1.6K	\$299 <sup>22</sup> EA
TR313	1K	\$284 <sup>22</sup> EA

**GILL**  
ATHLETICS
**RED**

- ABS plastic side plates
- High quality steel rim
- Up to 80% rim weight
- Meets High School, NCAA, and IAAF specifications

TR303	2K	\$124 <sup>22</sup> EA
TR309	1.6K	\$99 <sup>22</sup> EA
TR312	1K	\$84 <sup>22</sup> EA

**PORTaPiT™****GOLD LO-SPIN**

- Silver Medal winner at the 1996 Games in Atlanta
- Designed for beginner and intermediate throwers
- Constructed of High-impact ABS plastic side plates with a steel rim
- 75% rim weight

ADLS2KGD	2K	\$88 <sup>22</sup> EA ★
ADLSHSGD	1.6K	\$79 <sup>22</sup> EA ★
ADLSIKGD	1K	\$74 <sup>22</sup> EA ★

**PORTaPiT™****CHALLENGER**

- Plastic plated discus
- Priced for general purposes practice or dual meet competition.
- 73% rim weight

1101379	2K	\$53 <sup>22</sup> EA ★
1101386	1.6K	\$49 <sup>22</sup> EA ★
1101393	1K	\$47 <sup>22</sup> EA ★

**PORTaPiT™****Wood**

- Economy wood discus with steel rim
- Ideal for competition as well as practice
- 60-70% rim weight

1101409	2K	\$38 <sup>22</sup> EA ★
1101416	1.6K	\$36 <sup>22</sup> EA ★
1101423	1K	\$34 <sup>22</sup> EA ★

**PORTaPiT™****POPULAR WOOD**

- Center weighted solid wood discus is for the less experienced thrower
- Suggested for distances of 160ft or less this
- Made of fine rock maple with a matched steel rim

AWODDI.6	1.6K	\$44 <sup>22</sup> EA ★
AWODDI.0	1K	\$39 <sup>22</sup> EA ★

**PORTaPiT™****BLACK RUBBER - PRACTICE**

- Affordable hard rubber discus
- Excellent for training at the high school or middle school level.

ARDI.6XX	1.6K	\$12 <sup>22</sup> EA ★
ARDI.0XX	1K	\$11 <sup>22</sup> EA ★

**PORTaPiT™****BLACK RUBBER - OFFICIAL**

- Molded to the official weight and specs
- Recommended for practice and official competition

1101430	2K	\$14 <sup>22</sup> EA ★
1101447	1.6K	\$13 <sup>22</sup> EA ★
1101454	1K	\$11 <sup>22</sup> EA ★

**PORTaPiT™****BROWN INDOOR**

- Special non-marring brown rubber that reduces marks on gym floor
- Meets official weights and specifications
- 78% rim weight

ATFIDI.6	1.6K	\$13 <sup>22</sup> EA ★
ATFIDI.0	1K	\$11 <sup>22</sup> EA ★

SHOTS



**PORTaPiT<sup>®</sup>**  
**BRASS**

- Lathe turned to minimum diameter allowed in competition
- Machine finished for excellent grip and calibrated to exact weight
- Unsurpassed quality
- Meets all Collegiate, International & High School Federation specifications

**ABSHOT12** 103mm 12lbs \$152<sup>22</sup> EA ★



**PORTaPiT<sup>®</sup>**  
**TURNED IRON**

- Solid cast iron shot
- Machine turned to different diameters
- Balanced for high performance throws

**AFSHOT16** 16 lbs-Blue \$74<sup>22</sup> EA ★  
**AFSHOT12** 12 lbs-Silver \$56<sup>22</sup> EA ★  
**AFSHOT4K** 4K-Red \$51<sup>22</sup> EA ★



**PORTaPiT<sup>®</sup>**  
**STEEL**

- Solid steel shot for the advanced thrower
- Machine turned to different diameters
- Lathe turned and balanced for an overall best performance
- Polyurethane paint coated for smooth and durable finish

**1101508** 12 lbs \$99<sup>22</sup> EA ★



**PORTaPiT<sup>®</sup>**  
**INDOOR**

- High visibility red indoor shot has that outdoor shot feel
- Soft enough not to mark or damage the gym or indoor facility floor
- Meets all Collegiate, International & High School Federation specs

**6048XXXX** 4K \$44<sup>22</sup> EA ★  
**6082XXXX** 12lb 5.44K \$54<sup>22</sup> EA ★



**PORTaPiT<sup>®</sup>**  
**COMPETITION**

- Great for high school/middle school practice
- Priced to fit your budget

**ARSHOT12** 12 lbs \$22<sup>22</sup> EA ★  
**ARSHOT4K** 4K \$21<sup>22</sup> EA ★  
**1101591** 8 lbs \$18<sup>22</sup> EA ★  
**1101614** 6 lbs \$16<sup>22</sup> EA ★

**BSN SPORTS**  
**Gym Chalk**  
 Magnesium Carbonate  
 One Pound

**GYM CHALK**

- For weight-lifting or gymnastics
- Conveniently wrapped in 2 oz. blocks
- Eight blocks per 1 lb. package

**PGE4360X** \$15<sup>22</sup> LB ★



**PORTaPiT<sup>®</sup>**  
**SHOT AND DISCUS CARRIER**

- Water resistant polyester carrier holds two discus, two shots or one of each
- Comes with shoulder strap for easy transport

**ASDCXXXX** \$12<sup>22</sup> EA ★



**FIELD DISTANCE MARKERS**

- Markers used to measure competitor's throws
- Chalk may be used to write competitor's name and numbers
- Extremely durable

**1101645** \$45<sup>22</sup> DZN ★



## PORTaPIT<sup>®</sup> COMPETITION 13' 6" DISCUS CAGE

- All aluminum high school discus cage with 6 permanent in-ground sleeves and 4" square posts.
  - Comes complete with sleeve caps.
  - Meets High School specification.
  - Special pulley system allows easy daily removal of netting.
  - 30" cantilever post for Offset netting provides for maximum protection.
  - Net is 1-3/4" weather treated nylon with weighted bottom.
  - Includes spectator warning signs.
- 4 Year Limited Warranty**

<b>AHSDCAGE</b>		\$2,899 <sup>22</sup> EA ★ <b>S&amp;H</b>
<b>SNHSDNET</b>	Replacement Net-13'H x 54'L	\$504 <sup>22</sup> EA ★

## BARRIER NETTING

This barrier netting is an ADDITIONAL 7'H x 61'L piece of netting used for wear and tear on missed throws for existing discus cage netting. This is an optional item for use with your existing discus cage.

**4 Year Limited Warranty**

<b>SNHSDBNT</b>		\$434 <sup>22</sup> EA ★
-----------------	--	--------------------------



## ALUMIGOAL<sup>®</sup> FIBERGLASS MEASURING TAPES

- Durable, long-lasting, vinyl-coated fiberglass tapes in ABS shatter resistant case
- Closed reel tapes feature an easy to wind, flush-folding handle
- Open reel tapes feature easy to wind return, handle and shoulder strap
- Printed with inches/feet on one side and centimeters/meters on the other
- Includes end-loop for one-person measuring

1. <b>MSTAP50X</b>	50'-15M	\$15 <sup>22</sup> EA ★
2. <b>MSTAP100</b>	100'-30M	\$19 <sup>22</sup> EA ★
3. <b>MSTAP165</b>	165'-50M	\$26 <sup>22</sup> EA ★
4. <b>MSTAP200</b>	200'-60M	\$31 <sup>22</sup> EA ★
5. <b>MSTAP330</b>	330'-100M	\$47 <sup>22</sup> EA ★

## MEASURING WHEELS

- All steel construction
- Measures up to 100,000 in feet, inches and tenths or meters, centimeters and decimeters
- Wheel circumference = 4' English and 1 Meter Metric
- Features wheel brake - transport to another site without losing existing measurement

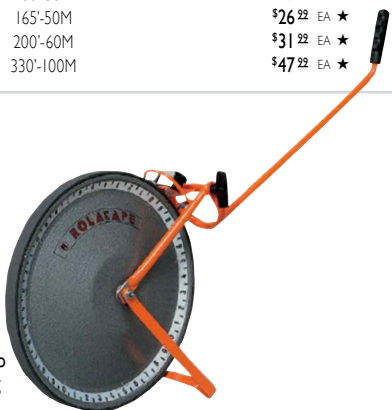

<b>MSTRKMWL</b>	English Measurements	\$234 <sup>22</sup> EA
<b>MSTRKMWM</b>	Metric Measurements	\$234 <sup>22</sup> EA



## PRO DOWN DISCUS CAGES

- Consists of six galvanized 2 3/8"OD, 12 gauge steel upright poles
- Five galvanized steel top rungs helps eliminate neg sag
- The knotless weather treated nylon net has a breaking strength of 180 lbs.
- Comes with ground sleeves

TR80401	Cage with Ground Sleeves	\$1,699 <sup>22</sup> EA	<b>S&amp;H</b>
TR80402	Cage with Plates	\$2,699 <sup>22</sup> EA	
TR80405	Replacement Net	\$1,069 <sup>22</sup> EA	<b>S&amp;H</b>

## TOE BOARDS



### SHOT TOE BOARD

- Polyethylene board shaped to meet official specs
- Super-strong and weather resistant
- Formed holes at each end for securing

1126143	Plastic Poly Board	\$179 <sup>22</sup> EA ★
---------	--------------------	--------------------------

## SHOT/DISCUS CIRCLES

- Aluminum angled construction
- Made of 1" x 3/4" x 1/4 aluminum
- Comes in 4 sections with anchoring holes

1376585	Shot Circle-10 lbs	\$189 <sup>22</sup> EA
1376586	Discus Circle-10 lbs	\$199 <sup>22</sup> EA

## TAKE OFF BOARDS



### COLLEGIATE/HIGH SCHOOL TAKE OFF BOARD

- Made of laminated wood
- Sealed, primed, and finished with white enamel paint
- Meets High School and Collegiate specs

1200485	2.5"H x 8"W x 48"L	\$189 <sup>22</sup> EA
---------	--------------------	------------------------

## ECONOMY MEASURING WHEEL

- Lightweight and extremely durable
- Measures in English up to 10,000 feet
- Handle folds down for easy storage

<b>1378131</b>		\$99 <sup>22</sup> EA ★
----------------	--	-------------------------



**LAP COUNTER WITH BELL**

- Easy to read numbers mounted in an aluminum frame
- Each number goes from 0-9
- Sturdy, lightweight and easy to move

AFLCBXXX \$469<sup>22</sup> EA



**RACE CLOCKS**

- Six digit race clocks with 9" tall digits
- Count up/count down capability in seconds or hundredths of seconds
- Powered by 120V AC or external 12V battery
- Tripod and small remote control included with all race clocks (end mounted controls for direct operation)

1384907	9" Digit Race Clock	\$2,799 <sup>22</sup> EA
1384908	Carrying Case	\$629 <sup>22</sup> EA
1384909	Double-Sided Race Clock	\$3,699 <sup>22</sup> EA
1384910	12V Battery	\$69 <sup>22</sup> EA



**PERFORMANCE INDICATOR-4 DIGIT**

- Four digit indicator
- Aluminum construction with steel base
- Transport wheels

AFPIXXXX \$569<sup>22</sup> EA



**JUDGES STAND**

- Measures 4'W x 9.5'D x 7'H
- Seats 10-people or 20-people can stand
- Handrail for top three levels
- 8"D wheels for transport.

AATRACKS \$1,099<sup>22</sup> EA

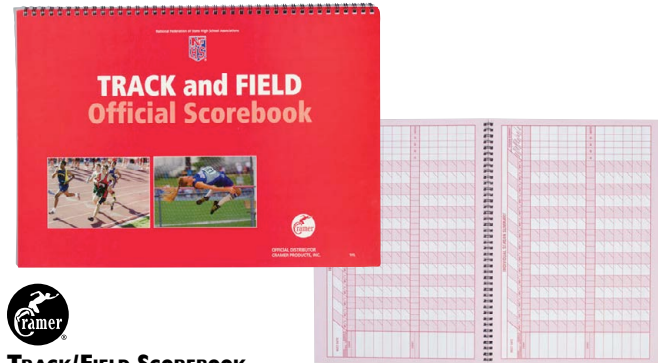

**TRACK/FIELD SCOREBOOK**

- NFHSSA® High School Track/Field Scorebook
- Includes enough pages for full season of meets
- Spiral-bound

I372413

\$14<sup>22</sup> EA

**NEW! Robic TIMING CLIPBOARD**

- Clipboard with stopwatch and calculator
- Stopwatch and calculator can be run simultaneously
- Solar or battery powered
- Dimensions: 14"H x 9"W

I188288

\$34<sup>22</sup> EA

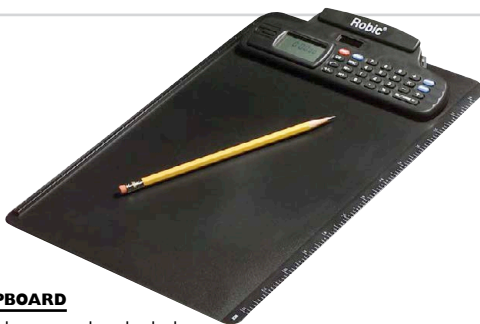

**ROLLOUT RUNWAY**

- Our 10mm rollout runway installs in seconds with no bonding necessary.
- Solve your runway problems and protect your track
- Available in 30", 36", 42" and 48" widths.
- Roll up after use for easy transportation and storage.

AFRUN10M

\$4<sup>22</sup> SQ.FT



**LANDING ZONE™ PIT COVERS**

- Landing Zone ballasted pit protectors keeps sand in...even in high winds, but keeps cats and kids out.
- Steel chain edge hem all around keeps protector down in high winds.
- All units are made to the specific size ordered.
- Pit will **not** stay dry in the event of rain!
- **Add 2' to each dimension so the protector extends over the pit and onto the track.**
- Colors: **Black, Dk Green, Maroon, Navy, Red, Royal, Orange, White, Yellow**

I298017	Vipol® Matrix Material	\$2 <sup>24</sup> SQ.FT
I298024	Vinyl Polyester Material	\$2 <sup>24</sup> SQ.FT



**MARK1**  
**ECONOMY STOPWATCH**

- Single event watch
- 1/100 second precision with lap counter (1st 30 minutes)
- Beep, beep alarm with chime and snooze
- 12/24 hour display option
- Count up to 23 hrs, 59 min., 59 sec.
- Detachable lanyard

**1266702** Black \$8<sup>99</sup> EA ★  
**1266696** 6 Color Pack \$54<sup>99</sup> PACK OF 6 ★



**MARK1**  
**106L STOPWATCH**

- Single events and time outs
- Cumulative splits, 1-2 Fast Finish
- 1/100 second with lap
- Daily alarm and hourly chime

**1269062** Black \$10<sup>99</sup> EA ★  
**1269079** 8 Color Pack \$74<sup>99</sup> PACK OF 8 ★



**SPORTLINE**  
**ALLSPORT 220 STOPWATCH**

- Times single events and time-out activities
- Times cumulative splits
- Times to 24 hours
- Time of day, date and alarms

**MSSTP220** \$19<sup>99</sup> EA



**SPORTLINE**  
**240 STOPWATCH**

- Economical timer at a great price
- Single event/split time watch

**MSSTP240** \$10<sup>99</sup> EA



**SPORTLINE**  
**480 STOPWATCH**

- Two place, fast-finish memory
- Times single events and time-out activities
- Unlimited splits, time/date feature
- Comes with digital tally counter
- 5 Year Limited Warranty

**1337587** \$24<sup>99</sup> EA



**ACCUSPLIT**  
**601X STOPWATCH**

- Times single event and cumulative splits
- 1-2 fast finish, 30 minute range
- 5 year "no proof" warranty
- 2 year battery life

**12440191** \$22<sup>99</sup> EA



**ACCUSPLIT**  
**AX725 STOPWATCH**

- 16 Dual split memory
- Dual split (lap & cum)
- 10 hour range
- Water resistant
- 1.5 year battery life
- 5 Year Limited Warranty

**MSSTP725** \$27<sup>99</sup> EA



**ACCUSPLIT**  
**AX625 STOPWATCH**

- Dual Split (lap and cumulative)
- Times to 10 hrs
- 1-2 fast finish
- Large high contrast LCD display for easy reading
- 5 Year Limited Warranty

**MSSTP625** \$39<sup>99</sup> EA



**Robic**  
**SC-505W STOPWATCH**

- 12 Memory Chrono
- Time events up to 24 hours in 1/100 second resolution
- 12 Memory recall
- Automatic lap count to 199

**MSSTP505** Black \$26<sup>99</sup> EA  
**1240283** 6 Color Pack \$159<sup>99</sup> SET



**Robic**  
**SC-500E STOPWATCH**

- One-step timing for all events
- Start/stop/reset operation
- Water resistant to 30 meters
- Audible beep confirmation or silent operation
- Ideal for finish line volunteers or lane monitor timing

**1378161** \$19<sup>99</sup> EA



**NEW!**  
**Robic**  
**SC-877 TRAINING TIMER**

- Memory recall can be ascending or descending order
- Program up to 3 countdown timers to operate independently or simultaneously

**1389753** \$49<sup>99</sup> EA



**EKHO™ STOP WATCHES**



**NEW!**

**K-350 STOPWATCH**

- 100 Lap and split memory with 1/100 second precision
- Individual lap time, total time, fastest lap, average lap time calculation
- Two individual daily alarm
- Two row time, date, and day display
- 5 Year Limited Warranty**

1376386

\$25<sup>99</sup> EA ★



**NEW!**

**K-250 STOPWATCH**

- 30 laps and split memory with 1/100 second precision
- 2 line display
- Fastest lap and slowest lap calculation
- Countdown timer
- 5 Year Limited Warranty**

1376385

\$18<sup>99</sup> EA ★



**NEW!**

**K-150 STOPWATCH**

- 1/100 second precision with lap counter(for the first 30 minutes)
- Calendar and Time display(12/24 hr format)
- Daily alarm
- Hourly chime
- 5 Year Limited Warranty**

1376384

\$16<sup>99</sup> EA ★



**NEW!**

**ULTRAK...**

**460SET 16 MEMORY STOPWATCHES**

- 16 lap or cum split recallable memory
- Recall and take splits during operation
- Lap counter to 99
- Water resistant
- Set includes six stopwatches (one each of blue, green, orange, purple, red and yellow)
- 5 Year Limited Warranty**

1380590

Set of 6

\$134<sup>99</sup> SET



**ULTRAK...**

**495 STOPWATCH**

- 100 dual split recallable memory
- Takes splits from within recall mode
- Time, calendar and alarm
- Water resistant; lithium battery
- 5 Year Limited Warranty**

1188271

\$49<sup>99</sup> EA



**ULTRAK...**

**360 STOPWATCH**

- 30 dual splits recallable memory
- Lap/cumulative splits
- Recalls times forwards/backwards
- Measures to 10 hours, time and calendar, alarm
- Comes with lithium battery
- 3 Year Limited Warranty**

1151824

\$28<sup>99</sup> EA



**ULTRAK...**

**340 STOPWATCH**

- Display of cumulative splits
- Large numerical display
- Time, calendar, alarm
- Water resistant
- Comes with lithium battery
- 3 Year Limited Warranty**

1151830

\$17<sup>99</sup> EA

**ULTRAK...**

**L10 8-LANE TIMER**

**Road Race (Cross Country) Mode**

- 8,000 memory for individual finishers in single or multiple events
- Four digit bib numbers, four digit place counter
- Bib number entry at finish or add/edit after event
- Automatic print out during event
- Single and multiple start times, up to 99 waves in multiple start race

**Track Race Mode**

- 8 lap/split lane buttons
- Linkgate allows single wire to lane timer, eliminates tangled wires
- 8,000 dual split memory for single or multiple events
- Four digit bib numbers

**Automatic printout of date, run number and record type**

1151794

1151800

Thermal Paper for L10-Box of 3

\$839<sup>99</sup> EA

\$24<sup>99</sup> BOX OF 3



**ULTRAK...**

**499 STOPWATCH & PRINTER**

- Stopwatch system with a portable printer
- 500 lap dual memory that stores lap and cumulative times
- Events are kept in memory segmented by date and run number; all data can be printed out or printed after event
- Dual countdown timer and automatic split release
- 5 Year Limited Warranty**

MSSTP499SP

MSSTPP25

EXTRA PRINTER PAPER ROLLS-Box of 25

\$369<sup>99</sup> EA

\$49<sup>99</sup> BOX OF 25



## GAME BALLS



molten

**SUPER TOUCH**

- Premium Japanese leather cover
- Uni-bladder cotton wrapped construction
- Official volleyball of the NCAA® Women's Championships

1273656 \$62.22 EA



molten

**SUPER TOUCH**

- Premium Japanese leather cover
- Uni-bladder cotton wrapped construction
- NFHS approved

1376587 Royal/Silver/White \$59.22 EA  
1273663 White \$59.22 EA**PERFECTION® 15-0**

- Top-Grade Leather Cover
- Total Feel Technology
- Indoor use only

1376345 Red/White/Blue \$64.22 EA

**PERFECTION® 15-0**

- Top-Grade leather cover
- Total Feel Technology™
- Indoor use only

1301311 White \$66.22 EA  
1323108 Blue/White/Gray \$66.22 EA

SPALDING

**TF-VB5**

- Select Japanese leather cover
- 2-ply soft cloth lining inside
- Floating butyl bladder
- Indoor use only

1375652 \$62.22 EA



SPALDING

**TF-VB1**

- Performance composite PU cover material
- V-seam construction
- Indoor use only

1375653 \$41.22 EA



MIKASA SPORTS

**VQ2000**

- Microcell composite leather cover
- "Accu-Balance" true shape retention
- Indoor use only
- 2 Year Limited Warranty

VBVQ2000 \$44.22 EA



Wilson

**I-COR HIGH PERFORMANCE**

- Japanese full-grain leather cover
- i-COR construction
- Latex Power lining
- Indoor use only

1335682 White \$63.22 EA  
1384918 Red/White/Blue \$63.22 EA

## TRAINING

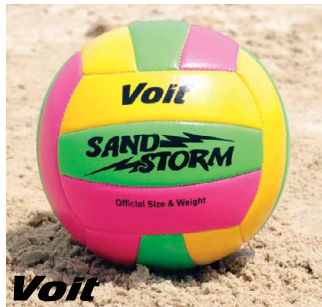

Voit

**SANDSTORM**

- Soft, synthetic leather cover
- Machine sewn panel construction
- Indoor/Outdoor use

1262650 \$14.22 EA ★



Voit

**SANDSTORM II**

- PU synthetic cover
- Machine sewn panel construction
- Indoor/Outdoor use

1297935 \$21.22 EA ★



MacGregor

**CROSS COURT**

- Aerosoft foam rubber cover
- Indoor/Outdoor use
- Color Options: Green/Pink/Yellow, Royal/White/Yellow, Yellow/Purple/Green.

1282405 Specify Color \$12.22 EA ★

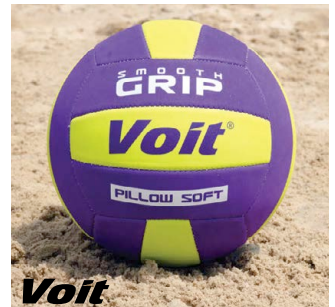

Voit

**SMOOTH GRIP**

- Smooth textured PU cover
- Machine sewn panel construction
- Indoor/Outdoor use

1262667 \$18.22 EA ★

## OUTDOOR



Wilson

**SOFT PLAY**

- Machine sewn with synthetic leather cover
- Excellent air and shape retention
- Indoor use only

1014167 \$14.22 EA



Voit

**BUDGET VOLLEY TRAINER®**

- Sponge-like vinyl cover
- 25% larger and 40% lighter than an official volleyball
- Economical training ball

VVBUDVT Blue/Yellow \$18.22 EA ★  
1297911 Red/Yellow \$18.22 EA ★

Voit

**ENDURO VOLLEY TRAINER®**

- Non-sting synthetic cover
- 25% larger, 40% lighter than standard ball
- Great ball for developing quickness and control

VVBVOLL Yellow \$24.22 EA ★



Voit

**LIGHT SPIKE**

- Double knit soft polyester fabric cover allows players to practice skills without discomfort
- 30% lighter than official volleyball
- Ideal trainer for developing fundamentals safely

1342536 \$13.22 EA ★

## INDOOR



**MacGregor**

**NFHS<sup>®</sup>**  
APPROVED

**X770 PREMIUM**

- Premium Japanese leather cover
- Competition game ball
- True balance technology
- Indoor use only
- **2 Year Limited Warranty**

MCV770WH

\$48<sup>99</sup> EA ★

## TOURNAMENT TESTED!

**BEST  
SELLER**

**NFHS<sup>®</sup>**  
APPROVED

**MARK I VOLLEYBALL**

- Japanese cordley composite leather cover
- Microfiber backing for soft touch feel
- Floating bladder
- Indoor use only

1235593

\$34<sup>99</sup> EA ★



**MacGregor**

**NFHS<sup>®</sup>**  
APPROVED

**X660 Soft Touch**

- Full grain cowhide leather cover
- Competition game ball
- True balance technology
- Indoor use only
- **2 Year Limited Warranty**

MCV660WH

\$39<sup>99</sup> EA ★



**MacGregor**

**X600 COMPOSITE**

- HQ Composite leather cover
- Soft touch technology
- Floating bladder
- Indoor use only
- **2 Year Limited Warranty**

MCV600WH

\$26<sup>99</sup> EA ★



**NEW!**

**YMCA HERITAGE VOLLEYBALL**

- Soft touch high quality composite leather cover
- Official size and weight

1384328

\$25<sup>99</sup> EA ★



**MacGregor**

**XL20 COMPOSITE**

- Composite leather cover
- Exclusive shape retention bladder
- Indoor use only
- **2 Year Limited Warranty**
- Color Options: Navy/White, Royal/White, Scarlet/White, White, White.

MCVL20WH

Specify Color \$19<sup>99</sup> EA ★

**MacGregor** **NFHS<sup>®</sup>**  
APPROVED

**X1000 GAME COMPOSITE**

- Soft composite leather cover
- Floating bladder construction
- Available in 7 colors
- Indoor/Outdoor use
- Color Options: Black/White, Navy/White, Royal/White, Scarlet/White, Scarlet/White/Black, Scarlet/White/Royal, White.

MCV1000W

Specify Color \$33<sup>99</sup> EA ★



## RUBBER

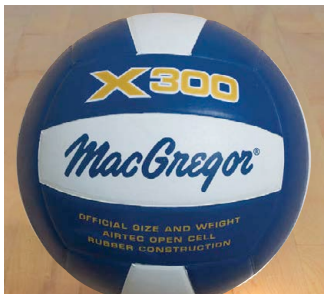

**MacGregor**

**X300 RUBBER COVER**

- Airtec Open Cell molded rubber cover allows for a thicker rubber without additional weight
- Smoother and softer feel with increased gripability
- Indoor/Outdoor use

1272772

\$10<sup>99</sup> EA ★



**Voit**

**CV4 "SOFT SHOT" STINGLESS**

- "Sting-free" Syn-Tec<sup>®</sup> rubber cover
- Special foam coating makes it durable and soft
- Indoor/Outdoor use
- **2-year Limited Warranty**

VCV4HXXX

\$14<sup>99</sup> EA ★

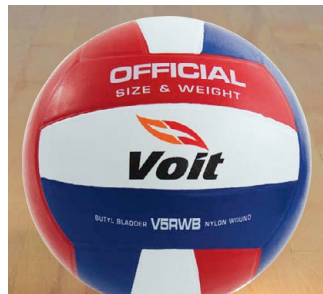

**Voit**

**V5RWB RUBBER COVER**

- Molded composition rubber cover
- Nylon wound bladder
- Indoor/Outdoor use

1272765

\$9<sup>99</sup> EA ★

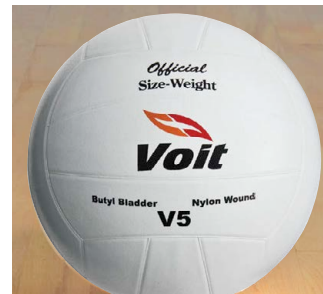

**Voit**

**V5 RUBBER COVER**

- Molded composition rubber cover
- Nylon wound bladder
- Indoor/Outdoor use

VV5HXXXX

\$7<sup>99</sup> EA ★

## TACHIKARA TRAINING



### VOLLEY-LITE®

- Sensi-Tec® microfiber composite cover
- Regulation size but lighter weight for younger players
- Helps develop novice players skills faster
- Indoor use only

<b>20011575</b>	White	\$37 <sup>22</sup> EA
1050905	Scarlet/White/Royal	\$37 <sup>22</sup> EA
1155549	Additional Colors	\$36 <sup>22</sup> EA

### ADDITIONAL COLORS



### HAMMOCK BALL CART

- Tubular galvanized steel frame
  - Low profile design makes it easy to turn, reach and spike
  - Collapsible unit that stores in carry bag (Included)
  - Holds 24 balls
  - 48" L x 22" W x 12" D x 40" H - 13 lbs.
- Color Options: **Black, Navy, Royal, Scarlet.**

1155389	Specify Color	\$149 <sup>22</sup> EA
---------	---------------	------------------------



### TB-18 "THE SETTER"™

- Sensi-tec® micro-fiber composite cover
- Weighted ball builds hand/finger strength
- Weight: 15.7 - 17.5 oz.
- Indoor use only

1091991	\$46 <sup>22</sup> EA
---------	-----------------------

## TACHIKARA OUTDOOR

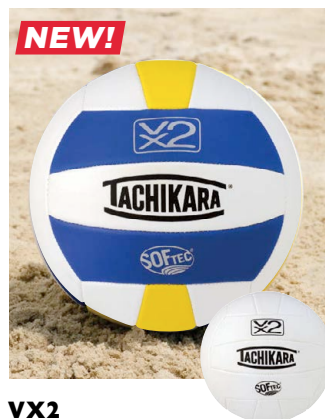

### VX2

- Sof-Tec foam-backed panel volleyball
- Machine-stitched construction
- Butyl bladder
- Ideal for camps, P.E. and recreational

<b>1388863</b>	White	\$19 <sup>22</sup> EA
<b>1388864</b>	Royal/White/Yellow	\$19 <sup>22</sup> EA

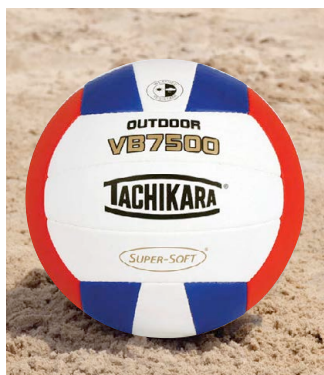

### VB7500

- "Super Soft" composite leather cover
- Machine stitched reinforced seams
- Indoor/Outdoor use

1387791	Scarlet/Royal/White	\$34 <sup>22</sup> EA
---------	---------------------	-----------------------

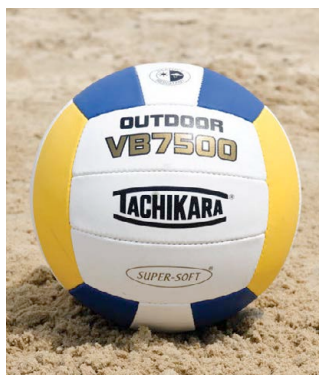

### VB7500

- "Super-Soft"® composite leather cover
- Machine stitched reinforced seams
- Indoor/Outdoor use

1245509	Gold/White/Blue	\$34 <sup>22</sup> EA
---------	-----------------	-----------------------



### SV12R "SUPER-SOFT"®

- "Super-Soft"® rubber cover preferred by younger players
- Nylon-yarn winding provides extra durability
- Indoor/Outdoor use

<b>TACSV12R</b>	\$18 <sup>22</sup> EA
-----------------	-----------------------

## INDOOR

### 36 ADDITIONAL COLORS

#### Additional Colors

Minimum order of 3

Black/Wht/Vintage Gold  
Black/Wht/Silver Gray  
Cardinal/Wht/Silver Gray



Cardinal/Wht/Vintage Gold  
Cardinal/Wht/Black  
D. Green/Wht



D. Green/Wht/Silver Gray  
D. Green/Wht/Vin. Gold  
Navy/Wht/Silver Gray



Navy/Wht/Vintage Gold  
Navy/Wht/Gold  
Orange/Wht/Royal



Pink/Wht  
Pink/Wht/Black  
Powder Blue/Wht



Gold/Wht/Black  
Pow. Blue/Wht/Navy  
Pow. Blue/Wht/Silver Gray



Purple/Wht/Silver Gray  
Royal/Wht/Silver Gray  
Royal/Wht/Black



Scarlet/Wht/Silver Gray  
Scarlet/Wht/Navy  
Lime Green/Wht



Cardinal/Wht  
Cardinal/Wht/Gold  
Gold/Wht



Gold/Wht/Dark Green  
Royal/Wht/Gold  
Purple/Wht/Gold



Orange/Wht  
Orange/Wht/Black  
Orange/Wht/Navy



Purple/Wht  
Pow. Blue/Wht/Black  
Teal/Wht/Black



### 6 IN-STOCK COLORS



#### SV-5WSC "SENSI-TEC"® COMPOSITE

- All colors are NFHS approved

1072266 Specify Color \$39<sup>99</sup> EA



#### SV-5WS "SENSI-TEC"® COMPOSITE

- Sensi-Tec™ micro-fiber composite leather cover
- Patented Loose Bladder Construction(LBC®)
- Hand finished panels and seams
- Indoor use only

TACSV5WS White \$39<sup>99</sup> EA



#### SV-5W GOLD LEATHER

- U.S. Premium leather cover
- Patented Dual Bladder Construction(DBC®) for a more responsive and controlled touch
- Impact reducing air layer buffers and evenly disperses force of digs, passes and spikes
- Indoor use only

TACSV5WX White \$59<sup>99</sup> EA  
1050912 Red/White/Blue \$59<sup>99</sup> EA



#### SV-5WH LEATHER

- Top Grade Leather cover
- Patented Loose Bladder Construction(LBC®)
- Indoor use only

TACSV5WH \$54<sup>99</sup> EA



#### SV-18S COMPOSITE

- Woven-fiber v100 composite
- Single Unit Construction(SUC®)
- Indoor use only

1233124 \$35<sup>99</sup> EA



#### SV-5WM LEATHER

- Perfect value for practice in team white or team colors
- Full Grain Leather cover
- Indoor use only

Color Options: Black/White, Cardinal/White, Collegiate Blue/White/Silver, Dark Green/White, Navy/White, Pink/White, Purple/White, Royal/White, Scarlet/White, Scarlet/White/Black, Scarlet/White/Royal, White.

1371299 Specify Color \$37<sup>99</sup> EA



#### SV-18L LEATHER

- Full Grain Leather cover
- Patented Loose Bladder Construction(LBC®)
- Indoor use only

TACSV18L \$45<sup>99</sup> EA

## ALUMINUM SYSTEMS



**TITAN**  
**TELESCOPIC ALUMINUM VOLLEYBALL SYSTEM**

- Specially engineered aluminum extrusions create a light weight post with superior strength
- Complete system includes: Clear anodized finished 3.5" O.D. posts with 10-net height adjustment settings, precision worm-gear winch, 2 pole pads (**specify color**), 2 ground sleeves w/floor plates, Ultimate net, antennae, judge's stand and judge's stand safety padding (**specify color**)
- **Center standard available for side-by-side court setup**

Color Options: **Black, Dark Green, Navy, Royal, Scarlet.**

<b>MSUTSXXJ</b>	Complete System	\$2,799 <sup>99</sup>	SET ★	<b>SeH</b>
<b>MSUTSXXXA</b>	System w/o Ground Sleeves	\$2,599 <sup>99</sup>	SET ★	<b>SeH</b>
<b>MSUTSXXX</b>	System w/o Judge's Stand & Pad	\$2,199 <sup>99</sup>	SET ★	<b>SeH</b>
<b>MSUTSXXB</b>	System w/o Judge's Stand/Pad or Ground Sleeves	\$1,999 <sup>99</sup>	SET ★	<b>SeH</b>
<b>MSUTSCSX</b>	Center Standard & Pad Only	\$1,369 <sup>99</sup>	SET ★	<b>SeH</b>
<b>I23566I</b>	Ultimate Volleyball Net	\$299 <sup>99</sup>	EA ★	

PADS AVAILABLE IN 5 COLORS



### Volleyball Systems-At-A-Glance

X indicates the feature is included with the system

Code	Price	U/M	Ratchet	Antenna	Pole Pads	Net	Judges Stand	Judges Stand Pad	Ground Slvs/ Floor Plates
<b>Hybrid Power System 3" O.D.</b>									
VX2000TS	\$2,249 <sup>99</sup>	SET	X	X	X	X	X	X	X
VX2000A	\$2,049 <sup>99</sup>	SET	X	X	X	X	X	X	
VX2000X	\$1,649 <sup>99</sup>	SET	X	X	X	X			X
VX2000B	\$1,469 <sup>99</sup>	SET	X	X	X	X			
<b>Pro Power Steel System 3.5" O.D.</b>									
MSVBSETJ	\$2,199 <sup>99</sup>	SET	X	X	X	X	X	X	X
MSVBSETA	\$1,999 <sup>99</sup>	SET	X	X	X	X	X	X	
MSVBSETX	\$1,569 <sup>99</sup>	SET	X	X	X	X			X
MSVBSETB	\$1,249 <sup>99</sup>	SET	X	X	X	X			
<b>Telescopic Aluminum System 3.5" O.D.</b>									
MSUTSXXJ	\$2,799 <sup>99</sup>	SET	X	X	X	X	X	X	X
MSUTSXXXA	\$2,599 <sup>99</sup>	SET	X	X	X	X	X	X	
MSUTSXXX	\$2,199 <sup>99</sup>	SET	X	X	X	X			X
MSUTSXXB	\$1,999 <sup>99</sup>	SET	X	X	X	X			

## COMPETITION SYSTEMS

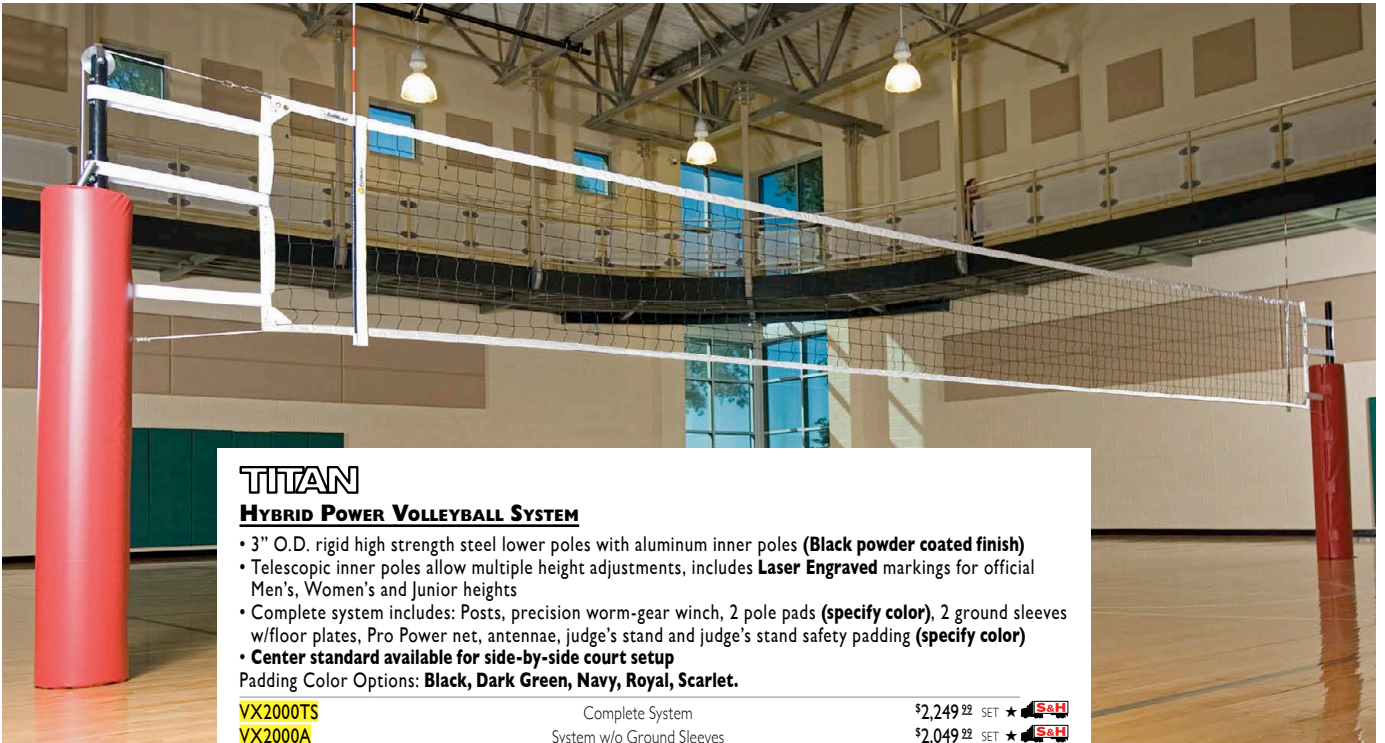

### TITAN

#### HYBRID POWER VOLLEYBALL SYSTEM

- 3" O.D. rigid high strength steel lower poles with aluminum inner poles (**Black powder coated finish**)
- Telescopic inner poles allow multiple height adjustments, includes **Laser Engraved** markings for official Men's, Women's and Junior heights
- Complete system includes: Posts, precision worm-gear winch, 2 pole pads (**specify color**), 2 ground sleeves w/floor plates, Pro Power net, antennae, judge's stand and judge's stand safety padding (**specify color**)
- **Center standard available for side-by-side court setup**

Padding Color Options: **Black, Dark Green, Navy, Royal, Scarlet.**

<b>VX2000TS</b>	Complete System	\$2,249 <sup>22</sup> SET ★ <b>S&amp;H</b>
<b>VX2000A</b>	System w/o Ground Sleeves	\$2,049 <sup>22</sup> SET ★ <b>S&amp;H</b>
<b>VX2000X</b>	System w/o Judges Stand & Pad	\$1,649 <sup>22</sup> SET ★ <b>S&amp;H</b>
<b>VX2000B</b>	System w/o Judges Stand/Pad & Ground Sleeves	\$1,469 <sup>22</sup> SET ★ <b>S&amp;H</b>
<b>VX2000C</b>	Center Standard & Pad Only	\$799 <sup>22</sup> SET ★ <b>S&amp;H</b>
<b>SNINTLVB</b>	Pro Power Volleyball Net	\$159 <sup>22</sup> EA ★

#### PADS AVAILABLE IN 5 COLORS

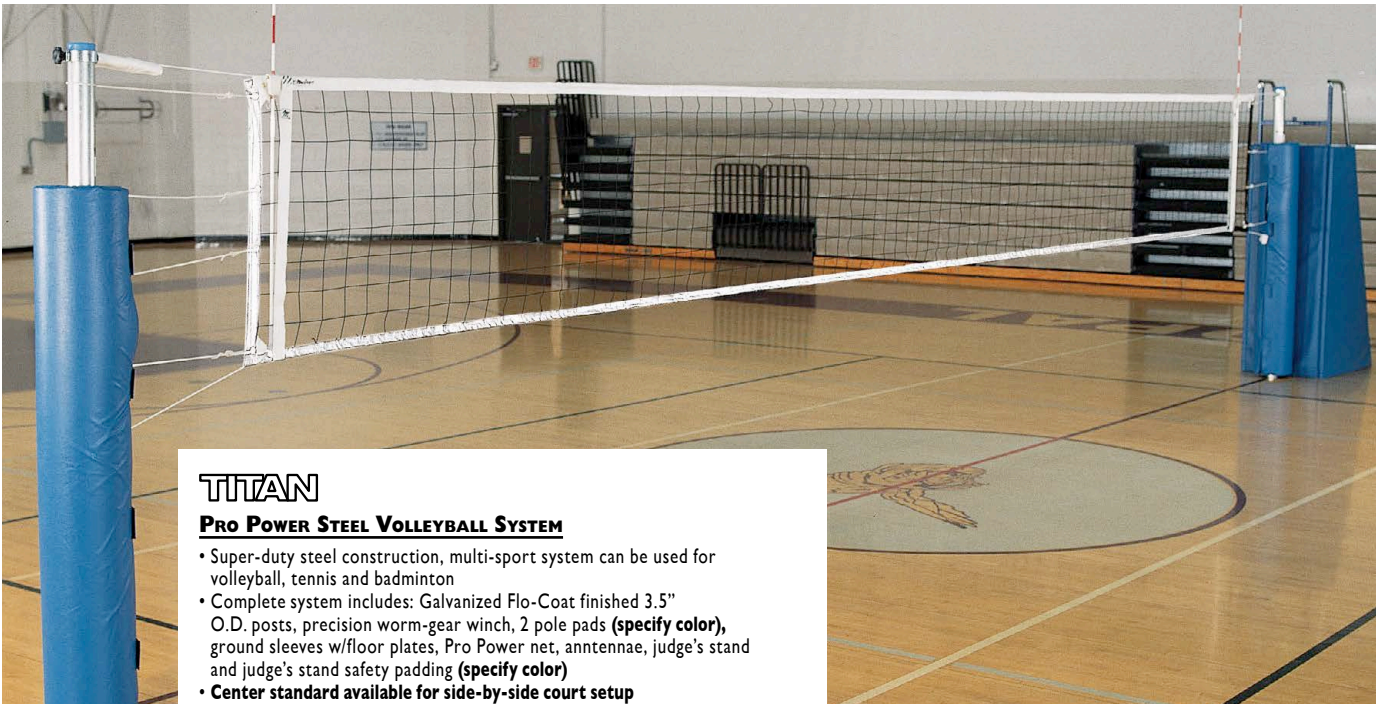
**BLACK**
**DARK GREEN**
**NAVY**
**ROYAL**
**SCARLET**

### TITAN

#### PRO POWER STEEL VOLLEYBALL SYSTEM

- Super-duty steel construction, multi-sport system can be used for volleyball, tennis and badminton
- Complete system includes: Galvanized Flo-Coat finished 3.5" O.D. posts, precision worm-gear winch, 2 pole pads (**specify color**), ground sleeves w/floor plates, Pro Power net, antennae, judge's stand and judge's stand safety padding (**specify color**)
- **Center standard available for side-by-side court setup**

Padding Color Options: **Black, Dark Green, Navy, Royal, Scarlet.**

<b>MSVBSETJ</b>	Complete System	\$2,199 <sup>22</sup> SET ★ <b>S&amp;H</b>
<b>MSVBSETA</b>	System w/o Ground Sleeves	\$1,999 <sup>22</sup> SET ★ <b>S&amp;H</b>
<b>MSVBSETX</b>	System w/o Judge's Stand & Pad	\$1,569 <sup>22</sup> SET ★ <b>S&amp;H</b>
<b>MSVBSETB</b>	System w/o Judge's Stand/Pad or Ground Sleeves	\$1,249 <sup>22</sup> SET ★ <b>S&amp;H</b>
<b>STVBPOLC</b>	Center Standard & Pad Only	\$999 <sup>22</sup> SET ★ <b>S&amp;H</b>
<b>SNINTLVB</b>	Pro Power Volleyball Net	\$159 <sup>22</sup> EA ★

#### FLOOR PLATES/GROUND SLEEVES

- Consists of two separate components. Two aluminum sleeves with a chrome steel cover plate with a hinged lid.

<b>VXGS3.5</b>	Floor Plates/Ground Sleeves for 3.5" System	\$219 <sup>22</sup> SET ★ <b>S&amp;H</b>
<b>VXGS</b>	Floor Plates/Ground Sleeves for 3" System	\$219 <sup>22</sup> SET ★
<b>VXGSC</b>	Converts 3.5" to 3" Sleeve	\$139 <sup>22</sup> PR ★



## SPALDING

### ELITE ALUMINUM SYSTEM

The Elite Aluminum System is lightweight, durable and easy to set up. Meets all USAV, NCAA, NFHS and FIVB specifications. 10-year limited warranty on uprights.

- High strength uprights made of 3" OD extruded aluminum
- Adjustable height worm gear winch which eliminates backlash and gets net tight during play
- Nylon leader strap allows for safety and easy net attachment
- **System includes:** Winch end upright, center upright, 1M Aramid Fiber Net, antennae package, boundary tape, upright pads

#### 10 Year Limited Warranty

1155334 \$3,499<sup>22</sup> SET

#### Upright Package

- Includes: winch end upright, center upright, antennae package and net boundary tape only

1139068 \$2,499<sup>22</sup> SET

#### Elite Aluminum Volleyball System

1M Kevlar Net for the Elite Aluminum Volleyball System

1143478 1M Aramid Fiber Net \$579<sup>22</sup> EA

#### Floor Plates/Sleeves

- Cover plate consists of chromed steel 6-3/4"(17cm) O.D. outer ring and hinged steel cap.
- Heavy-duty steel sleeve receives a 3"(76mm) O.D. upright and is 9-3/32" (23cm) long.

1139075 \$359<sup>22</sup> PR



## SPALDING

### SLIDE MULTI-SPORT SYSTEM

American Athletic's recreational volleyball equipment is built with value, ease-of-use and functionality in mind.

- High strength uprights made of 3" OD aluminum with sliding adjustments, continuous height adjustments.
- Nylon leader strap allows for safety and easy net attachment
- Adjusts for any height for use in volleyball, badminton, tennis
- Easily converts to two-court system
- **System includes:** Slide winch end upright, slide center upright, 36" Quick Set net, antennae package, boundary tape, upright pads.

#### 5 Year Limited Warranty

1157642 \$2,899<sup>22</sup> SET

#### Upright Package

- Includes: slide winch upright and slide center upright only

1157659 \$1,999<sup>22</sup> SET

#### 36" Quick Set Net

1157666 \$429<sup>22</sup> EA



## PORTER

### POWR-RIB II INTERNATIONAL VB Pkg

- Constructed of high strength, lightweight aluminum, easy for installation
  - Standards are compatible with 3.5" diameter floor sleeves
  - Package includes: **Standards, protective pads, competition net 37'6" kevlar top cable net, antennas, net chain, judges stand, judges stand padding**
- Color Options: **Black, Dark Green, Grey, Kelly Green, Maroon, Navy Blue, Orange, Purple, Red, Royal, Sky Blue, Tan, White, Yellow Gold.**

1376589 \$3,349<sup>22</sup> SET



## PORTER

### POWR-RIB II® ALUMINUM STANDARDS

- Posts are lightweight aluminum one piece design
- Features built-in channel with collar slides for height adjustment using a pressure lock T-handle with positive locking feature
- Includes visual labels for official men's, women's and junior height settings and Powr-Winch® net tensioning mechanism with positive disc brake release

P01971	3.5" Poles	\$1,499 <sup>22</sup> PR
P01972	Single Center Standard-3.5"	\$929 <sup>22</sup> EA
P01973	3" Poles	\$1,599 <sup>22</sup> PR
P01974	Single Center Standard-3"	\$1,099 <sup>22</sup> EA
P02295	POWR-LINE® Net - 39'-6"L Kevlar Top Cable	\$319 <sup>22</sup> EA
P02255	POWR VB Net - 44'L Vinyl Coated Top Cable	\$219 <sup>22</sup> EA
I376588	POWR-LINE® Net - 37'-6"L Kevlar Top Cable	\$299 <sup>22</sup> EA
K72363	Powr Line Net Antennae	\$149 <sup>22</sup> PR
P02297	Powr Line Boundary Markers	\$59 <sup>22</sup> PR



## PORTER

### DELUXE POLE PADS

- Tailored pads are miter cut and hinged to fold neatly around uprights and winch
- Color Options: **Beige, Black, Blue, Dark Green, Grey, Maroon, M Green, Navy, Orange, Purple, Red, Royal Blue, White, Yellow.**

P008390	End Pole Pads	\$549 <sup>22</sup> PR
P008391	Center Pole Pad	\$399 <sup>22</sup> EA



## FREE PAD LETTERING



### CENTERLINE ELITE ALUMINUM SYSTEM

- Centerline aluminum systems are designed to provide the bowstring tight net tension insisted on by top programs without extra weight
- Centerline system height adjustment is made easy with Auto Track spring assisted telescoping piston design. Height variable from 72" to 96" with easy-to-read height adjustment indicators
- The powder coated standards and winch are covered by a **limited lifetime warranty**
- System includes: 3" aluminum telescoping poles, net tensioning winch, Kevlar top rope net, Centerline antennae, two 1 1/2" thick x 72"H pole pads (**specify color**), cable covers and 2 ground sleeves with brass floor plates
- Call for assistance if your existing sockets are more than 12" deep
- Centerline Clear View padded official's stand sold separately**

VB100065 \$3,599<sup>22</sup> SET

#### Complete System Without Ground Sleeves

Complete Centerline Aluminum System with 3" aluminum telescoping and winch, Kevlar top rope net, Centerline antennae and pole pads (**specify color**)

VB100065WO \$3,299<sup>22</sup> SET

ACCESSORIES		
VB125065	Kevlar Top Rope Net	\$399 <sup>22</sup> EA
VB50P65	Centerline Pole Padding - Specify Color	\$599 <sup>22</sup> PR
I071580	Screen Printing-up to 10 block letters-Per location	\$159 <sup>22</sup> EA
VB7365	Centerline Clear View Judges Stand w/ Grey padding only	\$999 <sup>22</sup> EA
VB2365	3" Floor sockets with Brass Floor Plates	\$279 <sup>22</sup> EA
VB15065	Centerline Antennae	\$199 <sup>22</sup> EA

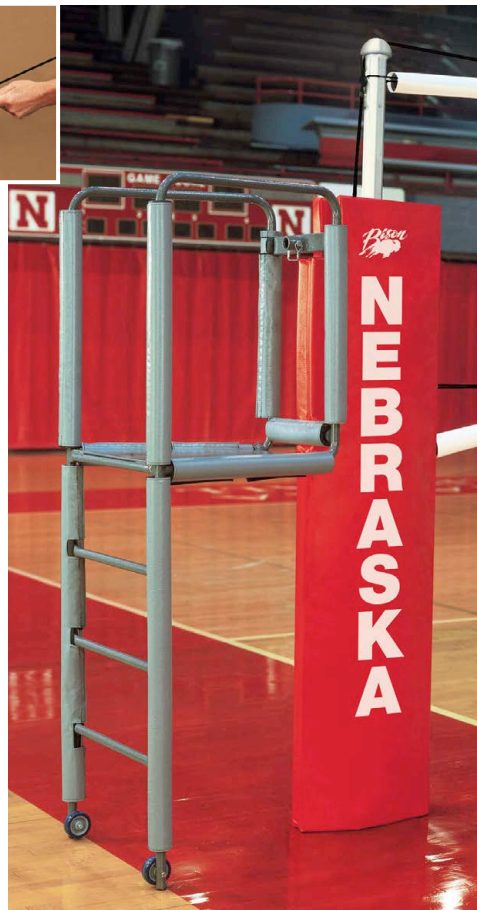
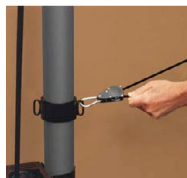

VOLLEYBALL

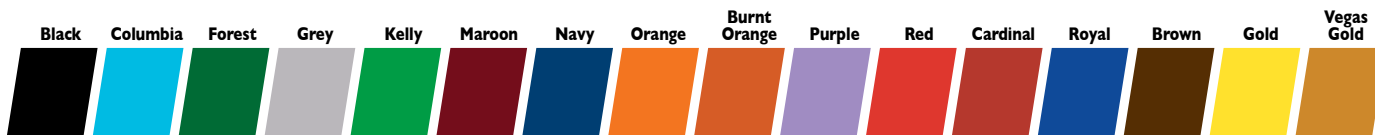

## FREE PAD LETTERING



### MATCHPOINT ALUMINUM SYSTEM

- Maximum versatility, maximum value, heavy wall 3.5" aluminum extruded posts with powder coated finish
- Height adjust channel system with easy to read height indicators on both poles. Height variable from 42" to 96" for all levels of competition volleyball play, plus tennis, badminton, pickleball and other net games
- System includes: Poles, Kevlar top rope net, tensioning winch, antennae, pole pads (**specify color**) and 2 ground sleeves with brass floor plates

#### 10 Year Limited Warranty

I263206 \$2,999<sup>22</sup> SET

#### Complete System Without Ground Sleeves

Complete Matchpoint System with 3.5" aluminum posts, net tensioning winch, Kevlar top rope net, antennae and pole pads (**specify color**)

I263213 \$2,399<sup>22</sup> SET

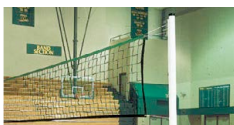

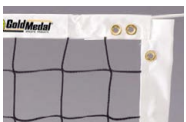
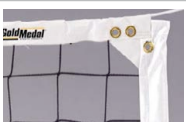
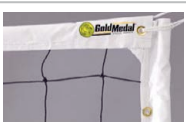
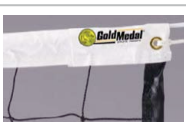
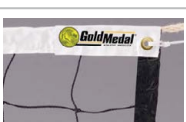
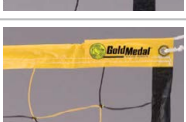
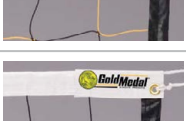

## VOLLEYBALL NETS

NETS	USES	SIZE/BODY	HEADBAND	BOTTOM	CABLE	PRICE/CODE
	<b>ULTIMATE VOLLEYBALL NET</b>		2" HD white polyester	1 1/4" HD white polyester side pockets; fiberglass dowels w/ 3 intergrated D-Rings white nylon webbing tension straps	34' Aramid fiber top Nylon rope bottom	\$299 <sup>22</sup> EA ★ <b>I23566I</b>
	Telescopic Aluminum System AAI Systems	32' x 1m, 3.0mm braided knotted nylon				
	<b>MASTER VOLLEYBALL NET</b>		18 oz coated vinyl top	18 oz vinyl w/ fiberglass dowels, 14 oz coated vinyl bottom	45' Aramid fiber top Nylon rope bottom	\$159 <sup>22</sup> EA ★ <b>SNMCMAS2</b>
	Senoh & most Power VB systems	32' x 1m, 3.5mm braided knotless HTPP				
	<b>PRO POWER VOLLEYBALL NET</b>		14 oz laminate vinyl top/bottom	14 oz laminate w/ fiberglass dowels	34' PVC coated steel top cable w/ 3' 6" leader cable includes net tension straps	\$159 <sup>22</sup> EA ★ <b>SNINTLVB</b>
	VX2000 System PPS Steel System	32' x 1m, 3.5mm braided knotless nylon				
	<b>PRO POWER 2 VOLLEYBALL NET</b>		2" HD 14 oz vinyl top/bottom	Steel dowels w/ synthetic leather cover 14 oz vinyl	40' L 1/8" thick coated steel top and bottom	\$84 <sup>22</sup> EA ★ <b>SNVBSP32Y</b>
	Systems w/ Double Ratchets	32' x 3', 2.5 mm polyethylene twisted knotted				
	<b>SPORT VOLLEYBALL NET</b>		1.5" HD 14 oz vinyl top w/ 1.5" bottom	10 oz vinyl coated tape	40' L 1/8" thick coated steel top w/ vinyl coated tape bottom	\$57 <sup>22</sup> EA ★ <b>SNVBC32Y</b>
	HS Physical Education ST240PWR	32' x 3', 2mm polyethylene twisted knotted				
	<b>RECREATIONAL VOLLEYBALL NET</b>		1.5" HD 10 oz vinyl top	10 oz vinyl coated tape	1/4" thick rope top	\$39 <sup>22</sup> EA ★ <b>SNVBC</b>
	Jr High Phys Ed ST240S/P ST240C/S	25', 27', 30', 32' x 3' Specify length 2mm polyethylene twisted knotted				
	<b>MULTI-COLOR ECONOMY NETS</b>		1.5" HD 10 oz vinyl top	10 oz vinyl coated tape	40' L 5/32" thick polyester rope top	\$30 <sup>22</sup> EA ★ <b>I0486I2</b> Yellow/Blk
	Recreational Play	32' x 3' 2 tone polyethylene 2mm twisted knotted				
	<b>ECONOMY VOLLEYBALL NET</b>		1.5" HD 10 oz vinyl top	10 oz vinyl coated tape	40' L 5/32" thick polyester rope top	\$26 <sup>22</sup> EA ★ <b>SNVBECO2Y</b>
	Elementary Physical Education	32' x 3', 1.75mm polyethylene twisted knotted				

**VB NET STORAGE SYSTEM**

Net storage system for 3 nets

1238822	3 Nets	\$349 <sup>22</sup> EA
1238815	2 Nets	\$299 <sup>22</sup> EA
1238808	1 Net	\$269 <sup>22</sup> EA

**porter**  
**WALL STORAGE RACK**

- Secures 2 volleyball poles in place with lock included
- Holds pole up to 3.5" in diameter

1366544 \$139<sup>22</sup> EA**FLOOR MARKING TAPE**

- Use on any smooth floor surface

Color Options:

**Black, Blue, Green, Gold, Orange, Purple, Red, White.**

<b>FTAP16</b>	1" x 60 Yd.	\$5 <sup>62</sup> EA ★
<b>FTAP26</b>	2" x 60 Yd.	\$8 <sup>22</sup> EA ★

**FLOOR TAPE APPLICATOR**

- Sturdy steel applicator
- Ideal for laying up to 2"W single sided tape
- Use for straight or curved lines

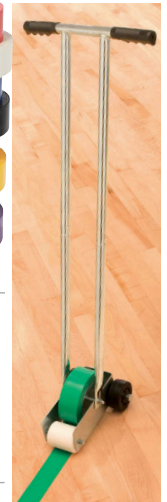
**MSTAPMACY** \$41<sup>22</sup> EA ★

**NEW!****LINESMAN FLAGS**

- Set of 4 linesman flags with case
- Deluxe aluminum handles with soft grips
- Flag Size: 12" x 12"

1376640

\$41<sup>22</sup> SET**OFFICIAL WALLYBALL® GAME KIT**

Transform unused racquetball courts into an exciting team action court

- Two teams of up to 4 players per team
- Rules and skills are similar to volleyball
- Wallyball® offers more contact than traditional volleyball

Includes: ball, net, net tightener clamp, storage bag, and hardware and instructions for installation

G500KXXX

\$174<sup>22</sup> CT**COURT HARDWARE**

- Includes all hardware to hang one net: anchors, bolts and bushings

G504KXXX

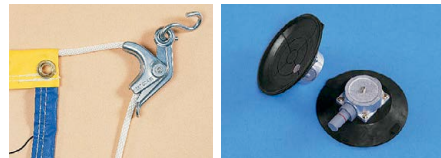
\$60<sup>22</sup> SET**NET CLAMP**

- Net tension clamp for lightweight nets with nylon top ropes

G004KXXX

\$13<sup>22</sup> EA**WALL SUCTION CUPS**

- Rubber suction cups for net attachment on glass walls

1033670

\$95<sup>22</sup> EA**WALLYBALL NET**

- Regulation net with black nylon netting with blue and gold trim
- Net tightener included

G502KXXX

\$134<sup>22</sup> EA**OFFICIAL WALLYBALL® BALL**

- The official bright blue ball of Wallyball®
- Specially developed velvety and durable synthetic cover



G503KXXX

\$18<sup>22</sup> EA ★**VOLLEYBALL PAL**

- Ideal for single player practice servingtosses or arm swing techniques without chasing the ball
- Consists of adjustable waist strap and a neoprene pouch that holds the ball with elastic connecting cord
- Smooth action of cord guides back to player everytime

1238785

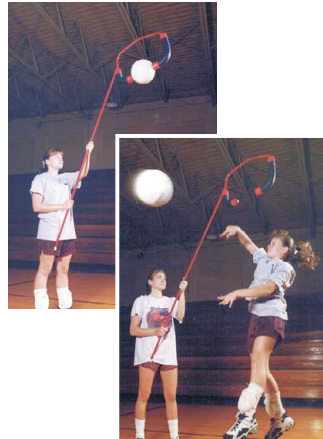
\$29<sup>22</sup> EA**SPIKEBLASTER**

- Suspend ball for spiking practice and teaching
- Maximizes practice time
- Great for all levels of ability

98669XXX

\$144<sup>22</sup> EA**1. TARGET CHALLENGER**

- Adjustable pole height (to 12') and 30" target ring for multi-sport use
- Sturdy net collects balls for easy retrieval
- Includes 22 lb weight for stability and 2 wheels for portability
- Ideal for passing, setting, or shooting
- Pictured with Tandem Colossal Cart

1274424

\$349<sup>22</sup> EA**2. COLOSSAL VOLLEYBALL CART**

- Nylon basket includes side pockets for storage
- Holds 40 volleyballs
- Black only

1274417

38"H x 42"W x 32"D

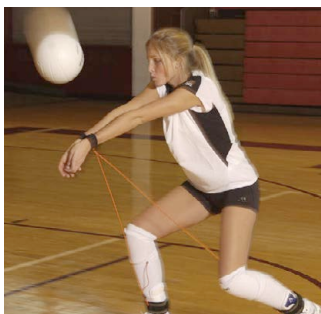
\$199<sup>22</sup> EA**PASS RITE TRAINING TOOL**

- Durable elastic bands prevent excessive upward arm movement
- Attaches to passer's wrists and ankles, designed to minimize ball contact interference
- Adjustable to fit any passer's height

1238792

\$35<sup>22</sup> EA**BUNGEE BLOCKER**

- The ultimate blocking tool!
- Constructed of lightweight aluminum and bungee straps
- Game-like simulation in practice
- Improve hitting placement

1303346

\$94<sup>22</sup> EA**PRACTICE MAKES PERFECT!  
SETTING, PASSING, SPIKING...  
WHATEVER YOU NEED!****VOLLEYBALL TUTOR**

- Can automatically feed up to six volleyballs at intervals ranging from six to twenty seconds
  - Propels volleyballs up to 40' at adjustable angles and speeds
  - Compact design and built-in carry handle for easy storage and portability
  - Requires AC power outlet
- Power Source: AC, Battery.

MSVTUTOR

37"L x 25"W x 16"H - 25 lbs.

\$1,699<sup>22</sup> EA**Remote Control for Volleyball Tutor**

- Foot operated (Cable connected) remote controls the ball feed from as far away as 40'
- Must be ordered at the same time as The Volleyball Tutor

MSVTREMO

Remote Control-Can Not Be Ordered Separately

\$115<sup>22</sup> EA



**MacGregor**

**VOLLEYBALL KNEE PADS**

- 9" elastic knee pad with new design for added knee flexibility
  - Soft but protective poly/cotton/spandex for added comfort
- Color Options: **Black, White.**

**I310177** Specify Color \$15.99 PR ★



**ESSENTIALS KNEE PADS**

- Low profile ergonomic high density protective foam pad
  - Simplified outer design for a minimalistic and streamlined look
  - Improved interior Dri-Fit liner is more comfortable
  - Length: 6.7", Width: 6.25"
- Color Options: **Black, White**  
Size: **XS/S, M/L, XLG/XXL.**

**I378124** Specify Size & Color \$19.99 PR

**NEW!**

**Mizuno TECHNO VOLLEY V L/S JERSEY**

- 88% Mizuno DryLite microfiber polyester with 12% spandex
  - Stretch fabric for greater freedom of movement
  - Revolutionary close-to-the-body design
- Size: **XXS, XSM, SML, MED, LRG, XLG, XXL**  
Color Options: **Black, CARD/WHT, FOR/WHT, Lemon, NAVY/WHT, PURP/WHT, RED/WHT, ROY/WHT, White.**



**MZ440441** Size: **XXS-XXL** \$49.99 EA



**Mizuno LR-6 KNEE PADS**

- Poly/Cotton/Spandex blend
  - VS-I padding in high impact zone
  - 6" sleeve length
  - Low-Rise, No-Fold design
- Color Options: **Black, White.**

**I310153** Medium \$26.99 PR  
**I310160** Large \$26.99 PR



**Mizuno VS-I KNEE PADS**

- Poly/Cotton/Spandex blend
  - VS-I padding for increased Patella, Lateral, and Medial protection
  - 9" sleeve length
- Color Options: **Black, White.**

**MZVBV5IA** Adult - Specify Color \$24.99 PR  
**MZVBV5IJ** Junior - Specify Color \$24.99 PR

**Mizuno VORTEX SHORT**

- 88% Mizuno DryLite micro-fiber polyester with 12% spandex
  - Mizuno "Runbird" logo
  - 4" inseam, Low-rise short
- Size: **XXS, XSM, SML, MED, LRG, XLG, XXL**  
Color Options: **Black, Cardinal, Forest, Navy, Orange, Pink, Purple, Red, Royal.**



**MZ440202** **XXS-2XL** \$24.99 EA



**VOLLEYBALL SCOREBOOK**

- Includes: 24 matches, team roster and simplified instructions.
- NOW INCLUDES RALLY SCORING!!

**I111XXXX** \$7.99 EA



**NEW!**

**Sport Write DRY-ERASE BOARDS**

- Large format enables entire team to see play
- 2 writing surfaces
- Great pen clip with premium dry erase marker

**I383513** 12 1/2"H x 16 1/2"W - 2lbs. \$29.99 EA



**NET SETTER CHAIN**

- Hang from net to measure the correct height of the volleyball net
- 4 pre-set official net heights for Mens, Womens, Co-ed and junior play

**I238778** \$13.99 EA

**VOLLEYBALL ANTENNA**

- White antenna holder is 1" wide complete with velcro strips that secure system to net.
- The antenna slips easily into a pocket for correct positioning on the net.

**VBANT** \$52.99 PR ★

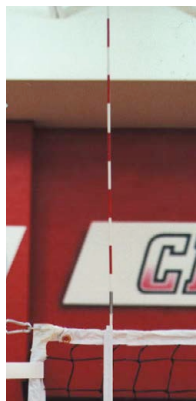

**VOLLEYBALL NET TENSION STRAPS**

- 2" velcro net straps that help secure volleyball net to standards
- Set includes 6 straps

**I203486** \$57.99 SET OF 6 ★

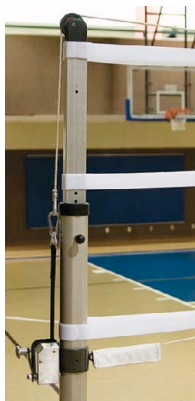

**VOLLEYBALL CABLE PADDING**

- Heavy duty vinyl covered foam padding is split and slips over the top and bottom net cables
- Each pad is 24" long
- Set includes 4 pads

**VBCPAD** White Only \$56.99 SET



## INDOOR TABLETOP SCOREBOARD

- Dimensions: 16"H x 24"W x 10"D - 13 lbs.
- LED clock digits: 4.75", LED score digits: 4.25"
- Scores basketball, volleyball and wrestling and can function as a metronome, stopwatch, clock with alarm and program timer
- Included wireless remote (100' range) allows operator to change score and start/stop the clock
- 4 user-programmable frequency settings for operating multiple units independently in the same area
- Includes digital periods, bonus, team fouls and possession indicators
- Indoor use only
- Optional assembled stand measures 43"H x 28"W x 28"D

SK2229R Indoor Tabletop Scoreboard \$499<sup>22</sup> EA ★

### OPTIONS

I293784	Wheeled Stand	\$99 <sup>22</sup> EA ★
I240597	Extra Loud Horn	\$63 <sup>22</sup> EA ★
I142266	Carry Bag	\$74 <sup>22</sup> EA ★
I201789	Replacement Remote	\$53 <sup>22</sup> EA ★



Built in control panel



## MANUAL SCOREKEEPER WITH ADJUSTABLE STAND

- 7" numbers printed on vinyl
- Scores up to 99 for each team
- Two erasable team panels
- PVC stand measures 38"H with a 15" x 15" base
- Converts from floor model to 12"H table top unit

I162448 \$51<sup>22</sup> EA ★

## MANUAL TABLETOP DOUBLE SIDED SCOREBOARD

- 6" numbers for scoring
- 2.5" numbers to score games (0-5 for each side)
- Scores up to 30 for each team
- Double-sided, see the score from front and back
- Folds up for easy transport and storage

MSMLTSCR 7"H x 15"W \$55<sup>22</sup> EA ★



## PORTABLE MANUAL SCOREKEEPER

- 6" score digits
- 2.5" Period/Games digit up to 5
- Scores game up to 99 for each side
- No assembly required
- Lays flat for storage

I196177 11"H x 23"W \$49<sup>22</sup> EA ★



## MESH BALL CARRIER

- Comes with shoulder strap, vinyl bottom and mesh top fabric

I235654 22"H x 28"W \$32<sup>22</sup> EA ★



## VOLLEYBALL CARRY BAG

- 9" x 50" black polyester with shoulder strap and strong metal zipper
- Holds 6 volleyballs
- Available in Black only

MSVBAGTB \$29<sup>22</sup> EA ★



## E-Z FOLD CART

- Aluminum square frame
- Nylon top with mesh bottom
- Holds 20 basketballs or 30 volleyballs
- Non-marring swivel casters
- Folds to only 6" wide for easy storage

MCVBCARTY 40"H x 24"W x 24"D \$124<sup>22</sup> EA ★





**BEST SELLER**

**NEW AND IMPROVED!**

**ROLLAWAY JUDGES STAND**

- 39" L x 26" W x 80" H
- Constructed of 1.25", silver powder coated steel tubing
- Platform is 27" L x 22" W aluminum diamond plate for traction
- Platform is 44" above floor
- 6" non-marring poly wheels for easy mobility
- Leveling feature for stand for increased stability

**STREFSTD** 60 lbs. \$419<sup>22</sup> EA ★ 



**Judges stand sold separately**

**PADS AVAILABLE IN 5 COLORS**

**BLACK** **DARK GREEN** **NAVY** **ROYAL** **SCARLET**

**JUDGES STAND PAD**

- Protects players from impact collisions
- Constructed of 1.5" thick polyethylene foam covered with 18 oz. fire resistant vinyl
- Official 6' height
- Easy to use hook-and-loop attachments

**1362606** Specify Color \$294<sup>22</sup> EA ★ 



**VOLLEYBALL EQUIPMENT CART**

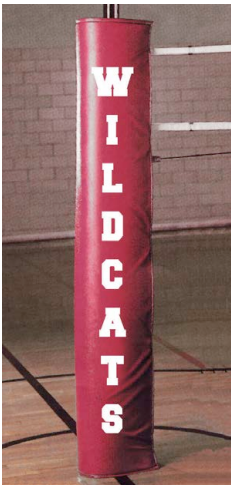

- Constructed 1.5" 14-gauge powder coated steel tubing
- Storage basket is 8" D x 20" W x 5" L
- Transport and store up to 6 poles with other court accessories (balls, nets, pole pads, etc.)
- Includes 4 non-marring swivel casters
- 60" L x 32" W x 42" H

**1197372** 60 lbs. \$384<sup>22</sup> EA ★



**STANDARD PADS WITH LETTERING**

- Heavy duty 14 oz. reinforced vinyl
- Fits poles 3" O.D. or larger
- Pad is 72"H x 2" thick foam
- Includes hook-and-loop fasteners
- Add up to (8) 8" letters to your post pads
- Lettering will be one-color or two-color block style print
- Please specify color

1376738 2-color \$849<sup>22</sup> PR ★   
 1376737 1-color \$649<sup>22</sup> PR ★ 



**STANDARD PAD**

- Heavy duty 14 oz. reinforced vinyl covered Ethafoam
- Fits poles 3" O.D. or larger
- Pad is 72"H x 2" thick foam
- Includes hook-and-loop fasteners

**1012392** Royal Blue \$349<sup>22</sup> PR ★   
**1203509** Specify Color \$369<sup>22</sup> PR ★ 

**PADS AVAILABLE IN 5 COLORS**

**BLACK** **DARK GREEN** **NAVY** **ROYAL** **SCARLET**

## POWER STANDARDS (Floor Plate Required)



### 1. POWER PLAY GAME STANDARD

- 24" heavy wall steel base, with non-marring rubber floor protectors, non-marring wheels, and blue powder coated finish
- 2-3/8" heavy wall galvanized steel uprights with pre-set heights to play men's and women's volleyball, badminton, and tennis
- Includes: 2 safety padded guy wires, 2 floor plate anchors with hand bolts, 2 pulleys and a safety precision worm gear winch
- Designed for competitive play
- Recommended net - SNVBSC32Y
- **Requires floor anchoring.**

**ST240PWR** 110 lbs. - Pair \$699<sup>22</sup> PR ★

### 2. POWER PLAY CENTER STANDARD

- Use with Power Play Game Standards (ST240PWR) for side by side court play
- Same Specifications as the ST240PWR
- Includes winch

**ST240PCS** 63 lbs. \$399<sup>22</sup> EA ★



#### WORM GEAR STRAP WINCH

- Powder coated housing with stainless steel cover
- Low profile handle does not require removal
- Tension strap eliminates cable kinking
- Universal bolt pattern, designed to use with Power Play Game Standard

**ZWORMGEARX**

\$139<sup>22</sup> EA ★



## HEAVYWEIGHT STANDARDS (Recommended for P.E.)



### 3. 24" MULTI-GAME STANDARD

- 24" heavy wall steel base, with non-marring rubber floor protectors, non-marring wheels, and blue powder coated finish
- 2-3/8" heavy wall galvanized steel uprights with pre-set heights to play men's and women's volleyball, badminton, and tennis
- Designed for recreational play
- Recommended net - SNVBRC32
- **Weighted base does not require floor anchoring**

**ST240S/P** 360 lbs. - Pair \$779<sup>22</sup> PR ★

### 24" MULTI-GAME CENTER STANDARD

- Use with Multi-Game Standards (ST240S/P) for side-by-side court play
- Same specifications as ST240S/P

**ST240C/S** 180 lbs. \$449<sup>22</sup> EA ★

### 4. 30" MULTI-GAME STANDARD

- Heavy weighted base does not require floor anchor
- 30" heavy wall steel base with non-marring rubber floor protectors, non-marring wheels, and blue powder-coated finish
- Pole is 10' high, made of heavy wall galvanized tubing.

**VBBASE30** 500 lbs. - Pair \$999<sup>22</sup> PR



### STANDARD POLE PAD

- Fits poles 3" O.D. or smaller
- 6'H with 2" thick vinyl covered foam and hook and loop fasteners
- Not intended for in-ground outdoor volleyball poles

**I012415** Royal Blue Only \$224<sup>22</sup> PR ★

### CENTER POLE PAD

- Pad for the Power Play Center Standard (ST240PCS)

**MSVBPADC** Royal Blue Only \$159<sup>22</sup> EA ★



### PROTECTIVE BASE PAD

- Vinyl covered bonded foam
- Easy to install with hook-and-loop attachments
- Blue only

**I012385** \$109<sup>22</sup> EA ★  
**I193572** 30" Diameter \$157<sup>22</sup> EA



### MULTI-USE STANDARDS

- 24" diameter heavy wall steel base with non-marring rubber rim and 10"H base stem, Pole height: 8'
- 1 3/4" O.D. steel upright with 2 single ring slides for net attachment
- Available in 3 sizes
- Designed for indoor or outdoor use
- Color Options: **Black, Blue, Green, Red, White, Yellow.**

**I309294** 130 lbs. \$399<sup>22</sup> EA   
**I309355** 180 lbs. \$439<sup>22</sup> EA   
**I309416** 220 lbs. \$479<sup>22</sup> EA

### OUTDOOR VOLLEYBALL PACKAGES

- 10'H x 2 3/8" O.D. galvanized steel pole inserts 2' into ground sleeves or can be permanently installed in concrete
- Pre-Drilled for volleyball, badminton and tennis
- All weather treated net secures through eye bolts

<b>VBPK1</b>	Steel Top Cable Net - PVC Ground Sleeves/No Cap	\$409 <sup>22</sup> SET	★ <b>SALE!</b>
<b>VBPK2</b>	Steel Top Cable Net/Steel Ground Sleeves/With Cap	\$524 <sup>22</sup> SET	★ <b>SALE!</b>
<b>VBPK3</b>	Rope Top Cable Net/PVC Ground Sleeves/No Cap	\$379 <sup>22</sup> SET	★ <b>SALE!</b>
<b>VBPK4</b>	Rope Top Cable Net/Steel Ground Sleeves/With Cap	\$494 <sup>22</sup> SET	★ <b>SALE!</b>

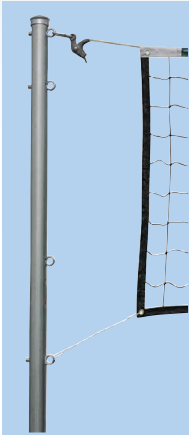

**PVC with No Cap**

**Galvanized Steel with Wrench Cap**

Rope cable net system (Shown on left) utilizes galvanized steel rope cleats for easy net attachment.



**ALL PACKS INCLUDE 6 FREE SOFT SHOT VOLLEYBALLS!**

**Steel cable net system (Shown on right) includes heavy duty steel ratchet with removable handle.**

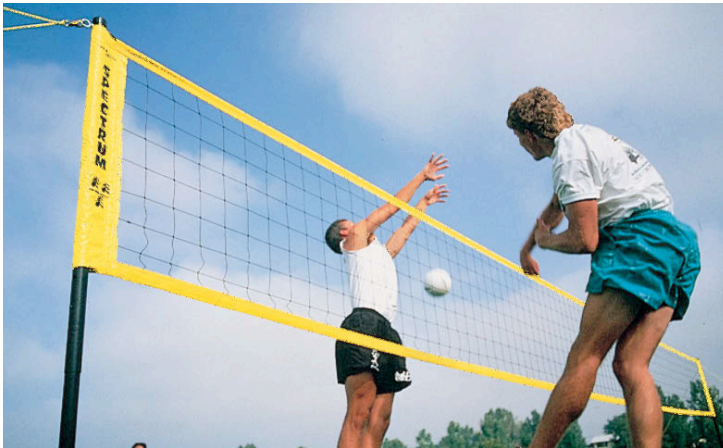
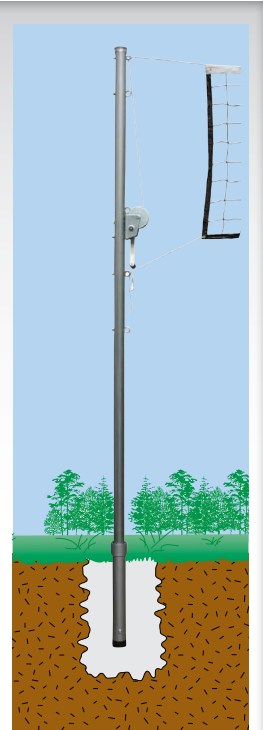

### SPECTRUM 2000 VOLLEYBALL SYSTEM

- Quick set up and completely portable
  - Aluminum standards have push button locks for easy height adjustment
  - Set includes: 1 3/4" telescopic 2-piece aluminum poles, 3' x 32' sleeve net, 1/4" pull-down guyline system, 10" steel stakes, pre-measured boundary w/corner anchors, winder and storage bag
- 15 Year Limited Warranty**

60790XXX \$329<sup>22</sup> SET



### PLAYER III™ VOLLEYBALL SYSTEM

PERFECT FOR RECREATIONAL PLAY

- Set up is quick and easy
- Set includes: 1-7/8" telescopic, 3-piece PVC poles, 3' x 32' net w/slip on straps, 3/16" triple guylines w/tension rings, 10" ABS ground stakes, pre-measured boundary and storage bag

2002111 \$147<sup>22</sup> SET

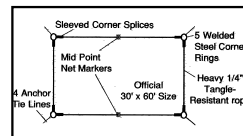

**MARK YOUR COURT WHEREVER YOU PLAY!**

### VOLLEYBALL BOUNDARY MARKERS

- 1/4" heavy-duty polypropylene rope with mid-point net markers, splice protector corner sleeves, nickel-plated corner rings
- Official 30' x 60' court size
- Includes storage winder

90355YLX Yellow Only \$59<sup>22</sup> EA ★



## High School/Collegiate Wrestling Mats

Our wrestling mats are manufactured to meet NCAA specifications. Constructed with lightweight, crack-proof, anti-bacterial/anti-fungal materials, these mats feature durable vinyl PVC outer that is bonded to the foam core. Standard price includes: Single color mat w/ 10' diameter center circle and outer boundary circle, reverse side has 9 practice circles

### ADDITIONAL FEATURES:

- Dense, 1" or 1-1/4" thick shock absorbing mat
- Tough poly-vinyl #457 coating
- No cross-seams in official wrestling area
- Ensolite AAC foam core as used for the NCAA Championships
- Multi-colors, customized insignias & lettering available at additional charge
- **26 color choices:** White, Light Grey, Grey, Metallic Silver, Black, Pale Yellow, Light Gold, Metallic Gold, Old Gold, Kelly Green, Medium Green, Dark Green, Red, Orange, Burnt Orange, Light Maroon, Dark Maroon, Chocolate Brown, Turquoise, Sea Green, Columbia Blue, Bright Blue, Royal Blue, Penn State Blue, Navy Blue, Purple
- Mats may be divided into multiple sections for easy handling **NCAA rules require a mat size of 42' x 42' with a minimum wrestling circle of 32'. High School regulation size is 38' x 38' with a minimum 28' wrestling circle.**

6426XXXX 1" Thick Material \$8<sup>22</sup> SQ.FT.   
 6428XXXX 1-1/4" Thick Material \$9<sup>22</sup> SQ.FT. 

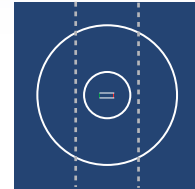
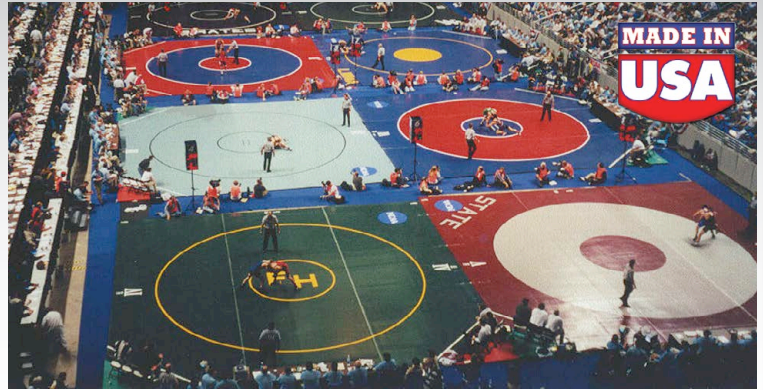

Standard Layout

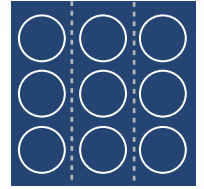

Practice Circles



## WRESTLING SCOREBOOK

- Includes NCAA and international wrestling sheets, dual meets, 17 weight classes, tournaments, season summaries, and more.

1420392 \$7<sup>22</sup> EA

## INDOOR TABLETOP SCOREBOARD

- Dimensions: 16"H x 24"W x 10"D - 13 lbs.
- LED clock digits: 4.75", LED score digits: 4.25"
- Scores basketball, volleyball and wrestling and can function as a metronome, stopwatch, clock with alarm and program timer
- Included wireless remote (100' range) allows operator to change score and start/stop the clock
- 4 user-programmable frequency settings for operating multiple units independently in the same area
- Includes digital periods, bonus, team fouls and possession indicators
- Indoor use only
- Optional assembled stand measures 43"H x 28"W x 28"D

SK2229R Indoor Tabletop Scoreboard \$499<sup>22</sup> EA ★



## QUAD III HEADGEAR

- Adjustable 5-strap system offers maximum support
- Soft polymer shell holds EVA pads for optimized comfort
- **Minimum order of 10ea**
- Colors: **White/Red, White/Royal, Red/Black, Royal/Black, Black/Grey, Black/Orange, Navy/Gold, Royal/Gold, Black/Gold**

1274240 One Size Fits All \$29<sup>22</sup> EA



## TORNADO F5 HEADGEAR

- It's 43% lighter, remarkably cooler and includes a greater audible sound technology.
  - Incorporates our Power Tab strapping system for a better, faster fit.
  - Combats bacterial build-up.
- Color Options: **Black, Dark Green, Maroon, Royal.**

1420147 One Size Fits All \$35<sup>22</sup> EA



## ANKLE BANDS

- Made from soft vinyl that wraps around and fastens with velcro®.
- Easy to put on, take off. Washable and will not shrink or stretch out.

1406285 4 bands per set-2 Red/2 Green \$9<sup>22</sup> EA



## SIGNATURE® E58 HEADGEAR

- Signature™ 4-strap FOAM headgear
- Lightweight, comfortable fit, fully adjustable
- Can be adjusted to youth sizes
- SP94 chin strap pad included.

Color Options: **Black, Dark Green, Light Gold, Maroon, Navy, Orange, Purple, Royal, Scarlet, Silver Grey, Vegas Gold, White.**

1242508 One Size Fits All \$32<sup>22</sup> EA



## MAT TAPE

- Easy to use and remove
- Will not stretch out
- Secures overlaps

6411XXXX 3" x 84' \$13<sup>22</sup> ROLL ★  
 6406XXXX 4" x 84' \$14<sup>22</sup> ROLL ★



## GORILLA GRIP™ MAT TAPE

- Specifically designed adhesive that gives powerful grip to your mat
- Leaves no gummy residue
- Reuseable many times, each roll individually wrapped
- 8 mils thick, Color: Transparent

1406240 3" x 84' \$14<sup>22</sup> ROLL  
 1406245 4" x 84' \$17<sup>22</sup> ROLL





**CHAMPION BARBELL.**

**OLYMPIC STYLE BARS**

- All bars are made of high-tensile chrome-molybdenum steel
- All bars have bronze bushings for smooth sleeve rotation and no end screws
- I101247 features special center knurling, made especially for power lifters
- Weights should always be removed from bar when not in use
- All bars carry a 10 year limited warranty

1. I101247	86" Zinc Plated - 1500 lb. Capacity	\$274 <sup>22</sup> EA ★
2. I101248	86" Black Oxide - 1500 lb. Capacity	\$289 <sup>22</sup> EA ★
3. I101249	86" Black Zinc with Chrome Sleeves - 1000 lb. Capacity	\$219 <sup>22</sup> EA ★
4. CHCOB760	60" Chrome Plated - 700 lb. Capacity	\$159 <sup>22</sup> EA ★
5. I101250	72" Aluminum Technique Bar - 200 lb. Capacity	\$179 <sup>22</sup> EA ★
6. CHCOCBXX	47" E-Z Curl Bar with Collars	\$109 <sup>22</sup> EA ★
7. CHSNPXXX	Bar Wrap Pad	\$16 <sup>22</sup> EA ★

**WEIGHT LIFTING CHAINS**

- Helps zero-out momentum near lockout for a more effective lift
- Each link provides consistent and accumulated resistance as it's lifted
- Each chain is 60"L with black powder coated bar collars

1326383	1/2" - 22 lb.	\$159 <sup>22</sup> PR
1326390	5/8" - 32 lb.	\$179 <sup>22</sup> PR
1326406	3/4" - 52 lb.	\$229 <sup>22</sup> PR

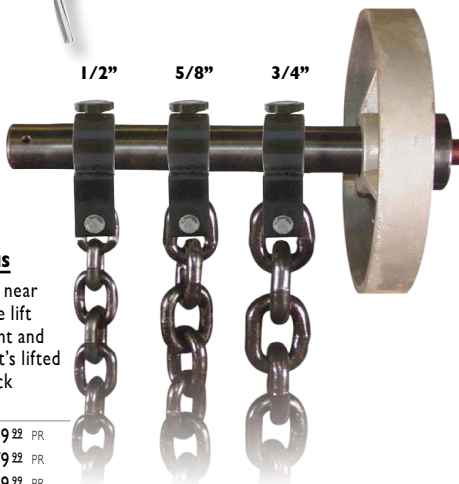

**SUPER BANDS**

- Bands add resistance to lifting exercises without increasing weight, can also be used for assisted pull-ups and dips
- Bands also maximize stretching, rehabilitation, and speed training
- All bands are 41"L and 3/8" thick; width varies with level of resistance
- Made of super strong seamless latex rubber

1333541	XXLight (5-35 lbs.) Red	\$18 <sup>22</sup> EA
1333558	XLight (10-50 lbs.) Black	\$27 <sup>22</sup> EA
1333565	Light (25-80 lbs.) Purple	\$36 <sup>22</sup> EA
1333572	Medium (50-120 lbs.) Green	\$42 <sup>22</sup> EA
1333589	Heavy (60-150 lbs.) Blue	\$50 <sup>22</sup> EA
1333596	XHeavy (70-175 lbs.) Orange	\$70 <sup>22</sup> EA
1333602	XXHeavy (80-200 lbs.) Grey	\$89 <sup>22</sup> EA



**CHAMPION BARBELL.**  
**OLYMPIC TRAP BAR**

- Constructed of 1" chrome stock
- Bar is 56"L and 29"W
- For use with Olympic-style plates
- Weight plates and collars sold separately (See page 247)

CHTRAPXX

\$245<sup>22</sup> EA

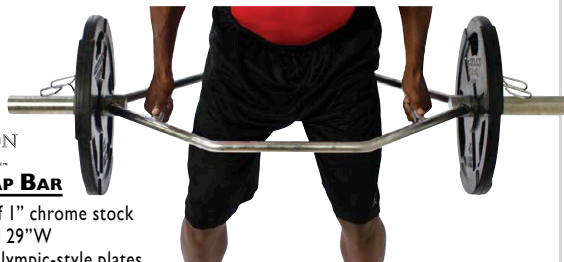

**CHAMPION BARBELL.**  
**OLYMPIC-STYLE TRICEP BOMBER**

- Constructed of 1" chrome stock
- For use with Olympic-style plates
- Includes wrenchless collars
- Weight plates sold separately (See page 247)

CHTRICOL

\$129<sup>22</sup> EA ★



**MUSCLE CLAMP**

- High pressure locking system
- Locks into place with a single motion
- Constructed of durable nylon
- For use with Olympic bars

Color Options: **Black, Blue, Red.**

I250060

Specify Color

\$45<sup>22</sup> PR



**LOCK-JAW COLLAR**

- Solid nylon injection molded frame and injection molded pads
- Single-action cam lock securely clamps the collar to the bar
- For use with Olympic bars

I379947

Black Only

\$38<sup>22</sup> PR



**CHROME SPRING COLLAR**

- For use with Olympic bars

I015911

\$12<sup>22</sup> PR ★



**CHAMPION BARBELL.**  
**VERTICAL OLYMPIC BAR HOLDER**

- Holds 8 Olympic style bars securely in a minimal amount of space
- Horns have nylon sleeves to protect bars
- 16" diameter x 3/4" solid steel base with black powder coated finish

20028055

42 lbs.

\$149<sup>22</sup> EA ★



**CHAMPION BARBELL.**  
**WRIST ROLLER**

- Improves wrist, forearm and grip strength
- For use with standard (1" hole diameter) or Olympic (2" hole diameter) plates
- Weight plate sold separately (See page 247)

CHCWRXXX

\$29<sup>22</sup> EA



**CHAMPION BARBELL.**

### OLYMPIC GRIP PLATES

• All plates have a durable, grey hammertone, acrylic finish

<b>1272475</b>	2.5 lb.	\$4 <sup>99</sup> EA ★	<b>1272512</b>	35 lb.	\$49 <sup>99</sup> EA ★
<b>1272482</b>	5 lb.	\$8 <sup>99</sup> EA ★	<b>1272529</b>	45 lb.	\$65 <sup>99</sup> EA ★
<b>1272499</b>	10 lb.	\$15 <sup>99</sup> EA ★	<b>1272536</b>	100 lb.	\$149 <sup>99</sup> EA ★ <b>S&amp;H</b>
<b>1272505</b>	25 lb.	\$38 <sup>99</sup> EA ★			



**CHAMPION BARBELL.**

### RUBBER COATED OLYMPIC GRIP PLATE

- Will not crack, chip, flake, peel, rust or tear like painted cast iron plates
- Prevents damage to floors, upholstery and will not dent or scratch equipment
- Reduces weight room noise
- Set includes: 1000 lb. capacity Olympic bar, 2 each 45 lb, 35 lb, 25 lb, 10 lb, 2.5 lb, 4 each 5 lb rubber coated grip plates and a pair of 2" Muscle Clamps (Black)

<b>1272550</b>	2.5 lb.	\$6 <sup>99</sup> EA ★	<b>1272581</b>	25 lb.	\$54 <sup>99</sup> EA ★
<b>1272567</b>	5 lb.	\$12 <sup>99</sup> EA ★	<b>1272598</b>	35 lb.	\$74 <sup>99</sup> EA ★
<b>1272574</b>	10 lb.	\$23 <sup>99</sup> EA ★	<b>1272604</b>	45 lb.	\$94 <sup>99</sup> EA ★

### 300 lb. set with 1000 lb. Capacity Bar

**1256574** \$769<sup>99</sup> SET ★ **S&H**

**CHAMPION BARBELL.**

### OLYMPIC WEIGHT SETS

All sets include:

- 28.5mm (1.12") diameter grip x 2.2m (86.6") long Olympic bar made to AAU/IWF specifications with 50mm (1.96") diameter sleeves
- Bronze bushings for smooth sleeve rotation
- Olympic grip plates with grey hammertone, acrylic finish
- One pair of chrome spring collars



### Economy 300 Lb. Weight Set

- Includes 700 lb. capacity chrome bar and spring collars
- 14 Olympic grip plates - 2/45's, 2/35's, 2/25's, 2/10's, 4/5's, 2/2.5's

**1035636**

\$449<sup>99</sup> SET ★ **S&H**

### 300 Lb. Standard Weight Set

- Includes 1000 lb. capacity black zinc bar with chrome sleeves and spring collars
- 14 Olympic grip plates - 2/45's, 2/35's, 2/25's, 2/10's, 4/5's, 2/2.5's

**WSETS310**

\$529<sup>99</sup> SET ★ **S&H**

### 300 Lb. Deluxe Weight Set

- Includes 1500 lb. capacity black oxide bar and spring collars
- 14 Olympic grip plates - 2/45's, 2/35's, 2/25's, 2/10's, 4/5's, 2/2.5's

**CHCOS310**

\$639<sup>99</sup> SET ★ **S&H**

### 400 Lb. Olympic Set

- Includes 1500 lb. capacity black oxide bar and spring collars
- 18 Olympic grip plates - 4/45's, 2/35's, 2/25's, 2/10's, 6/5's, 2/2.5's

**CHCOS400**

\$739<sup>99</sup> SET ★ **S&H**

### 500 Lb. Olympic Weight Set

- Includes 1500 lb. capacity black oxide bar and spring collars
- 22 Olympic grip plates - 6/45's, 2/35's, 2/25's, 2/10's, 8/5's, 2/2.5's

**CHCOS500**

\$839<sup>99</sup> SET ★ **S&H**



**NEW!**

## PowerMax

### BLACK RUBBER BUMPER PLATES

- Designed to impact the ground without creating damage to the floor
- 100% virgin rubber with solid steel insert
- For use with Olympic-style bars
- Sold in pairs

<b>1388429</b>	10 lb.	\$99 <sup>99</sup> PR
<b>1375514</b>	15 lb.	\$119 <sup>99</sup> PR
<b>1388430</b>	25 lb.	\$129 <sup>99</sup> PR
<b>1388431</b>	35 lb.	\$189 <sup>99</sup> PR
<b>1388432</b>	45 lb.	\$229 <sup>99</sup> PR



## PowerMax

### COLOR RUBBER BUMPER PLATES

- Designed to impact the ground without creating damage to the floor
- 100% virgin rubber with solid steel insert
- For use with Olympic-style bars
- Sold in pairs

<b>1375513</b>	10 lb. - Green	\$149 <sup>99</sup> PR
<b>1375515</b>	25 lb. - Yellow	\$259 <sup>99</sup> PR
<b>1375516</b>	35 lb. - Blue	\$309 <sup>99</sup> PR
<b>1375517</b>	45 lb. - Red	\$389 <sup>99</sup> PR



**REACTOR**

CHAMPION BARBELL.

### LAND MINE TRAINER

- Made of heavy-duty 11 gauge black powder coated steel
- Perform dynamic movements and exercises simply by inserting any Olympic-size bar (not included) into the 10" pivoting sleeve
- 5" lower tube inserts into any standard Olympic plate to create an anchor/base

**1377173**

\$79<sup>99</sup> EA

**CHAMPION BARBELL.**

### OLYMPIC VERTICAL PLATE HOLDER

- 6 post Olympic plate holder with protective sleeves and rubber bump stops
- Durable textured, silver powder coated finish
- 4'H x 18"W x 18"D - 72 lbs.

**1076097** \$167<sup>99</sup> EA ★



**CHAMPION BARBELL.**

### OLYMPIC BAR AND PLATE HOLDER

- 6 plate posts with protective end caps
- 6 bar holders with nylon sleeves to protect bars
- Silver powder coated finish
- 44"H x 20"W x 29"L - 55 lbs.

**1366837**

\$178<sup>99</sup> EA ★



**CHAMPION BARBELL.**

### OLYMPIC STYLE PLATE HOLDER

- 6 post Olympic plate holder with durable textured, silver powder coated finish
- 3'H x 18"W x 3'D - 32 lbs.

**01810000**

\$125<sup>99</sup> EA ★



**CHAMPION BARBELL** *WEIGHT LIFTING BELTS*

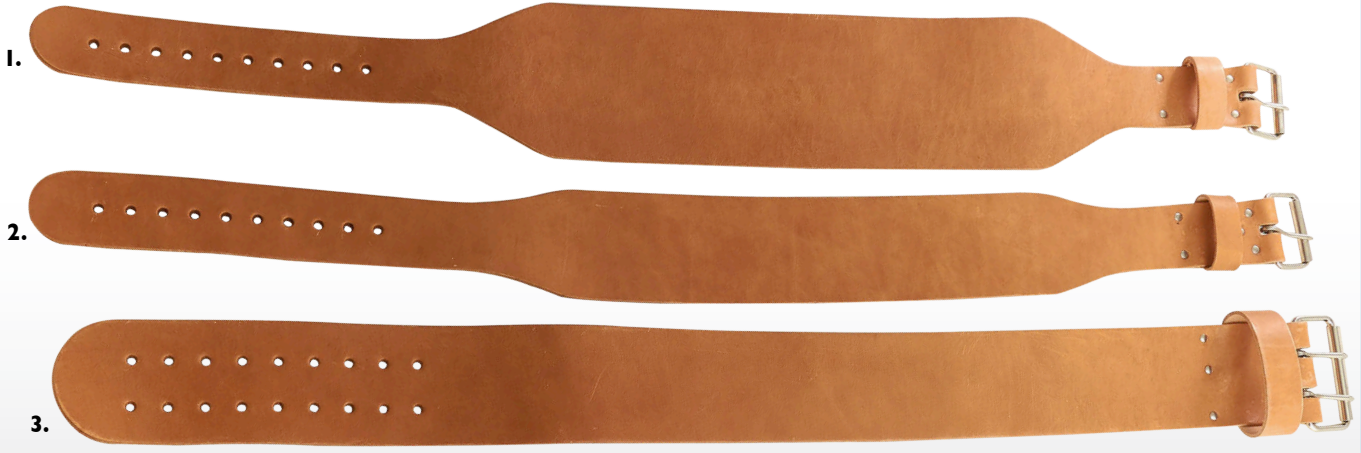

**1. 6" WIDE TAPERED TRAINING BELT**

- Single prong buckle
- Natural finish, high quality cowhide
- Does not meet competition regulations
- Specify size: S (27-36"), M (31-40"), L (35-44"), XL (39-48"), XXL (43-52")

<b>CHCTB</b>	S-L	\$47 <sup>22</sup> EA ★
<b>CHCTBXLX</b>	XL	\$53 <sup>22</sup> EA ★
<b>CHCTBXXL</b>	XXL	\$57 <sup>22</sup> EA ★

**2. 4" WIDE TAPERED REGULATION BELT**

- Single prong buckle
- Natural finish, high quality cowhide
- Specify size: S (27-36"), M (31-40"), L (35-44"), XL (39-48"), XXL (43-52")

<b>CHCLB</b>	S-L	\$38 <sup>22</sup> EA ★
<b>CHCLBXLX</b>	XL	\$44 <sup>22</sup> EA ★
<b>CHCLBXXL</b>	XXL	\$48 <sup>22</sup> EA ★

**3. 10CM WIDE OFFICIAL WEIGHT BELT**

- Two prong buckle
- Natural finish, high quality cowhide
- Lifting belt without taper
- Specify size: S (27-36"), M (31-40"), L (35-44"), XL (39-48"), XXL (43-52")

<b>CHOLB</b>	S-L	\$53 <sup>22</sup> EA ★
<b>CHOLBXLX</b>	XL	\$59 <sup>22</sup> EA ★
<b>CHOLBXXL</b>	XXL	\$63 <sup>22</sup> EA ★



**4" LIFTING BELT BLACK**

- Made from top quality cowhide
- Built-in foam lumbar pad and soft suede lining
- Sturdy double-stitched edges and two-prong roller buckle for secure fit
- Available in black only
- Size: 24-30" **SM**, 31-37" **MD**, 38-45" **LG**, 44-51" **XL**.

**I240108** Specify Size \$26<sup>22</sup> EA



**NYLON LIFTING BELT**

- Nylon belt with patented One-way Velcro® closure
- Patented downward angle fits the natural shape of your back
- Specify Color: Black, Green, Navy, Red, Royal or Purple
- Specify Size: XS (24"-28"), S (27"- 32"), M (31"- 36"), L (35"- 41"), XL (40"- 45"), XXL (44"- 50")

<b>CH2004XX</b>	4 3/4"	\$66 <sup>22</sup> EA
<b>CH2006XX</b>	6"	\$69 <sup>22</sup> EA



**WALL-MOUNTED BELT RACK**

- All steel wall-mounted unit features five 10" long pegs for storage
- 25" long unit attaches to wall to save space
- Mounting hardware not included

**MSWWMJRCBM** \$44<sup>22</sup> EA ★



**GYM CHALK**

- For weight-lifting or gymnastics
- Conveniently wrapped in 2 oz. blocks
- Eight blocks per 1 lb. package

**PGE4360X** \$15<sup>22</sup> LB ★



**WEIGHT GLOVES**

- Soft terry lining for comfort and durability
- Padded leather palms with reinforced stitching
- Hook & loop closure tabs
- Size: **SML, MED, LRG, XLG, 2XL**.

**I364701** Specify Size \$14<sup>22</sup> PR



**LIFTING STRAPS**

- Removes pressure from hands to allow for greater lifting ability
- High quality 1 1/2" heavy cotton web construction
- One size fits all

**I273731** \$13<sup>22</sup> PR



CHAMPION BARBELL.

### SOLID HEX DUMBBELLS

- Solid cast iron with durable, grey hammer tone, acrylic finish
- Straight handles with deep set knurling for functional performance
- Now sold as each, not pairs

1152051	3 lb.	\$3 <sup>99</sup> EA ★	1152062	55 lb.	\$69 <sup>99</sup> EA ★
1152052	5 lb.	\$6 <sup>99</sup> EA ★	1152063	60 lb.	\$76 <sup>99</sup> EA ★
1152053	10 lb.	\$12 <sup>99</sup> EA ★	1152064	65 lb.	\$83 <sup>99</sup> EA ★
1152054	15 lb.	\$19 <sup>99</sup> EA ★	1152065	70 lb.	\$89 <sup>99</sup> EA ★
1152055	20 lb.	\$25 <sup>99</sup> EA ★	1152066	75 lb.	\$94 <sup>99</sup> EA ★
1152056	25 lb.	\$32 <sup>99</sup> EA ★	1152067	80 lb.	\$99 <sup>99</sup> EA ★
1152057	30 lb.	\$39 <sup>99</sup> EA ★	1152068	85 lb.	\$107 <sup>99</sup> EA ★ <b>S&amp;H</b>
1152058	35 lb.	\$45 <sup>99</sup> EA ★	1152069	90 lb.	\$115 <sup>99</sup> EA ★ <b>S&amp;H</b>
1152059	40 lb.	\$51 <sup>99</sup> EA ★	1152070	95 lb.	\$122 <sup>99</sup> EA ★ <b>S&amp;H</b>
1152060	45 lb.	\$58 <sup>99</sup> EA ★	1152071	100 lb.	\$135 <sup>99</sup> EA ★ <b>S&amp;H</b>
1152061	50 lb.	\$64 <sup>99</sup> EA ★			



CHAMPION BARBELL.

### RUBBER ENCASED SOLID HEX DUMBBELLS

- Permanently attached cast iron heads are encased in maintenance free virgin rubber
- Ergonomically designed solid steel handle for comfort and safety
- Handles are knurled and chrome plated; will not peel or chip

1347753	3 lb.	\$11 <sup>99</sup> EA ★	1347876	55 lb.	\$100 <sup>99</sup> EA ★
1347760	5 lb.	\$15 <sup>99</sup> EA ★	1347883	60 lb.	\$110 <sup>99</sup> EA ★
1347777	10 lb.	\$24 <sup>99</sup> EA ★	1347890	65 lb.	\$115 <sup>99</sup> EA ★
1347784	15 lb.	\$32 <sup>99</sup> EA ★	1347906	70 lb.	\$130 <sup>99</sup> EA ★
1347791	20 lb.	\$39 <sup>99</sup> EA ★	1347913	75 lb.	\$135 <sup>99</sup> EA ★
1347807	25 lb.	\$46 <sup>99</sup> EA ★	1347920	80 lb.	\$145 <sup>99</sup> EA ★
1347814	30 lb.	\$52 <sup>99</sup> EA ★	1347937	85 lb.	\$155 <sup>99</sup> EA ★ <b>S&amp;H</b>
1347821	35 lb.	\$63 <sup>99</sup> EA ★	1347944	90 lb.	\$165 <sup>99</sup> EA ★ <b>S&amp;H</b>
1347838	40 lb.	\$75 <sup>99</sup> EA ★	1347951	95 lb.	\$170 <sup>99</sup> EA ★ <b>S&amp;H</b>
1347845	45 lb.	\$78 <sup>99</sup> EA ★	1347968	100 lb.	\$180 <sup>99</sup> EA ★ <b>S&amp;H</b>
1347869	50 lb.	\$90 <sup>99</sup> EA ★			



CHAMPION BARBELL.

### ADJUSTABLE DUMBBELL RACKS

- Cradle width is adjustable during assembly to accommodate an inside handle length between 4 1/2" and 5 3/8"
- Cradles are black UHMW polyethylene
- 2" x 3" 11-gauge steel frame construction with silver powder coated finish
- Dumbbells not included

01811500	9 Pair Rack - 36"H x 24"D x 52"L	\$359 <sup>99</sup> EA ★ <b>S&amp;H</b>
811100	12 Pair Rack - 36"H x 24"D x 70"L	\$399 <sup>99</sup> EA ★ <b>S&amp;H</b>



### NEOPRENE DUMBBELL SET

- Neoprene coated dumbbells and sturdy steel rack with locking top pin
- Heavy duty casters for easy rolling and storage
- Complete set includes 95 dumbbells: 16 - 1lb, 12 - 2lb, 10 - 3lb, 10 - 4lb, 9 - 5lb, 8 - 6lb, 8 - 7lb, 8 - 8lb, 7 - 9 lb, 7 - 10lb

1257571	Complete Set	\$1,154 <sup>99</sup> EA <b>S&amp;H</b>
1300130	Rack only w/o wheels	\$224 <sup>99</sup> EA <b>S&amp;H</b>
1300147	Optional wheel package for rack	\$114 <sup>99</sup> EA

CHAMPION BARBELL.

### UPRIGHT DUMBBELL STORAGE RACKS

- Space saving design with maximum storage capacity
- Accommodates most styles of dumbbells
- 42" High with 9" X 19" base
- Dumbbells not included

1137563	2-Sided - Holds 8 Pair	\$188 <sup>99</sup> EA ★
1137574	4-Sided - Holds 13 Pair	\$267 <sup>99</sup> EA ★



### NEOPRENE DUMBBELLS

- Cast iron core coated with durable, thick, easy to clean neoprene
- Multiple colors, perfect for gym, classroom and home use

1291902	1 lb. - Lavender	\$1 <sup>99</sup> EA	1291957	6 lb. - Green	\$10 <sup>99</sup> EA
1291919	2 lb. - Pink	\$3 <sup>99</sup> EA	1291964	7 lb. - Teal	\$12 <sup>99</sup> EA
1291926	3 lb. - Magenta	\$5 <sup>99</sup> EA	1291971	8 lb. - Orange	\$14 <sup>99</sup> EA
1291933	4 lb. - Purple	\$7 <sup>99</sup> EA	1291988	9 lb. - Red	\$16 <sup>99</sup> EA
1291940	5 lb. - Lime	\$8 <sup>99</sup> EA	1291995	10 lb. - Blue	\$18 <sup>99</sup> EA



CHAMPION  
BARBELL.

### WHEELED MULTI-BENCH

- 7 adjustments from 10 degrees decline to 80 degrees incline
- 5 seat height adjustments
- Constructed of 2" x 3" heavy wall steel tubing
- Pads are 2.5" high density foam with Black marine grade vinyl
- 20"H x 23"W x 54"D - 100 lbs.

815102  
813702

No Spotter's Platform  
With Spotter's Platform

\$459<sup>22</sup> EA ★   
\$499<sup>22</sup> EA ★



CHAMPION  
BARBELL.

### MULTI-BENCH

- Adjusts to decline, flat or incline positions
- Constructed of 2" x 3" heavy wall steel tubing
- Pads constructed of 2.5" high density foam with Black marine grade vinyl
- Padded leg support for added stability
- 20.5"H x 26"W x 62.5"D - 68 lbs.

601102

\$299<sup>22</sup> EA ★



CHAMPION  
BARBELL.

### ADJUSTABLE CURL BENCH

- Constructed of 2" x 3" heavy wall steel tubing
- Fully adjustable arm pad to accommodate different sized users
- Pads are 2.5" high density foam covered in Black marine grade vinyl
- 32.5"H x 28"W x 41"D - 63 lbs.

600200

\$249<sup>22</sup> EA ★



CHAMPION  
BARBELL.

### FLAT BENCH

- Great for dumbbell flies, rows, pullovers and tricep extensions
- Constructed of 2" x 3" heavy wall steel tubing
- Pads are 2.5" high density foam with Black marine grade vinyl
- Includes wheels for mobility
- 19.5"H x 21"W x 51.5"D - 50 lbs.

600902

\$189<sup>22</sup> EA ★



CHAMPION  
BARBELL.

### ADJUSTABLE INCLINE BENCH WITH SPOTTERS PLATFORM

- Constructed of 2" square heavy wall steel tubing
- Ideal for developing deltoids and upper pectorals
- Pad is 10"W x 42"L and adjusts from 36° to 56° and is constructed of 2.5" high density foam with 40 oz. Black marine grade vinyl
- Includes spotter's platform
- 45"H x 48"W x 48"D - 140 lbs.

812702

\$469<sup>22</sup> EA ★



CHAMPION  
BARBELL.

### FIELD HOUSE COMPETITION BENCH

- Constructed of 3" x 3" and 2" x 3" heavy wall steel tubing for maximum stability with heavy weights
- Pad is constructed of 2.5" high-density foam with 40 oz. Black marine grade vinyl
- Equipped with lower safety bar rests
- 44"H x 49"W x 52"D - 120 lbs.

814402

\$399<sup>22</sup> EA ★



CHAMPION  
BARBELL.

### STANDARD BENCH PRESS

- Constructed of 1.5" square heavy wall steel tubing
- Pad is constructed of 2.5" high density foam covered in 40 oz. Black marine grade vinyl
- Equipped with lower safety bar rests
- 44"H x 45"W x 48"D - 72 lbs.

814002

\$259<sup>22</sup> EA ★



J-Hook Bar Catch



Resistance Band Attachments



## POWER RACKS

- Constructed of 3" x 3" and 2" x 3" heavy wall silver powder coated steel tubing
- 10 weight storage horns with protective wear sleeves and rubber bump stops
- Easily adjustable J-Hook bar catches and safeties with UHMW polyethylene bar guards
- Includes a multi-grip pull up bar and multiple resistance band attachments
- Double Half Rack includes 2 bar storage holders
- Full Power Rack: 96"H x 48"W x 80"D - 460 lbs.
- Double Half Rack: 96"H x 48"W x 91"D - 606 lbs.
- Half Rack: 96"H x 48"W x 57"D - 368 lbs.
- Power lift platform is 8' x 8' with a steel frame and 3/4" rubber top
- A 1 1/2" plywood sub floor consisting of 4 sheets of 3/4" plywood provides a solid non-skid, noise absorbing surface (Plywood is not included with the platform.)
- Weight bars, weight plates and accessories sold separately (See page 226-228).

### FULL POWER RACK

813900

\$1,399<sup>22</sup> EA ★



Bar Storage Sleeve

### DOUBLE SIDED HALF RACK

817000

\$1,999<sup>22</sup> EA ★



J-Hook Bar Catch



Resistance Band Attachments

### HALF POWER RACK

813800

816900

817100

- Half Rack and Platform
- Half Rack Only - Floor Mount
- Power Lift Platform Only

\$1,599<sup>22</sup> EA ★

\$999<sup>22</sup> EA ★

\$599<sup>22</sup> EA ★



CHAMPION  
BARBELL.

### SMITH MACHINE

- Constructed of 2" X 3" heavy wall steel tubing
- 7'L - 700 lb capacity bar rotates on precision roller bearings
- Bar uses precision linear bearings to glide friction free on 1" solid case hardened rods
- Solid steel peg and hook safety catch system with separate adjustable safety stops spaced every 7 inches
- Includes 8 weight storage horns
- 84"H x 71.5"W x 68"D - 310 lbs.

815802

\$1,799<sup>22</sup> EA ★



CHAMPION  
BARBELL.

### THUNDER THRUSTER

- Constructed of 2" x 3" heavy wall tubing
- A must for explosive strength and power training
- Uni-lateral motion allows for equal strength development
- Independent arms are equipped with rubber bump stops for quiet operation
- Precision flange bearings for frictionless smooth motion
- Includes 4 weight storage horns with protective sleeves and rubber bump stops
- 83"H x 50"W x 67"D - 360 lbs.

814300

\$999<sup>22</sup> EA ★



CHAMPION  
BARBELL.

### POWER RACK

- Constructed of 2" x 3" heavy wall steel tubing
- Adjustable 1" solid rod safety bars
- Includes pull up bar
- 24" Lifting area between uprights
- 92"H x 48"W x 42"D - 245 lbs.

810900

\$549<sup>22</sup> EA ★



CHAMPION  
BARBELL.

### STEP SQUAT RACK

- Heavy-duty rack offers safety while doing quarter, half or full squats
- Constructed of 2" square heavy wall steel tubing
- Lowest tier is 28" increasing incrementally to the top tier at 60"
- Includes four weight storage horns
- 60"H x 48"W x 65"D - 165 lbs.

816300

\$499<sup>22</sup> EA ★





**CHAMPION BARBELL**

### FIELD HOUSE LEG PRESS

- Constructed of 2" x 3" heavy wall steel tubing
- Pads are constructed of 2.5" high density foam with Black marine grade vinyl
- Delivers a full range of motion with smooth precision pillow block bearings
- Heavy duty rubber bump stops for quiet operation
- Includes 2 weight storage horns with protective sleeves
- 1200 lb. weight capacity
- 59"H x 32"W x 84"L - 480 lbs.

814202

\$1,499<sup>22</sup> EA ★ **S&H**



**CHAMPION BARBELL**

### POWER RAM SLED HACK-MACHINE/LEG PRESS

- This three-way ram sled develops all muscle groups from the lower back and down, including hips, thighs and calves
- 4 start-stop locations to accommodate various height users
- The 85 lb. carriage glides smoothly at a 45 degree angle on 4 precision linear bearings
- Constructed of 2" x 3" heavy wall steel tubing
- Pads are constructed of 2.5" high density foam with Black marine grade vinyl
- Adjustable backrest/footrest to ensure proper angle for exercises
- Equipped with safety catches that can be engaged by user from any position
- 51"H x 32.5"W x 90"D - 400 lbs.

816702

\$1,699<sup>22</sup> EA ★ **S&H**



**CHAMPION BARBELL**

### GLUTE/HAM MACHINE

- Constructed of 2" x 3" heavy wall steel tubing
- Pads are constructed of 2.5" high density foam with Black marine grade vinyl
- Strengthens lower back, hamstrings and core
- Foot pads adjust vertically and horizontally to fit all size users
- Equipped with knee pads to aid with mounting and dismounting
- Includes rear handle used for reverse hyper extensions
- 42"H x 34"W x 60"L - 196 lbs.

814102

\$589<sup>22</sup> EA ★ **S&H**



**CHAMPION BARBELL**

### PLATE LOADED LEG EXTENSION/CURL MACHINE

- Constructed of 2" heavy wall steel tubing
- Pads are constructed of 2.5" high density foam with Black marine grade vinyl
- Ideal for complete leg conditioning and strengthening of knee, thighs and hamstrings
- Features special split pad that allows for the proper isolation of the muscles
- Can be used for leg extension exercises in the sit-up position and leg curls in the prone position
- 38"H x 24"W x 80"L - 110 lbs.

813102

\$499<sup>22</sup> EA ★ **S&H**



**CHAMPION BARBELL.**

**PLATE LOADED NECK MACHINE**

- Constructed of 2" heavy wall steel tubing
- 4 way machine (front/back, left/right) works all the neck muscles
- Arm pivots on precision flange bearings to provide smooth action
- Removable pin is used to restrict direction of head movement
- Fully adjustable seat height
- Includes 2 weight storage horns
- 56"H x 26"W x 48"D - 110 lbs.

813602

\$369<sup>99</sup> EA ★ **S&H**



**CHAMPION BARBELL.**

**PLATE LOADED INCLINE ROWER**

- Constructed of 2" square heavy wall steel tubing
- Olympic plate loaded rower designed to develop the rhomboids, trapezius, anterior deltoids and biceps
- Comfortable chest pad covered with durable Black marine grade vinyl
- Swivel handle bar for proper support and angle while doing heavy lifting and strength training
- 48"H x 27"W x 80"L - 135 lbs.

813002

\$389<sup>99</sup> EA ★ **S&H**

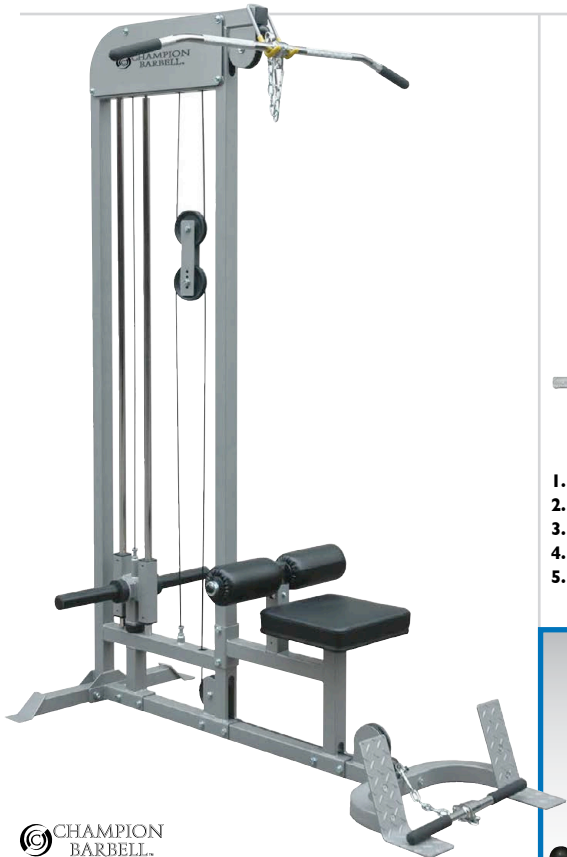

**CHAMPION BARBELL.**

**PLATE LOADED LAT PULLDOWN/LOW ROW COMBO**

- Constructed of 2" square heavy wall steel tubing
- Includes rowing attachment, 20" bar and 48" lat bar
- Equipped with height adjustable seat and knee rollers
- Pad is constructed of 2.5" high-density foam with 40 oz. Black marine grade vinyl
- 86"H x 30"W x 65"L - 185 lbs.

814902

\$799<sup>99</sup> EA ★ **S&H**



**CABLE ATTACHMENTS**

1. <b>CHLBPROX</b>	30" Pro-Style Lat Bar	\$39 <sup>99</sup> EA ★	6. <b>CHLBTRXX</b>	Nylon Tricep Rope	\$27 <sup>99</sup> EA ★
2. <b>CHLB48IX</b>	48" x 1" Lat Bar	\$45 <sup>99</sup> EA ★	7. <b>CHLBVPRS</b>	V Shaped Press Down Bar	\$19 <sup>99</sup> EA ★
3. <b>CHLBHNDL</b>	Single Chrome Handle	\$12 <sup>99</sup> EA ★	8. <b>CHLBMLTI</b>	Revolving Multi-Exercise Bar	\$32 <sup>99</sup> EA ★
4. <b>CHLBV20X</b>	V Press and Lat Bar	\$27 <sup>99</sup> EA ★	9. <b>1101256</b>	Ab Crunch Strap	\$39 <sup>99</sup> EA ★
5. <b>CHLB20RT</b>	20" Rotating Straight Bar	\$24 <sup>99</sup> EA ★	10. <b>1101263</b>	Nylon Ankle Strap	\$18 <sup>99</sup> EA ★



**CABLE ATTACHMENT PACKAGE**  
**PACKAGE INCLUDES 1 OF EACH**

- 20" rotating straight bar
- Tricep lat rope
- "V" shaped press down bar

**1051377** \$59<sup>99</sup> PACK ★

**SAVE 15% NOW \$59.99**  
**GREAT SAVINGS! ON A CABLE ATTACHMENT PACKAGE!**



**CHAMPION BARBELL**  
**CHIN & DIP STATION**

- Constructed of 2" square heavy wall steel tubing
- Multi-grip pull up bar combined with heavy duty dip bar supports with built in step ups
- All welded end caps with tabs for bolting to floor
- 90"H x 26"W x 64"D - 150 lbs.

**814800** \$369<sup>22</sup> EA ★



**CHAMPION BARBELL**  
**AB EXERCISER, DIP & SIT UP BOARD COMBO**

- Constructed of 2" square heavy wall steel tubing
- Use for bent knee raises, straight leg lifts or dips
- Built with 75 degree angle to target abdominal muscles
- Pads are 2.5" high density foam with 40 oz. Black marine grade vinyl
- All welded end caps with tabs for bolting to floor
- 67"H x 25"W x 64"D

**814502** Ab/Dip Only \$349<sup>22</sup> EA ★   
**814602** Combo \$599<sup>22</sup> EA ★

**CHAMPION BARBELL**  
**BACK & ABDOMINAL EXERCISE BENCH**

- Constructed of 2" square heavy wall steel tubing
- Combines hyper extension and Roman chair exercises for the abdomen and lower back
- Adjustable design to accommodate user height
- Pads are 2.5" high density foam with 40 oz. Black marine grade vinyl
- 29.5"H x 36"W x 49.5"D - 93 lbs.

**816502** \$329<sup>22</sup> EA ★



**CHAMPION BARBELL**  
**ADJUSTABLE SIT UP BOARD**

- Constructed of 2" x 3" heavy wall steel tubing
- 6 spring loaded pin positions from 0° - 30° incline
- 16"W x 44"L board is 2.5" high density foam with 40 oz. Black marine grade vinyl
- Ankle and knee supports are fully padded for comfort
- 45"H x 22.5"W x 66.5"L - 63 lbs.

**813302** \$269<sup>22</sup> EA ★



**CHAMPION BARBELL**  
**HEAVY DUTY LEATHER DIP BELT**

- Constructed of heavy-duty leather and steel chain
- Belt is 29"L and chain is 24"L
- Weight plate not included

**CHDBXXXX** \$55<sup>22</sup> EA ★



**CHAMPION BARBELL**  
**CHIN/DIP/AB STATION**

- Constructed of 2" square heavy wall steel tubing
- Multi-grip pull up bar on one side and dip bar and knee raise grips on the other side allows two athletes to exercise simultaneously
- Pads are constructed of 2.5" high-density foam with 40 oz. Black marine grade vinyl
- All welded end caps with tabs for bolting to floor
- 90"H x 26"W x 64"D - 180 lbs.

**814702** \$469<sup>22</sup> EA ★

## CHAMPION BARBELL *SELECTORIZED MACHINES*

### All Champion Barbell Selectorized Equipment Feature:

- Precision bearings and 3/16" stainless steel cables coated in black nylon to 1/4" for a smooth workout
- 200 lb. weight stacks fully encased in a Polycarbonate Shroud
- Instructional placard for proper usage



#### **SELECTORIZED INCLINE / SHOULDER PRESS**

- Works the trapezius, rhomboids, deltoids, pectorals, biceps and triceps
- Adjustable seat and back pads to accommodate different users and multi-position handles to accommodate different workout targets
- 55"H x 52.5"W x 71.5"D - 440 lbs.

812102

\$1,799<sup>99</sup> EA ★ 

#### **SELECTORIZED CHEST PRESS**

- Adjustable seat and multiple position comfort grips to isolate the arms, deltoids and pectorals
- 55"H x 50"W x 36"D - 403 lbs.

810102

\$1,399<sup>99</sup> EA ★ 

#### **SELECTORIZED PECTORAL/DELTOID**

- Works the trapezius, rhomboids, deltoids and pectorals
- Adjustable seat and back pads to accommodate different users
- Indexing plate for adjustable starting positions
- 71.5"H x 51"W x 57"D - 423 lbs.

812202

\$1,799<sup>99</sup> EA ★ 

#### **SELECTORIZED ARM CURL**

- Adjustable seat and indexing cam provide perfect bicep isolation
- 55"H x 35.5"W x 44"D

810302

\$1,399<sup>99</sup> EA ★ 

#### **SELECTORIZED HIP FLEXOR**

- Works the abductors, hamstrings, glutes, hip flexors and quadriceps
- Adjustable leg pad to accommodate different users
- Large cam for multiple start positions (includes stability handles)
- 58.5"H x 39.5"W x 47.5"D - 416 lbs.

800902

\$1,849<sup>99</sup> EA ★



### 4 WAY MULTI-FUNCTION GYM

- Four stations for every aspect of your workout
- Used for chest/shoulder press, leg extension, lat pull down and low row
- 83.5"H x 48"W x 75"L - 537 lbs.

**156002**

 \$1,799<sup>22</sup> EA ★ 

### SELECTORIZED LAT PULL/LOW ROW

- Works multiple muscle groups in back and arms; no cable adjustment needed to switch from lat pull downs to low rows
- Features adjustable knee rollers, stack guard and foot support
- Includes rowing attachment and lat bar; storage hooks hold bar/handle attachments in place when not in use
- 86"H x 36"W x 77.5"L - 423 lbs.

**810202**

 \$1,749<sup>22</sup> EA ★ 

### SELECTORIZED LEG EXTENSION

- Multiple station positions allow you to adjust the range of motion
- Adjustable seat back to accommodate different size users
- 55"H x 46"W x 47"D - 418 lbs.

**812302**

 \$1,649<sup>22</sup> EA ★ 

### SELECTORIZED LEG PRESS

- Fully adjustable seat provides comfort for multiple size users
- Space saving side mounted weight stack design
- 55"H x 48"W x 67"D - 533 lbs.

**811002**

 \$1,999<sup>22</sup> EA ★

## CHAMPION BARBELL

### MULTIFIT SYSTEM

- Perform 11 different exercises in 7 workout stations
- Constructed of 2" square heavy wall steel tubing with a silver powder coated finish (lifetime warranty on welds)
- Built in steps for Chin, Dip & Knee Raise
- Pads are 2.5" high density foam with 40 oz. Black marine grade vinyl

815002

\$1,349<sup>99</sup> EA ★ 

**THE ULTIMATE  
WORKOUT SYSTEM!**

**VARIABLE  
CONFIGURATIONS TO  
FIT YOUR SPACE**

**EXERCISE AREA: 11' L X 5'7" D X 7'6" H WEIGHT: 300 LBS**



SIT UPS



DIP STATION



LAT/PULL UP

ABDOMINAL  
KNEE RAISES45° BACK  
EXTENSION

PUSH UPS

PLYO  
BOX JUMPS

SQUATS

## THE PRO GYM

### 8 TO 16 EXPANDABLE GYM SYSTEM

PRO-GYM weight training machines offer a great deal more actual lifting weight per station than other competitive gyms. All PRO-GYM stations are designed for the ultimate in true lifting action and weight accuracy. The heavy press stations connect directly to the weight stacks by heavy-duty coil springs to absorb vibration, eliminate breakage and reduce noise. All machines use self-locking weight selector keys. All steel frame is **Powder Coated Black**. Minimum ceiling height for all units is 84". Prices shown do not include delivery and installation.

#### American 8

Recommended room area: 12' x 15'.

This unit includes:

- Chest Press
- Dipping
- Abdominal Board (9 levels)
- Quad Low Pulley
- Shoulder Press
- Chinning
- High Lat

720XXXXX

\$6,299<sup>99</sup> EA

#### Blue Chip 8 (As Shown)

Recommended room area: 12' x 15'.

This unit includes:

- Leg Press
- Shoulder Press
- High Lat
- Quad Low Pulley
- Abdominal Board (9 levels)
- Dipping
- Chest Press
- Chinning

721XXXXX

\$7,599<sup>99</sup> EA

#### Pro Combo 16

Recommended room area: 20' x 20'.

This unit includes:

- Leg Press
- Chest Press
- High Lat
- 4-Exercise Leg Flexor
- Extension Station
- Hip Flexor
- Abdominal Board
- Quad Low Pulley
- Dippi

723XXXXX

\$9,999<sup>99</sup> EA

#### Blue Chip 12

Recommended room area: 16' x 18'. This unit includes the same stations as the Blue Chip 8 with the addition of a 4-exercise Leg Flexor/Extension station.

722XXXXX

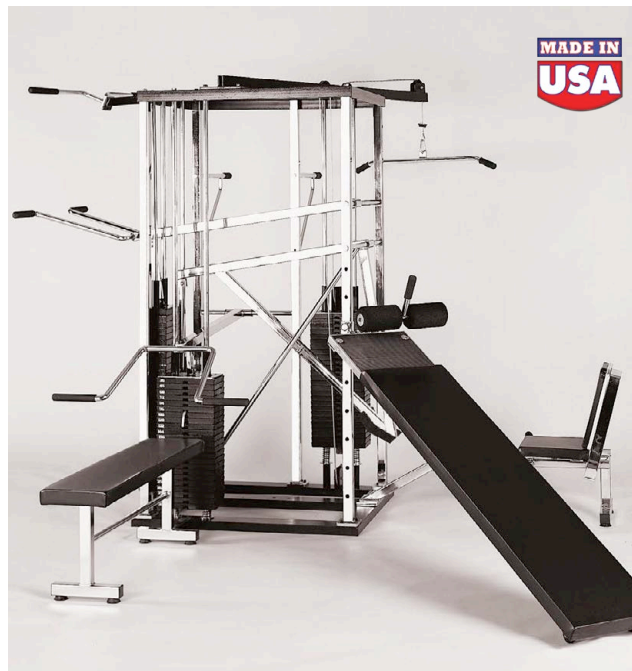
\$8,699<sup>99</sup> EA

Please add \$1299 for Shipping, Handling and Installation in 48 Contiguous States on these Pro Gym Systems



### SELECTORIZED MULTI-STATION

- Frame constructed of 2" x 2" and 2" x 3" 11-gauge high-grade powder coated steel
- Pads constructed of 100% Naugahyde and premium density polyethylene foam, that is sewn and top-stitched
- Each 200 lb. weight stack glides smoothly on 2 - 1" solid case hardened steel rods
- Cables are 3/16" aviation grade stainless steel coated in black nylon to 1/4" thickness
- The 4 basic stations include (1) Combo lat pull down/low row (2) Combo tricep extension/bicep curl and upright row (3) Combo leg extension/curl (4) Combo bench/shoulder/incline press
- Requires an area of 14"W x 14'L x 8.6'H
- **CAUTION:** Before ordering, determine that your floor is strong enough to support the 1,500 lb. weight of the assembled unit.

1382827

\$4,999<sup>99</sup> EA

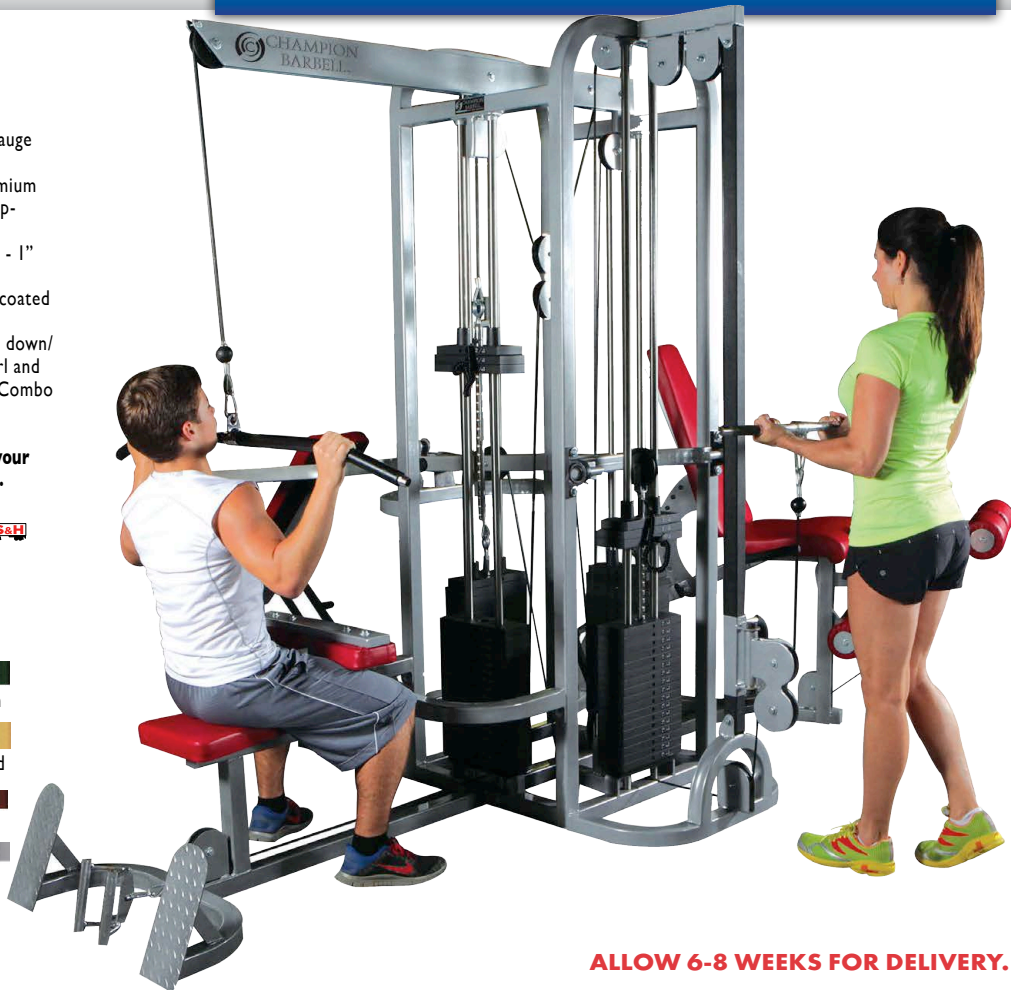

WEIGHT LIFTING

### FRAME AND VINYL COLOR OPTINS



Specify Frame and Vinyl Color when ordering

ALLOW 6-8 WEEKS FOR DELIVERY.



LEG CURL



LEG EXTENSION



LAT PULL DOWN



LOW ROW



CHEST PRESS



INCLINE PRESS

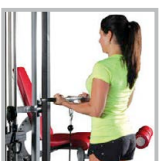

ARM CURL



TRICEP PRESS DOWN

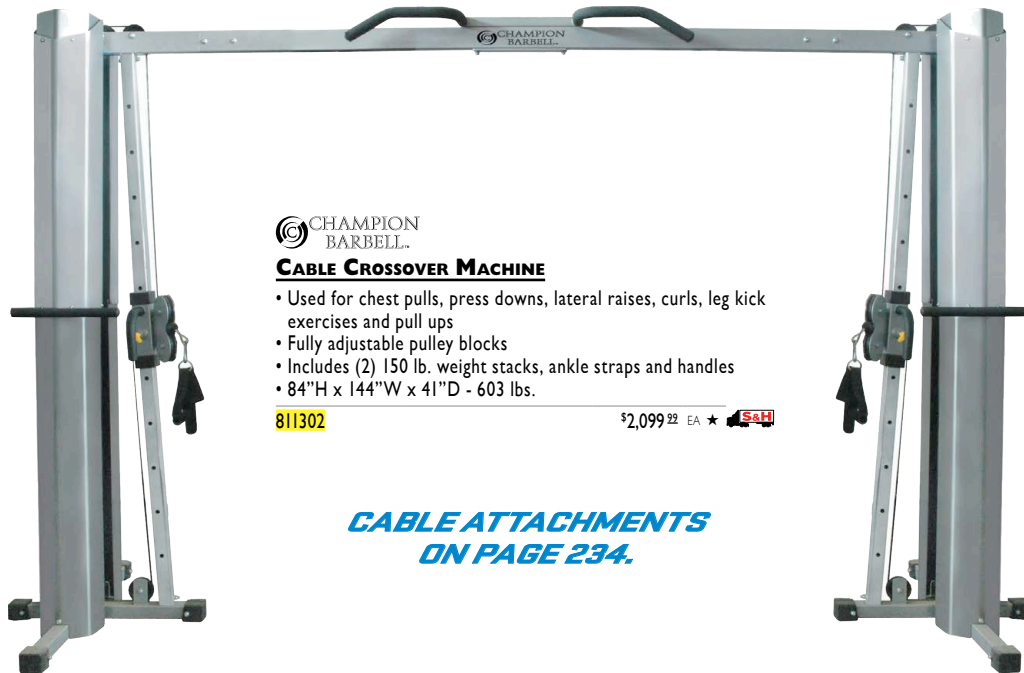

### CABLE CROSSOVER MACHINE

- Used for chest pulls, press downs, lateral raises, curls, leg kick exercises and pull ups
- Fully adjustable pulley blocks
- Includes (2) 150 lb. weight stacks, ankle straps and handles
- 84"H x 144"W x 41"D - 603 lbs.

811302

\$2,099<sup>99</sup> EA ★

**CABLE ATTACHMENTS  
ON PAGE 234.**

## ProIMPACT Professional Grade Rubber Flooring

### INTERLOCKING TILES - 24"

- Flexible & durable recycled material
- Slip & impact resistant for maximum protection
- No adhesive required
- 9MM (3/8")
- Minimum order 50 pieces



1369628 Specify Color \$20<sup>92</sup> EA

### INTERLOCKING TILES - 36"

- Flexible & durable recycled material
- Slip & impact resistant for maximum protection
- No adhesive required
- 9MM (3/8")
- Minimum order 25 pieces

1369632 Specify Color \$50<sup>92</sup> EA

### INTERLOCKING TILES - 48"

- Flexible & durable recycled material
- Slip & impact resistant for maximum protection
- No adhesive required
- 9MM (3/8")
- Minimum order 25 pieces

1369636 Specify Color \$80<sup>92</sup> EA

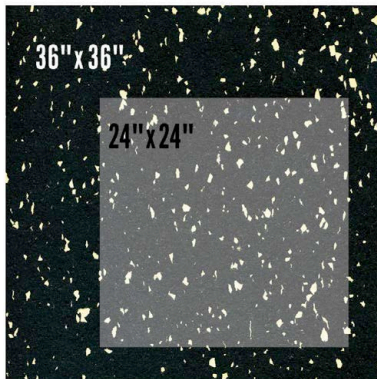
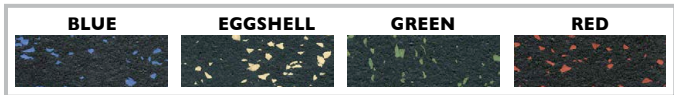

## ProIMPACT Professional Grade Rubber Flooring

### SQUARE TILES - 24"

- Easy to install
- Flexible & durable recycled material
- 9MM (3/8")
- Minimum order 50 pieces

1369640 Specify Color \$20<sup>92</sup> EA

### SQUARE TILES - 36"

- Easy to install
- Flexible & durable recycled material
- 9MM (3/8")
- Minimum order 25 pieces

1369644 Specify Color \$50<sup>92</sup> EA

### INTERLOCKING TILES

- Impact-resistant
- Excellent shock and sound absorbing properties
- Works great for demanding athletic and institutional applications
- 24" x 24" x 8MM (5/16")
- 4 tiles per box/set
- Minimum order 10 boxes

1369649 Black \$80<sup>92</sup> SET

### ROLLED FLOORING

- Made with recycled materials
- Easy installation with fewer seams
- Ideal for use in demanding athletic, commercial, industrial and institutional applications
- 4'W x 25'L x 9MM (3/8") roll
- Adhesive required
- Minimum order 2-rolls

1369648 Black \$339<sup>92</sup> EA

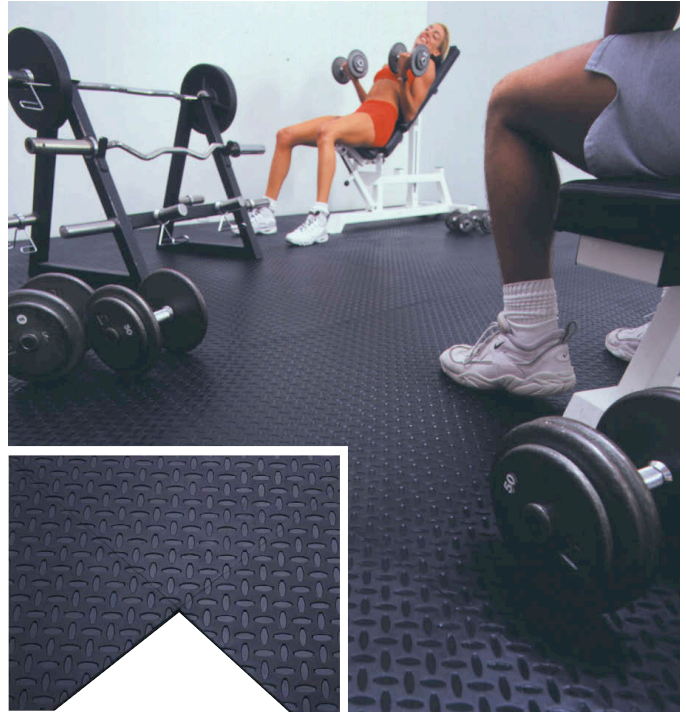

## MITCHELL

### THE DIAMOND PLATE TILE

- 4' x 4' x 3/8" tiles engineered with the same state of the art technology as interlocking floor tiles
- Solid density, high quality rubber materials, not recycled rubber particles
- The Diamond Plate tiles have color completely through not laminated to the surface
- Cleans easily with a broom or slightly damp mop
- Dense enough to stay where laid, no adhesive needed

FTDIAB	Black	\$169 <sup>92</sup> EA
FTDIAC	Grey, Dust Blue	\$199 <sup>92</sup> EA
1248944	Khaki, Terra Cotta, Brown, Green	\$229 <sup>92</sup> EA
1248982	Red	\$299 <sup>92</sup> EA
1249002	Royal	\$249 <sup>92</sup> EA
1278999	Burgundy	\$239 <sup>92</sup> EA



### ZIP-TILE INTERLOCKING FLOORING

- Interlocking 3/8" thick tiles are easy to handle and install
- Tiles are 28.5" x 28.5" with no corner or edge pieces required; simply cut tiles to fit any room
- Unique tab design holds the tiles together, eliminating the need for adhesives or tape
- Easy to clean and maintain
- Made in the USA out of 88% recycled rubber content



1300154 Black \$20<sup>92</sup> EA  
1300161 Specify Flec Color \$25<sup>92</sup> EA

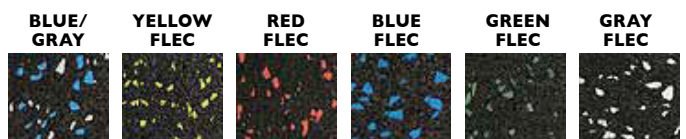





## ATHLETIC FLOORING MATS

- A cost effective alternative to other types of expensive flooring
- Protect floor from damage caused by the impact from dropping barbells
- Has cushioning features that protect free weight area floors from dings, scuffs, and other damage
- Available in 1/2" and 3/4" thicknesses and in 3'W x 4'L or 4'W x 6'L sizes
- Uses environmentally friendly recycling technologies; manufactured completely in the USA
- Black only

CHMAT1/2	3'W x 4'L x 1/2"	\$46 <sup>22</sup> EA	
CHMAT3/4	3'W x 4'L x 3/4"	\$55 <sup>22</sup> EA	
CHMTF1/2	4'W x 6'L x 1/2"	\$93 <sup>22</sup> EA	
CHMTF3/4	4'W x 6'L x 3/4"	\$99 <sup>22</sup> EA	

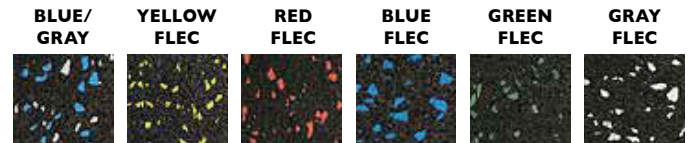
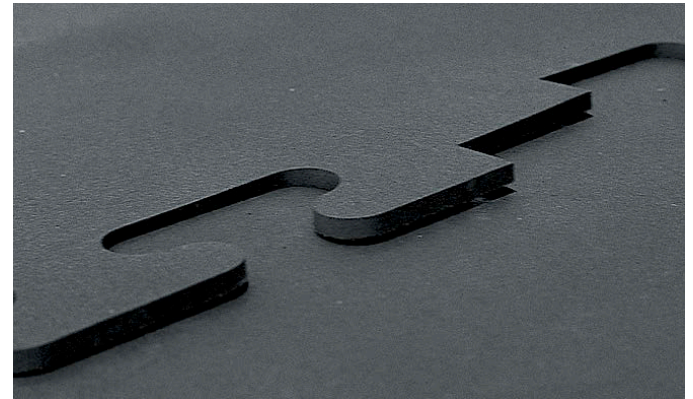

## MEGA-LOCK & FLEC-LOCK INTERLOCKING WEIGHT ROOM FLOORING

- Pieces are 30" x 30" x 1/2" thick
- Precision cut, seamless appearance, interlocking mat that is large enough to not require adhesive, but still small enough to be manageable
- Constructed of premium recycled rubber and/or colored EPDM rubber pieces
- Highly resilient, anti-fatigue qualities found naturally in rubber are enhanced by a space age polymer binder used during manufacturing
- Flec-Lock mats contain 10% EPDM color flecs

20015530	Mega-Lock Black - Center	\$30 <sup>22</sup> EA
20015532	Mega-Lock Black - Edge	\$30 <sup>22</sup> EA
20015531	Mega-Lock Black - Corner	\$30 <sup>22</sup> EA
20015533	Flec-Lock Colors - Center	\$32 <sup>22</sup> EA
20015535	Flec-Lock Colors - Edge	\$32 <sup>22</sup> EA
20015534	Flec-Lock Colors - Corner	\$32 <sup>22</sup> EA

## FLOORING/MAT CLEANER

- Highly concentrated, phosphate-free formula designed to work with all of RB Rubber flooring systems
- Provides an economical, effective cleaning and deodorizing system for rubber, urethane and other inanimate hard surfaces and synthetic floors in areas that are normally hard to keep fresh smelling such as gyms, schools, clubs and indoor recreation facilities

20015536 \$37<sup>22</sup> GAL



## CX-941 POLYURETHANE ADHESIVE FOR ROLLOUT RUBBER FLOORING

- CX-941 is a polyurethane-based, structural, trowel grade industrial adhesive
- Elastomer properties enable it to move with rubber as it expands and contracts
- Patented formula is VOC compliant, non-flammable, and contains no solvents or water
- Formulated for indoor and outdoor applications on concrete, asphalt, rubber, cork, plywood, particle or chip board, cement, gypsum and over radiant heat flooring
- Will fully bond in just over two hours
- Provides 60-65 square feet of coverage per gallon

1008319	2 Gallon Pail	\$159 <sup>22</sup> EA
1008326	5 Gallon Pail	\$349 <sup>22</sup> EA

**Adhesives are only necessary for rolled flooring.  
Failure to use recommended adhesives may void warranty.**



**NOW AVAILABLE IN FLEC COLORS!**

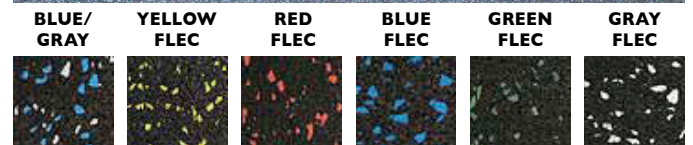

## SPORT ROLL FLOORING

- 100% recycled rubber rolls specially designed and manufactured for durability
- Serve as an effective buffer against acoustical vibration
- Suitable for both interior, exterior applications - ideal for surfacing areas that require resilience, sound absorption, spike resistance and traction
- Rolls are 3/8" thick and 4' wide and available in 25', 50' and 75' lengths
- Flec rolls contain 17% EPDM color flecs
- Adhesives are necessary for rolled flooring; Failure to use recommended adhesives may void warranty

1008500	4'W x 25'L x 3/8" - Black	\$289 <sup>22</sup> EA	
1377217	4'W x 25'L x 3/8" - Specify Color	\$359 <sup>22</sup> EA	
1008388	4'W x 50'L x 3/8" - Black	\$579 <sup>22</sup> EA	
1379866	4'W x 50'L x 3/8" - Specify Color	\$699 <sup>22</sup> EA	
1008449	4'W x 75'L x 3/8" - Black	\$829 <sup>22</sup> EA	
1379873	4'W x 75'L x 3/8" - Specify Color	\$1,049 <sup>22</sup> EA	



**NEW!**



**XT685 LIGHT COMMERCIAL TREADMILL**

- Requires 110 volt power supply
- Includes: 9" blue backlit LCD, Heart Rate % profile, Muscle Activation Profile, Integrated Speakers with Audio Jack, Swivel Fan, Water Bottle or Cargo Compartment and an Integrated Reading Rack
- 10 operation modes: Manual, Hill, Fat Burn, Cardio, Strength, Interval, Fusion, Calorie, 2 Heart Rate, 2 User
- Contact and telemetric heart rate monitor (wireless chest strap included)
- 0 - 15% grade incline and 0.5 - 12 mph speed
- 3.75 hp DC drive motor
- 56"H x 32"W x 78"L - 273 lbs.
- 425 lbs. maximum user weight

**5 Year Limited Warranty**

1388453 \$2,199<sup>99</sup> EA



**CTI FULL COMMERCIAL TREADMILL**

- Requires 220 volt power supply
- Leeson Vector drive 5 hp motor
- Speed: 0.5 to 12 mph
- Run belt: 22" x 62" with 3" Rollers
- 7 programmed workout settings: constant load, weight loss, interval, CV workout, Heart rate control, Fat burn, Rolling hills, each has 8 class selections that alter total resistance and can be graphically seen in the "Workout Profile display" plus 1 manual program
- Workout data: time, heart rate, watts, distance, speed, rpm, METS, workout level, calories
- Heart rate: contact grips and wireless
- 60"H x 35"W x 82"L - 385 lbs.
- 450 lbs. maximum user weight

**3 Year Limited Warranty**

1270938 \$6,499<sup>99</sup> EA



**T60 LIGHT COMMERCIAL TREADMILL**

- Requires 110 volt power supply
- Includes heart rate control and 26 built-in programs including six Custom Learn programs
- Console Feedback: Elevation, Heart Rate, Time, Calories, Speed, Distance
- Speed: 0.5 - 10MPH
- 58"H x 31"W x 82"L - 256 lbs.
- 350 lbs. maximum user weight

1205886  
1248210

HRM Chest Strap

\$2,599<sup>99</sup> EA   
\$48<sup>99</sup> EA



**CT800 FULL COMMERCIAL TREADMILL**

- Requires 110 volt power supply
- Large blue-LED matrix with 4 Separate LED information windows, a 20-character LED message center, LED heart rate bar and an integrated reading rack
- 9 operation modes: Manual, Interval, 5k, Hill, Fat Burn, Cardio, Fit Test, 2-Hour and Custom
- Contact and telemetric heart rate monitor
- 0 - 15% grade incline and 0.5 - 12 mph speed
- 4.0 hp DC drive motor
- 57"H x 35"W x 84"L - 230 lbs.
- 450 lbs. maximum user weight

**5 Year Limited Warranty**

1364697 \$3,099<sup>99</sup> EA



**FOLDING TREADMILL**

- Requires 110 volt power supply
- Personalized Workouts: 3 user customized programs, stores variable speed/incline levels up to 30 minutes per program
- Preset Workouts: 15, 30 and 45 minute durations, with variable speed (0-10 mph) and incline (0% - 12% grade)
- Operating Footprint: 46.5"H x 36"W x 67"L - 230 lbs.
- Folded Footprint: 62"H x 36"W x 35.5"L

20028142

\$1,949<sup>99</sup> EA

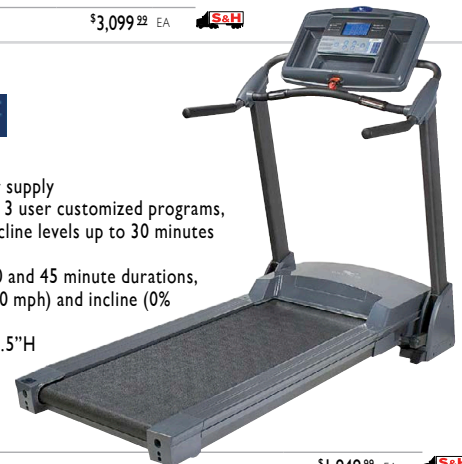

**FOAM EQUIPMENT MAT**

- Constructed of 1/4" heavy duty closed cell foam
- Economical way to provide added protection to floors
- Aids in reducing noise and is rolled easily for storage
- Pebbled top surface adds non-slip traction for user and equipment

200153X4 3' x 4' Bike Mat \$39<sup>99</sup> EA  
200153X6 3' x 6' Treadmill Mat \$49<sup>99</sup> EA





**UNIX P ELLIPTICAL CROSS TRAINER**

- Back-Lit LCD computer display provides high resolution and easy to read digital and graphical data
- Informative feedback computer provides: Speed, RPM, Distance, Time, Energy Consumption, Pulse Rate and Resistance Brake Level
- Poly "V" drive belt permits silent operation
- 110 volt power source (outlet) is required
- 60"H x 23"W x 57"L - 165lbs.

1362381 \$1,599<sup>22</sup> EA



**FitnEX E70 LIGHT COMMERCIAL ELLIPTICAL**

- Self-generating power
- 8 built-in programs with 16 levels of resistance
- Feedback includes: time, work level, watts, distance, speed, METs, heart rate and calories burned
- Display: Matrix + LED
- Torque: 250 Watts
- 67"H x 21"W x 73"L - 220 lbs.
- 400 lbs. maximum user weight

1205916 \$2,599<sup>22</sup> EA   
1248210 HRM Chest Strap \$48<sup>22</sup> EA

**NEW!**



**STEPMILL 3**

- Requires 110 volt power supply
- Revolving staircase with six, 6"H x 17"W x 9"D steps
- Backlit LCD console display provides easy to read digital and graphical data
- Informative feedback includes: Elapsed time, speed level, calories burned, heart rate, floors
- Step range of 26 to 162 per minute
- Contact and telemetric hear rate monitor
- 73"H x 29"W x 46"L - 227 lbs.
- 300 lbs. maximum user weight

**2 Year Limited Warranty**

1388450 \$3,499<sup>22</sup> EA



**CE800 ELLIPTICAL**

- Large blue-LED matrix with 4 Separate LED information windows, a 20-character LED message center, LED heart rate bar and an integrated reading rack
- 10 operation modes: Manual, Hill, Fat Burn, Cardio, Strength, Interval, Custom, Fit Test, 2 Heart Rate
- Contact and telemetric heart rate monitor
- 40 resistance levels
- Integrated generator and 30 lb. flywheel system
- Oversized foot pedals with 2-degree inversion
- 67"H x 28"W x 78"L - 240 lbs.
- 450 lbs. maximum user weight

**5 Year Limited Warranty**

1364698 \$2,599<sup>22</sup> EA



**COACH E ROWER**

- Biomechanically designed foot plates offer a natural, pivoting action and a full longitudinal rowing motion range
- Comfortable padded seat and top grade rollers with sealed ball bearings provide a smooth glide along the maintenance-free chrome plated steel rails
- LCD training computer displays: time, oar strokes, current cadence, cumulative distance over a training session, heart rate and kilojoules
- 26"H x 20"W x 80"L - 105 lbs.
- 285 lbs. maximum user weight

**3 Year Limited Warranty**

1335576 \$1,699<sup>22</sup> EA



**E GLIDE ELLIPTICAL**

- Patent-pending direct drive system
- Large foot pedals with slip-resistant design and sweat drain
- Heavy gauge steel frame
- Easy-to-use console with micro-tension resistance
- Telemetric heart rate
- 66"H x 24"W x 69"L - 230 lbs.
- 450 lbs. maximum user weight

**5 Year Limited Warranty**

1362077 \$2,499<sup>22</sup> EA





**R70 LIGHT COMMERCIAL RECUMBENT BIKE**

- For professional light commercial use
- Self-generating power
- 8 built-in programs with 16 levels of resistance
- Feedback includes: time, work level, watts, distance, speed, METs, heart rate and calories
- Display: Matrix + LED
- Torque: 250 Watts
- 45"H x 21"W x 64"L - 165 lbs.
- 400 lbs. maximum user weight

**1205909** \$2,149<sup>99</sup> EA **S&H**  
 1248210 HRM Chest Strap \$48<sup>99</sup> EA



**CR800 RECUMBENT BIKE**

- Extra smooth ride comes from the perfect gearing and the integrated generator/flywheel system
- Console offers multiple programs
- 2 degrees of inversion at the padded foot pedals places the user in a comfortable, anatomically correct position
- 30 lb. flywheel combined with the weight of each crank arm produces the ideal amount of inertia
- 40 levels of resistance to satisfy the needs of beginners or advanced exercisers
- 51"H x 30"W x 57"L - 145 lbs.
- 450 lbs. maximum user weight

**5 Year Limited Warranty**  
 1364699 \$1,899<sup>99</sup> EA **S&H**



**CRI COMMERCIAL RECUMBENT BIKE**

- 7 Programmed workout settings: Constant load, Weight loss, Interval, CV Workout, Heart Rate Control, Fat Burn, Rolling Hills. Each program has 8 "class" selections that alter the total resistance and can be graphically seen in the "Workout Profile Display"
- Workout Data includes: Time, Heart Rate, Watts, Calories, Distance, METS, Workout Level Speed and RPM.
- 53"H x 29"W x 53"L - 154 lbs.
- 400 lbs. maximum user weight

**3 Year Limited Warranty**  
 1205879 \$2,699<sup>99</sup> EA **S&H**  
 1248210 HRM Chest Strap \$48<sup>99</sup> EA



**B70 LIGHT COMMERCIAL UPRIGHT BIKE**

- Built for professional light commercial use
- Self-generating power
- 8 built-in programs with 16 levels of resistance
- Feedback includes time, work level, watts, distance, speed, METs, heart rate and calories
- Display: Matrix + LED
- Torque: 250 Watts
- 53"H x 21"W x 42"L - 117 lbs.
- 400 lbs. maximum user weight

**1205893** \$1,699<sup>99</sup> EA **S&H**  
 1248210 HRM Chest Strap \$48<sup>99</sup> EA



**NEW!**



**CU800 UPRIGHT BIKE**

- Large blue-LED matrix display with 4 Separate information windows, a 20-character message center, heart rate bar and an integrated reading rack
- Generator powered console means there is no need for electricity
- Contact and telemetric heart rate monitor
- 40 resistance levels
- Dual spring seat with fore/aft adjustment for extra comfort
- Integrated generator and 30 lb. flywheel system
- 53"H x 21"W x 42"L - 115 lbs.
- 450 lbs. maximum user weight

**5 Year Limited Warranty**  
 1386461 \$1,699<sup>99</sup> EA **S&H**



**CBI COMMERCIAL UPRIGHT BIKE**

- 7 Programmed workout settings: Constant Load, Weight Loss, Interval, CV Workout, Heart Rate Control, Fat Burn and Rolling Hills. Each with 8 "class" selections that alter the total resistance and can be graphically seen in the "Workout Profile Display"
- Workout data includes: Time, Heart Rate, Watts, Calories, Distance, METS, Workout Level, Speed and RPM. Data can be viewed in either Alphanumeric or Dot Matrix display
- 60"H x 27"W x 51"L - 139 lbs.
- 400 lbs. maximum user weight

**3 Year Limited Warranty**  
 1205862 \$2,299<sup>99</sup> EA **S&H**  
 1248210 HRM Chest Strap \$48<sup>99</sup> EA



**VELOCITY EXERCISE BIKE**

- Heavy-duty adjustable spring/shock rider suspension for greater comfort
- Comfort gel saddle with mid-section cutaway for reduced seating pressure
- Ultra-smooth, quiet Poly-V Drive Belt system needs no-maintenance & can be tensioned without removing drive cover
- 47 lb. stainless flywheel in pillow-block bearing for super-fluid spinning
- Nonskid rubber feet can be adjusted for uneven surfaces
- Ergonomic triathlon-style handle bar offers multiple hand positions
- 55"H x 25"W x 44"L - 129 lbs.
- 300 lbs. maximum user weight

1205855

\$1,099<sup>99</sup> EA



**NEW!**



**IC Pro20 BIKE**

- Professional exercise bike designed for intensive use in institutions and gymnasiums
- Zinc galvanized steel frame with black satin powder coated finish
- Chain drive with forged steel crank and ISIS oversized bottom bracket
- 38 lb. flywheel weight
- Includes transport wheels for easy portability
- 44"H x 22.5"W x 50"L - 130 lbs.
- 350 lbs. maximum user weight

**2 Year Limited Warranty**

1388448

\$1,119<sup>99</sup> EA



**REVOLUTION CLUB CYCLE**

- Resistance system features over sized, center-pull brake pads controlled by a five position "click stop" lever located conveniently near the handlebar
- Welded frame, no nuts and bolts, and each cycle comes with its own spare parts kit
- 39.6 lb. flywheel weight
- Lifetime guarantee on frame, 1 year on parts
- 42.5"H x 24"W x 42.3"L - 113 lbs.
- 250 lbs. maximum user weight

CH94943X

\$769<sup>99</sup> EA



**NEW!**



**AIR FIT BIKE**

- Robust full commercial steel frame with black hammertone finish
- Display measurements include: RPM's, Time, Speed, Distance, Heart Rate and Calories
- Dual action arms simultaneously works the upper body
- Adjustable seat accommodates users of different body sizes
- Includes transport wheels for easy mobility
- 58"H x 29"W x 51"L - 123 lbs.
- 350 lbs. maximum user weight

**2 Year Limited Warranty**

1388449

\$2,699<sup>99</sup> EA



**AIR-I EXERCISE FAN BIKE**

- Dual action arms simultaneously works the upper body
- Easy to use computer scans functions, tracks speed, time, distance and calories
- Fan flows air past the body providing a cool comfortable feeling
- Adjustable seat accommodates users of different body sizes
- Includes transport wheels for easy mobility
- 47.5"H x 25"W x 45"L - 82 lbs.
- 250 lbs. maximum user weight

1375529

\$499<sup>99</sup> EA



**MOMENTUM EXERCISE BIKE**

- Professional exercise bike designed for intensive use in institutions and gymnasiums
- 44 lb. flywheel weight
- Sleek look with protective flywheel cover
- Safe pinlocking seat
- Includes transport wheels for easy portability
- 55"H x 20"W x 43"L - 120 lbs.
- 275 lbs. maximum user weight

1272246

\$749<sup>99</sup> EA



**REACTOR KETTLEBELLS**  
by CHAMPION BARBELL

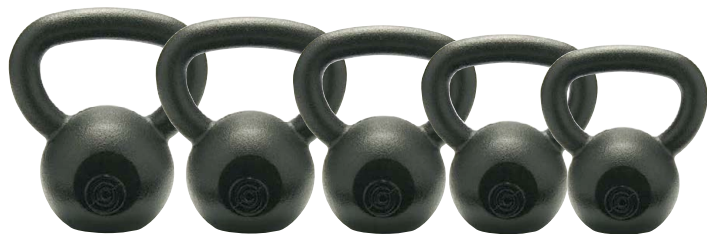

**KETTLEBELLS**

- Combine strength training, muscle coordination and aerobic exercise all in one product
- Helps develop muscle tone, strength and flexibility while promoting fat loss
- Can be used for both upper and lower body workouts

<b>1266733</b>	10 lb.	\$22 <sup>22</sup> EA ★	<b>1266801</b>	45 lb.	\$99 <sup>22</sup> EA ★
<b>1266740</b>	15 lb.	\$33 <sup>22</sup> EA ★	<b>1277470</b>	50 lb.	\$129 <sup>22</sup> EA
<b>1266757</b>	20 lb.	\$46 <sup>22</sup> EA ★	<b>1277487</b>	60 lb.	\$149 <sup>22</sup> EA
<b>1266764</b>	25 lb.	\$56 <sup>22</sup> EA ★	<b>1277494</b>	70 lb.	\$169 <sup>22</sup> EA
<b>1266771</b>	30 lb.	\$67 <sup>22</sup> EA ★	<b>1277500</b>	80 lb.	\$189 <sup>22</sup> EA
<b>1266788</b>	35 lb.	\$79 <sup>22</sup> EA ★	<b>1277517</b>	90 lb.	\$209 <sup>22</sup> EA
<b>1266795</b>	40 lb.	\$89 <sup>22</sup> EA ★	<b>1277524</b>	100 lb.	\$229 <sup>22</sup> EA



**SOFT KETTLEBELLS**

- Sand filled base covered with soft neoprene fabric and foam handles
- Easier on hands and wrist and will not damage floors
- Improves both strength and endurance
- Great for core exercises

<b>1369618</b>	6 lb.	\$13 <sup>22</sup> EA ★
<b>1369605</b>	8 lb.	\$16 <sup>22</sup> EA ★
<b>1369606</b>	10 lb.	\$18 <sup>22</sup> EA ★
<b>1369607</b>	12 lb.	\$23 <sup>22</sup> EA ★
<b>1369619</b>	16 lb.	\$26 <sup>22</sup> EA ★



**8" RUBBER KETTLEBELLS**

- All sizes (weights) are 8" diameter
- Combine strength training & muscle coordination training
- Develop muscle tone, strength and flexibility while promoting fat loss
- Effective for both upper and lower body work-outs

<b>1361735</b>	6 lb. - Light Blue	\$52 <sup>22</sup> EA ★	<b>1361780</b>	16 lb. - Green	\$87 <sup>22</sup> EA ★
<b>1361742</b>	8 lb. - Red	\$56 <sup>22</sup> EA ★	<b>1361797</b>	18 lb. - Purple	\$94 <sup>22</sup> EA ★
<b>1361759</b>	10 lb. - Yellow	\$63 <sup>22</sup> EA ★	<b>1361803</b>	20 lb. - Light Blue	\$104 <sup>22</sup> EA ★
<b>1361766</b>	12 lb. - Royal Blue	\$70 <sup>22</sup> EA ★	<b>1361810</b>	25 lb. - Red	\$112 <sup>22</sup> EA ★
<b>1361773</b>	14 lb. - Orange	\$79 <sup>22</sup> EA ★	<b>1361827</b>	30 lb. - Yellow	\$122 <sup>22</sup> EA ★



**6" MINI RUBBER KETTLEBELLS**

- All sizes (weights) are 6" diameter
- Great for groups or individual training
- Handle design allows for greater comfort
- Versatile for core function, abdominal strength and rotational movement training

<b>1361674</b>	3 lb. - Yellow	\$22 <sup>22</sup> EA ★
<b>1361681</b>	4 lb. - Blue	\$25 <sup>22</sup> EA ★
<b>1361698</b>	5 lb. - Orange	\$27 <sup>22</sup> EA ★
<b>1361704</b>	6 lb. - Green	\$29 <sup>22</sup> EA ★
<b>1361711</b>	7 lb. - Purple	\$32 <sup>22</sup> EA ★
<b>1361728</b>	8 lb. - Orange	\$38 <sup>22</sup> EA ★



**VINYL COATED KETTLEBELLS**

- Vinyl coated to protect flooring and reduce noise

<b>1266818</b>	10 lb. - Light Blue	\$27 <sup>22</sup> EA ★
<b>1266825</b>	15 lb. - Red	\$41 <sup>22</sup> EA ★
<b>1267280</b>	20 lb. - Yellow	\$52 <sup>22</sup> EA ★
<b>1267297</b>	25 lb. - Royal	\$67 <sup>22</sup> EA ★
<b>1267303</b>	30 lb. - Orange	\$79 <sup>22</sup> EA ★
<b>1267310</b>	35 lb. - Kelly Green	\$94 <sup>22</sup> EA ★
<b>1267327</b>	40 lb. - Purple	\$105 <sup>22</sup> EA ★
<b>1267334</b>	45 lb. - Black	\$118 <sup>22</sup> EA ★



**KETTLEBELL STORAGE RACK**

- Holds any size kettlebell on 3 shelves
- Back lip on each shelf prevents fall through
- Heavy-duty all steel construction

<b>1342611</b>	33"H x 31"W x 23"D	\$299 <sup>22</sup> EA ★
----------------	--------------------	--------------------------

**REACTOR** MEDICINE BALLS  
by CHAMPION BARBELL



**HEAVY MEDICINE BALLS**

- Heavy weight for complete body workout
- Provides resistance training through a full range of motion
- Improve performance, reduce the risk of injury, improve balance and build strength
- Not designed for use in slamming exercises

<b>1364666</b>	20 lb. - Yellow	<b>\$119<sup>22</sup></b> EA ★
<b>1364664</b>	25 lb. - Maroon	<b>\$128<sup>22</sup></b> EA ★
<b>1364665</b>	30 lb. - Dark Green	<b>\$149<sup>22</sup></b> EA ★



**MEDICINE BALLS WITH HANDLE**

- Ideal for abdominal training, rotational movements and strength training
- Solid molded handles with plastic, textured grips for a more secure, comfortable grip and greater durability for intense training
- Color coded sizes for easy identification

<b>1266412</b>	6.6 lb. - Yellow	<b>\$49<sup>22</sup></b> EA ★	<b>1266443</b>	13.2 lb. - Green	<b>\$61<sup>22</sup></b> EA ★
<b>1266429</b>	8.8 lb. - Royal	<b>\$51<sup>22</sup></b> EA ★	<b>1266450</b>	15.4 lb. - Purple	<b>\$64<sup>22</sup></b> EA ★
<b>1266436</b>	11 lb. - Orange	<b>\$55<sup>22</sup></b> EA ★			



**V2 MEDICINE BALLS**

- Features an 18 oz. impact absorbing, moisture resistant, flexible polyurethane shell that is textured for grip
- The hand-sewn casing design and expert construction ensure that the implement remains dimensionally stable and balanced for the life of the ball
- All weights are 14" in diameter

PMTAI361	4 lb.	<b>\$84<sup>22</sup></b> EA
PMTAI362	6 lb.	<b>\$94<sup>22</sup></b> EA
PMTAI363	8 lb.	<b>\$99<sup>22</sup></b> EA
PMTAI364	10 lb.	<b>\$104<sup>22</sup></b> EA
PMTAI365	12 lb.	<b>\$109<sup>22</sup></b> EA
PMTAI366	14 lb.	<b>\$114<sup>22</sup></b> EA
PMTAI367	16 lb.	<b>\$119<sup>22</sup></b> EA
PMTAI368	18 lb.	<b>\$124<sup>22</sup></b> EA
PMTAI369	20 lb.	<b>\$134<sup>22</sup></b> EA



**NEW!**  
**REACTOR**  
by CHAMPION BARBELL  
**WRECKING BALLS**

- These medicine balls are indestructible and you can drop, pass, throw and slam them with confidence
- The cover material contains Dupont™ Kevlar® brand fiber and features a special texture for maximum grip and control
- Sewn in logo and weight identifiers won't wear off like printed labels
- Specifically designed for limited bounce

1388454	10" - 4 lb.	<b>\$89<sup>22</sup></b> EA
1388455	10" - 6 lb.	<b>\$94<sup>22</sup></b> EA
1388456	10" - 8 lb.	<b>\$99<sup>22</sup></b> EA
1388457	10" - 10 lb.	<b>\$104<sup>22</sup></b> EA
1388458	10" - 12 lb.	<b>\$109<sup>22</sup></b> EA
1388459	14" - 14 lb.	<b>\$119<sup>22</sup></b> EA
1388460	14" - 16 lb.	<b>\$124<sup>22</sup></b> EA
1388461	14" - 18 lb.	<b>\$129<sup>22</sup></b> EA
1388462	14" - 20 lb.	<b>\$134<sup>22</sup></b> EA
1388463	14" - 25 lb.	<b>\$139<sup>22</sup></b> EA
1388464	14" - 30 lb.	<b>\$144<sup>22</sup></b> EA



**RUBBER MEDICINE BALLS**

- Durable textured rubber cover makes them easy to grip
- Air filled with limited bounce
- Color coded sizes for easy identification
- Not designed for use in slamming exercises

<b>1266283</b>	2.2 lb. - Light Blue	<b>\$26<sup>22</sup></b> EA ★
<b>1266290</b>	4.4 lb. - Red	<b>\$33<sup>22</sup></b> EA ★
<b>1266306</b>	6.6 lb. - Yellow	<b>\$41<sup>22</sup></b> EA ★
<b>1266313</b>	8.8 lb. - Royal	<b>\$50<sup>22</sup></b> EA ★
<b>1266320</b>	11 lb. - Orange	<b>\$58<sup>22</sup></b> EA ★
<b>1266337</b>	13.2 lb. - Green	<b>\$64<sup>22</sup></b> EA ★
<b>1266344</b>	15.4 lb. - Purple	<b>\$78<sup>22</sup></b> EA ★



**MEDICINE BALLS**

- Traditional design, sizes and weights
- Synthetic leather cover
- Color coded sizes for easy identification
- Not designed for use in slamming exercises

<b>1266238</b>	4-6 lb. - Red	<b>\$19<sup>22</sup></b> EA ★	<b>1266276</b>	15-16 lb. - Green	<b>\$38<sup>22</sup></b> EA ★
<b>1266245</b>	6-7 lb. - Yellow	<b>\$24<sup>22</sup></b> EA ★	<b>1377213</b>	17-18 lb. - Purple	<b>\$40<sup>22</sup></b> EA ★
<b>1266252</b>	9-10 lb. - Blue	<b>\$29<sup>22</sup></b> EA ★	<b>1377214</b>	19-20 lb. - Yellow	<b>\$43<sup>22</sup></b> EA ★
<b>1266269</b>	11-12 lb. - Orange	<b>\$31<sup>22</sup></b> EA ★			



**SMASH BALLS**

- Specifically designed to smash and slam without bouncing or rolling
- Durable textured cover to withstand the most demanding slam workouts
- Latex free PVC cover will not split or crack
- Sand filled center shifts with exercise movements to engage core and stabilizer muscles
- Ball diameter varies from 7" to 10" depending on weight

<b>1375501</b>	6 lb. - 7" Dia.	<b>\$31<sup>22</sup></b> EA ★
<b>1375502</b>	8 lb. - 7" Dia.	<b>\$34<sup>22</sup></b> EA ★
<b>1375503</b>	10 lb. - 7" Dia.	<b>\$39<sup>22</sup></b> EA ★
<b>1375504</b>	15 lb. - 9" Dia.	<b>\$49<sup>22</sup></b> EA ★
<b>1375505</b>	20 lb. - 9" Dia.	<b>\$54<sup>22</sup></b> EA ★
<b>1375506</b>	25 lb. - 9" Dia.	<b>\$59<sup>22</sup></b> EA ★
<b>1375507</b>	30 lb. - 10" Dia.	<b>\$64<sup>22</sup></b> EA ★
<b>1375508</b>	35 lb. - 10" Dia.	<b>\$69<sup>22</sup></b> EA ★



**REACTOR**  
CHAMPION BARBELL

**WORK OUT BAR**

- 48" long weighted steel bars
- Rubber coated foam covers bars for easy grip while exercising
- Great for incorporating into squats, lunges, dead lifts, bicep curls and dead rows
- Color coded sizes for easy identification

1266467	4 lb.	\$26.22 EA ★
1266474	6 lb.	\$32.22 EA ★
1266481	9 lb.	\$35.22 EA ★
1266498	12 lb.	\$40.22 EA ★
1266504	15 lb.	\$45.22 EA ★
1266511	18 lb.	\$50.22 EA ★



**REACTOR**  
CHAMPION BARBELL

**WORK OUT BAR STORAGE RACK**

- 16-gauge powder coated rectangular tube and cold rolled steel construction
- Completely welded with no assembly required
- Holds up to 35 bars depending on size

1205572	33"H x 24"W x 18"D	\$169.22 EA ★
---------	--------------------	---------------



**REACTOR**  
CHAMPION BARBELL

**WORK OUT BAR CART**

- Rigid tubular steel design easily stores large quantities of weighted work out bars
- Black powder coated finish
- 6 tiers on each side
- Heavy-duty casters with locking feature on 2

1367751	48"H x 34"W x 25"D	\$219.22 EA ★
---------	--------------------	---------------



**REACTOR**  
CHAMPION BARBELL

**AEROBAR**

- Rather than lifting static weight, user resists the force of moving weight
- Provides up to 250 muscle contractions per minute
- Great for general fitness, sport-specific training, rehab, strength and aerobic conditioning
- Heavy-duty composite material with comfort grip handle and padded rubber safety tips

1369601	48"L	\$24.22 EA ★
---------	------	--------------



**WSU**  
WHILE SUPPLIES LAST

**BRAIDED RUBBER TUBE**

- Durable training tools that can withstand the stress of high-intensity workouts.
- Designed for higher demand tubing exercises that regular tubing just can't keep up with
- Braided tubing provides extra durability, stronger resistance, and faster results

1369603	Medium	\$19.22 EA ★
1369604	Heavy	\$19.22 EA ★



**FITNESS RINGS**

- Rings are molded durable Lexan plastic
- Straps are 1 3/4" wide heavy-duty nylon webbing with leveling markings for quick adjustment
- Includes two 1.1" diameter rings, two 19'L straps with stainless hardware and a carry bag

PMTA1598	\$119.22 PR
----------	-------------





**REACTOR**  
-CHAMPION BARBELL-

**VERTICAL MEDICINE BALL RACK**

- Heavy duty square steel construction with durable black powder coated finish
- Holds 5 balls

1033267 66"H x 16"W x 25"D \$109<sup>99</sup> EA ★



**REACTOR**  
-CHAMPION BARBELL-

**2-SIDED MEDICINE BALL RACK**

- Heavy duty square steel construction with durable black powder coated finish
- Holds 8 balls

1033250 58"H x 24"W x 30"D \$145<sup>99</sup> EA ★



**REACTOR**  
-CHAMPION BARBELL-

**ROLLING MEDICINE BALL RACK**

- 6 tiers, holds 24 medicine balls
- Holds balls up to 16" in diameter
- Silver powder coated finish
- 4 heavy-duty lockable swivel casters

1367628 72"H x 29"W x 29"D \$319<sup>99</sup> EA ★



**SQUARE MEDICINE BALL REBOUNDER**

- Square rebounder that returns balls with speed, force and angle consistent with your throw
- The angle of inclination adjusts from 0-60 degrees
- The 39" diagonal surface measures 27.5" x 27.5"
- Built-in tray to hold balls when not in use

1375497 \$539<sup>99</sup> EA



**MEDICINE BALL REBOUNDER**

- Heavy-duty tubular steel frame with 28" diameter rebound area
- Solid handle with neoprene grip
- Adjustable for different rebound angles
- Built-in tray to hold balls when not in use

1291896 43"H x 40"W x 40"D \$339<sup>99</sup> EA



**MONSTER BALL CART**

- Fabricated from 1" square steel
- Black powder coated finish
- Holds 15 official size basketballs

1162608 30"H x 49"W x 20"D - 30 lbs. \$299<sup>99</sup> EA ★



**FOOTBALL SHAPED HAND-HELD WEIGHT**

- 3 1/2" diameter on all sizes (weights)
- Squeezable, textured rubber cover sand filled weight fits comfortably in the palm of the hand
- Hook and loop strap keeps weight secure to hand and allows for freedom of movement
- Adds resistance while running, doing aerobics or any workout routine

1362190	1 lb. - Light Blue	\$7 <sup>99</sup> EA ★
1362206	2 lb. - Red	\$8 <sup>99</sup> EA ★
1362213	3 lb. - Yellow	\$9 <sup>99</sup> EA ★
1362220	4 lb. - Royal	\$10 <sup>99</sup> EA ★



**HANDHELD FITNESS BALLS**

- Soft, weighted vinyl balls fit comfortably into the palm of the hand
- Incorporate into matwork routines to increase intensity and bring awareness to shoulder girdle stability or target desired muscle groups

1266351	1 lb. - Green	\$9 <sup>99</sup> EA ★
1266368	2 lb. - Red	\$10 <sup>99</sup> EA ★
1266375	3 lb. - Yellow	\$11 <sup>99</sup> EA ★
1266382	4 lbs. - Royal	\$12 <sup>99</sup> EA ★



**SKLZ**  
**CORE WHEELS**

- Develops dynamic core strength
- Ability to tone the muscles of the entire midsection at once from a variety of different angles
- Allows for more push-up variations to target the upper body area
- Improve flexibility through a series of active stretches

1375527

\$49<sup>99</sup> PR



**AB WHEEL**

- Tones and strengthens the abdominals
- Double wheel for added stability

MSABVHLX

\$15<sup>99</sup> EA ★



**REACTOR**  
**AB MAT**

- Abdominal exerciser and core trainer supports lower back for proper positioning
- Safe, comfortable design to help prevent injury
- Designed to take anywhere

1369609

\$25<sup>99</sup> EA



**REACTOR**  
**AB STRAPS**

- Attaches to any pull up bar
- Ideal for training the hard to hit lower abdominals
- Now featuring heavy-duty steel carabiners

1277463

\$38<sup>99</sup> EA



**PEG BOARD CLIMBERS**

- Turn empty walls into active training and testing areas
- Pegboards provide challenge while increasing arm and shoulder strength
- Manufactured of 1 1/2" thick hardwood with clear coat varnish finish
- Comes complete with two hand-grip pegs
- Wall mounting brackets and replacements pegs sold separately

1. 1375518	60"H x 15"W	\$449 <sup>99</sup> EA
2. 1375519	30"H x 30"W	\$449 <sup>99</sup> EA
1375520	Mounting Bracket	\$139 <sup>99</sup> PR
1375521	Replacement Pegs	\$19 <sup>99</sup> PR

**WALL MOUNTED ADJUSTABLE PULL UP BAR**

- Powder coated solid steel bar and frame is adjustable in 6" increments within a 30" range
- Frame attaches to steel stringers and is removable for storage
- Bar is 40"L x 1" O.D. - 29 lbs.
- Stringers are each 54" long with mounting holes 24" apart; mount 37 1/2" center to center
- Attachment hardware not included



1137286

\$224<sup>99</sup> EA ★



**WALL MOUNT MULTI-GRIP PULL UP BAR**

- All steel construction
- Extremely durable powder coated Hammertone Grey finish
- 1 1/4" diameter bar covered with durafoam grips
- Multiple grip positions satisfies all types of pull up exercises
- Mounting hardware not included

1276749

20"H x 50"W x 19"D

\$144<sup>99</sup> EA ★



**NEW!**  
**MULTI-STATION CHINNING BAR**

- 10'L chinning bar with 3 stations
- Mounts 16" away from wall
- 1" solid steel diameter grip with a durable zinc plated finish
- Ideal for mounting fitness rings (see page 268) or other popular suspension training systems

PM00196010

\$524<sup>99</sup> EA



**STROOPS**  
**Slastix® TONER**

- Slastix technology incorporates a Safety Sleeve that encloses latex tubing that protects it from wear, nicks and cuts
- Sleeve also provides safety stretch limitations during resistance training
- 4' long with comfortable handles on each end

1300260	Very Light - Purple	\$18 <sup>22</sup> EA
1301472	Light - Yellow	\$20 <sup>22</sup> EA
1301489	Medium - Red	\$22 <sup>22</sup> EA
1301496	Heavy - Blue	\$24 <sup>22</sup> EA
1301502	Very Heavy - Green	\$26 <sup>22</sup> EA

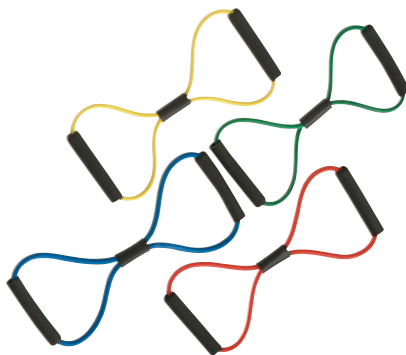

**Quik Fit® TONERS**

- Medical latex tubing offers safe variable resistance and full range of motion muscle conditioning
- The patented figure-eight design offers maximum resistance, while giving you the results you are looking for
- Comfortable foam covered handles
- Choose from 4 levels of resistance

1369503	Very Light - Yellow 3-5 lbs. Resistance	\$6 <sup>22</sup> EA
1369504	Light - Green 6-10 lbs. Resistance	\$7 <sup>22</sup> EA
1369505	Medium - Red 11-15 lbs. Resistance	\$8 <sup>22</sup> EA
1369506	Heavy - Blue 16-22 lbs. Resistance	\$9 <sup>22</sup> EA



**CANDO® EXERCISE TUBES WITH HANDLES**

- Includes comfortable foam covered plastic handles
- Perform lower body, upper body and core conditioning exercises with our multi-use resistance tubes
- Isolate muscles or use as a full range of motion exerciser
- Choose from 5 levels of resistance all are 48" long

1249798	XLight Resistance - Yellow	\$9 <sup>22</sup> EA
1249804	Light Resistance - Red	\$10 <sup>22</sup> EA
1249811	Medium Resistance - Green	\$11 <sup>22</sup> EA
1249828	Heavy Resistance - Blue	\$13 <sup>22</sup> EA
1342574	Extra Heavy Resistance - Black	\$14 <sup>22</sup> EA



CORE



**REACTOR**  
CHAMPION BARBELL  
**BULK FITNESS BANDS**

- 6" W x 150' L latex rolls
- Save money by cutting to desired lengths
- 4 resistance levels for all ages
- Use as a single ply or double up for more resistance

1266528	Pink; Pre-School-Elementary	\$54 <sup>22</sup> ROLL ★
1266535	Green; Intermediate	\$61 <sup>22</sup> ROLL ★
1266542	Purple; High School	\$83 <sup>22</sup> ROLL ★
1266559	Grey; Adult	\$87 <sup>22</sup> ROLL ★

**TUBING HANDLES**

- Pressure-locking system holds tubing in position so you can set the length and control the range of motion
- Switch out tubing for different resistance levels

1279955 \$18<sup>22</sup> PR



**FLAT BAND HANDLES**

- Padded for a comfortable grip
- Simply slide a flat band through the locking bar on the handles and lock securely in position
- Adjust the spacing of the handles- customize the band length

1279962 \$24<sup>22</sup> PR



**REACTOR**  
CHAMPION BARBELL  
**2.5' BULK TUBING**

- Perfect for when you need quality and quantity
- Cuts easily with scissors so you can customize the length to suit your needs
- Handles not included
- Available in 5 resistance levels

1277548	X-Light - Yellow	\$17 <sup>22</sup> EA ★
1277555	Light - Green	\$21 <sup>22</sup> EA ★
1277562	Medium - Red	\$22 <sup>22</sup> EA ★
1277579	Heavy - Blue	\$23 <sup>22</sup> EA ★
1277586	X-Heavy - Black	\$24 <sup>22</sup> EA ★



**STROOPS**  
**Slastix® Pro Power BAND**

- Slastix technology incorporates a Safety Sleeve that encloses the latex tubing to protect it from wear, and provides stretch limitation during training
- The Pro Power Band is two 48" bands attached by a 10" fabric loop that can be attached to virtually any stationary support and 2 handles on either end

1379880	Very Light - Purple	\$36 <sup>22</sup> EA
1379881	Light - Yellow	\$38 <sup>22</sup> EA
1379882	Medium - Red	\$40 <sup>22</sup> EA
1379883	Heavy - Blue	\$42 <sup>22</sup> EA
1379884	Very Heavy - Green	\$44 <sup>22</sup> EA
1379885	Super Heavy - Silver	\$46 <sup>22</sup> EA

**RESISTANCE TUBE STANDING RACK**

- Neatly holds 128 ropes or 40 tubes
- Casters provide easy mobility
- 1.5" square tube construction with white powder coated finish

1281101 60"H x 20"W x 20"D - 25 lbs. \$109<sup>22</sup> EA ★

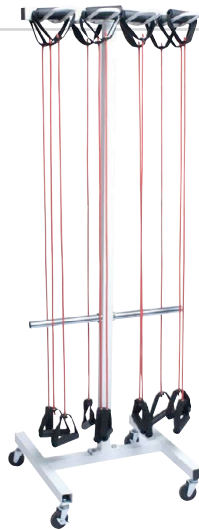

**REACTOR**  
CHAMPION BARBELL  
**BODY LOOP BANDS**

- Closed loop design fits comfortably around the upper and lower legs
- 12" long loops are ideal for short, limited movements
- 22" long loops are suited for more dynamic movements with a greater range of motion

1301694	12" - Extra Light - Yellow	\$4 <sup>42</sup> EA ★
1301700	12" - Light - Orange	\$5 <sup>42</sup> EA ★
1301717	12" - Light/Medium - Red	\$5 <sup>42</sup> EA ★
1301724	12" - Medium - Blue	\$6 <sup>42</sup> EA ★
1301731	12" - Heavy - Green	\$6 <sup>42</sup> EA ★
1301748	22" - Extra Light - Yellow	\$7 <sup>42</sup> EA ★
1301755	22" - Light - Orange	\$9 <sup>42</sup> EA ★
1301762	22" - Light/Medium - Red	\$10 <sup>42</sup> EA ★
1301779	22" - Medium - Blue	\$10 <sup>42</sup> EA ★
1301786	22" - Heavy - Green	\$12 <sup>42</sup> EA ★



**WSU**  
WHILE SUPPLIES LAST

**REACTOR**  
CHAMPION BARRELL

**PEANUT BALL**

- Great for beginning core training
- Oblong design allows for front-to-back and side-to-side patterns only
- Ideal for someone who cannot use a traditional round stability ball

1277142	45 x 90cm - Red	\$29 <sup>99</sup> EA ★
1277166	55 x 100cm - Blue	\$33 <sup>99</sup> EA ★

**STABILITY BALL CART**

- Stores and safely transports stability balls with a diameter of 16" or larger, plus jump ropes, exercise bands and resistance tubes
- Lightweight PVC, yet strong, durable and maintenance free
- Roll lock casters secure cart in place with the push of a lever
- Easily passes through a standard doorway

1257557 67"H x 67"W x 19"D \$279<sup>99</sup> EA



Easily fastens with Velcro

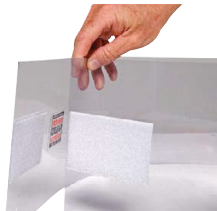

**BALL STORAGE STACKERS**

- Convenient way to store stability balls
- Fasten each stacker with its Velcro attachment to form a circular stacking ring
- Can hold 45cm to 75cm balls

1279887 \$34<sup>99</sup> SET OF 3



**SMART STABILITY BALLS**

- The Smart Stability Balls are self-guided for users at all fitness levels
- 13 exercises are printed on ball for easy reference
- Burst-resistant PVC construction
- Includes pump

1379892	55cm - Yellow	\$31 <sup>99</sup> EA
1379964	65cm - Green	\$34 <sup>99</sup> EA
1379965	75cm - Blue	\$39 <sup>99</sup> EA

**24" BALANCE DISK**

Black Blue Green Red Yellow

- Promotes core stability and provides many of the same benefits of a stability ball while performing lower back and abdominal exercises
- Support and challenge the spinal muscles while enhancing posture
- The tactile surface has been shown to enhance calmness and concentration
- Perform exercises while sitting, kneeling, or lying on top of the disc for dynamic stabilization training
- Inflation requires a standard foot or hand air pump (not included)
- Supports up to 450 lbs.

1377194 Specify Color \$54<sup>99</sup> EA

Black Blue Green Red Yellow

**13" BALANCE DISK**

- Improves coordination, stability, posture and motor skills
- Resembles the sensation of the stability ball and works the core and stabilizer muscles in a more compact environment
- Place them in a chair to help support and challenge the spinal muscles while enhancing posture
- Use two discs for double arm and leg activities such as push ups and squats
- Uses standard needle inflation (pump included)
- Supports up to 350 lbs.

1377189 Specify Color \$24<sup>99</sup> EA





**REACTOR**  
CHAMPION BARRELL

**STABILITY BALL WITH FEET**

- Burst-resistant ball with the addition of small peg feet
- Provides all of the ergonomic seating benefits of a traditional stability ball, but stays put when not in use
- Can also be used on its side like a regular stability ball
- 600 lb. weight limit

1333909	45cm - Light Blue	\$27 <sup>99</sup> EA ★
1333916	55cm - Red	\$29 <sup>99</sup> EA ★
1333923	65cm - Yellow	\$34 <sup>99</sup> EA ★



**BEST SELLER**

**REACTOR**  
CHAMPION BARRELL

**CORE STABILITY BALLS**

- Improve and maintain balance, coordination, posture and flexibility
- Strengthens hard-to-reach muscles often overlooked in normal training
- Use to perform a variety of balance, core, strength, flexibility and rehabilitation exercises
- 600 lb. weight limit

1335873	45cm - Purple	\$18 <sup>99</sup> EA ★
1335880	55cm - Green	\$20 <sup>99</sup> EA ★
1335897	65cm - Yellow	\$24 <sup>99</sup> EA ★
1335903	75cm - Red	\$27 <sup>99</sup> EA ★



CORE



**BODY BALL STRAP WITH HANDLES**

- Helps develop, strengthen, and tone abs, hips, legs, back
- Designed to deliver long-lasting, professional durability
- Effective total body workout that builds strength, burns fat, and improves flexibility and balance
- Accommodates 55 - 75cm stability ball (sold separately)

1369597	55cm	\$19 <sup>99</sup> EA ★
1369598	65 cm	\$20 <sup>99</sup> EA ★
1369599	75 cm	\$21 <sup>99</sup> EA ★



**REACTOR**  
CHAMPION BARRELL

**ANTI-BURST FITNESS BALLS**

- Target abs, back and glutes to strengthen and tone
- Advanced users position the ball for upper and lower body workouts
- Ideal for stretching and warm-up exercises
- Burst resistant up to 600 lbs.

1335910	45cm - Purple	\$28 <sup>99</sup> EA ★
1335927	55cm - Green	\$30 <sup>99</sup> EA ★
1335934	65cm Yellow	\$32 <sup>99</sup> EA ★
1337211	75cm - Red	\$38 <sup>99</sup> EA ★

**WHAT BALL IS RIGHT FOR YOU?**

45CM	=	4'6" TO 5'0"
55CM	=	5'1" TO 5'7"
65CM	=	5'8" TO 6'1"
75CM	=	6'2" AND UP

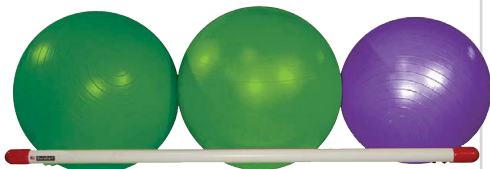

**STABILITY BALL WALL RACK**

- Wall-mounted stability ball rack (hardware not included)
- Conveniently holds 3 medium or 2 large fitness balls

1369556	55"W x 18"D - 6 lbs.	\$69 <sup>99</sup> EA
---------	----------------------	-----------------------

**14" TWO WAY HAND PUMP**

- Works well for larger inflation jobs
- 14" long

1300239	\$9 <sup>99</sup> EA ★
---------	------------------------



**WSU**  
WHILE SUPPLIES LAST

**STRENGTH BALL TRAINING MANUAL**

- Develop strength, power, coordination, balance, and core stability using the medicine ball and stability ball exercises included
- Includes a sample 16-week program with an excellent array of strength, flexibility and balance challenges
- Special Book and DVD package

1236132	\$24 <sup>99</sup> EA
---------	-----------------------

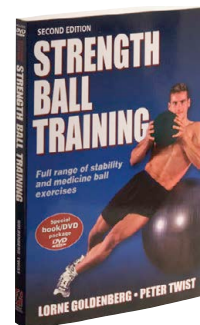

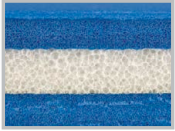
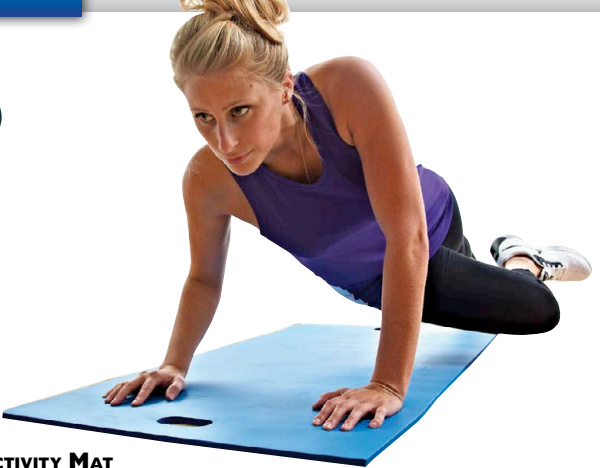

**DUAL DENSITY WORK OUT MAT**

- Extra-tough Polyethylene mat for yoga, pilates, stretching and exercise
- Dual density foam is strong on the inside and soft on the outside
- Cut out carry handle

1271027 48"L x 24"W x 1" \$39<sup>99</sup> EA ★

**ACTIVITY MAT**

- Durable but soft mat with a patented self-sealing foam will not tear, peel or split under normal use
- Mat can be stored flat or rolled up
- Water resistant for easy maintenance and comes with built-in handles

7137XXXX 48"L x 24"W x 3/8" \$20<sup>99</sup> EA ★



2' X 6' FOLDING



**ECONOMY EXERCISE MATS**

- Resilient foam covered with a durable vinyl
- Handles are at each end for easy carrying

GCMAT261 72"L x 24"W x 1" - Folding \$49<sup>99</sup> EA ★  
 GCMAT241 48"L x 24"W x 1" - Non-Folding \$39<sup>99</sup> EA ★

**MAT HANGING CART**

- Durable, PVC cart will transport and store all your lightweight exercise mats with handles
- Holds 36 of our 4'L x 2'W or 18 of our 6'L x 2'W economy exercise mats
- Features (6) locking, swivel casters for added stability
- 40 1/2"H x 25"W x 55"L

1297072 Cart Only \$199<sup>99</sup> EA  
 1299380 Cart + 18 Mats (4' x 2' x 1") \$639<sup>99</sup> PACK ★  
 1299397 Cart + 18 Mats (6' x 2' x 1") \$799<sup>99</sup> PACK ★



**SMART MAT**

- The Smart Mat has 14 Core Exercises printed on one side and 14 Stretching Poses on the other side for easy reference
- The mat features a durable, non-slip surface and is easy to clean
- Includes grommets for easy hanging storage

1379891 72"L x 24"W x 6mm \$54<sup>99</sup> EA



**PACMAT 100**

- Composed of Nitrile™ rubber
- Offers maximum comfort and impact resistance
- The patented cellular foam will not crack, peel or tear under normal use
- Water resistant for easy maintenance

PACMAT 75"L x 24"W x 7/16" \$24<sup>99</sup> EA ★



**PREMIUM EXERCISE MATS**

- Polyfoam filled exercise mats suited for a variety of activities
- Lightweight, durable, virtually maintenance free and are easy to store
- Available in Blue only

**1) Expando Exercise Mat**  
 Folds into 3 sections for easy handling and storage. Size: 72"L x 24"W x 2" thick.

1064870 \$99<sup>99</sup> EA ★

**2) All-Purpose Exercise Mat**  
 Seams are double stitched for added durability. Size: 48"L x 24"W x 2" thick.

1041606 \$79<sup>99</sup> EA ★



**LIGHTWEIGHT & DURABLE!  
 GREAT FOR ALL AGES!**



**HANGING WORKOUT MATS**

• Reinforced grommets allow mats to hang for storage

<b>1277159</b>	48" L x 20.5" W x 3/8" - Red	\$34 <sup>22</sup> EA ★
<b>1277197</b>	72" L x 24" W x 5/8" - Blue	\$54 <sup>22</sup> EA ★

**NEW!**  
**HANGING MAT RACK**

- Height and width adjustments allow this rack to work with different length and width hanging mats
- Constructed of 1.5" and 1.25" square steel tubing with Silver powder coated finish
- Holds up to 50 - 48" or 32 - 72" mats or a combination of both
- Equipped with 4 non-marring polyurethane swivel casters; 2 locking



<b>1378641</b>	Cart Only 74" H x 28" W x 36" L - 39 lbs.	\$199 <sup>22</sup> EA ★
<b>1388485</b>	Cart + 24 Mats (48" L x 20.5" W x 3/8")	\$799 <sup>22</sup> PACK ★
<b>1388486</b>	Cart + 24 Mats (72" L x 24" W x 5/8")	\$1,299 <sup>22</sup> PACK ★



**BEST SELLER**

**RIBBED MULTI-PURPOSE MATS**

- Closed cell foam is great for repelling water or stains
- Hygienic, easy to clean and easily rolled for storage
- Non-slip, hard-wearing and long lasting
- Warm and comfortable to the touch

<b>1022391</b>	56" L x 23" W x 3/4" - Red	\$35 <sup>22</sup> EA ★
<b>1013047</b>	72" L x 39" W x 5/8" - Blue	\$51 <sup>22</sup> EA ★



**YOGA STRAPS**

- Assists with achieving the proper pose or position
- Excellent tool for increasing flexibility
- Buckle allows you to adjust the strap length
- Available in 6' or 8' lengths

<b>1301922</b>	6' Long	\$10 <sup>22</sup> EA
<b>1301939</b>	8' Long	\$12 <sup>22</sup> EA



**AEROBIC MAT**

- The ideal stretching and exercise mat, durable yet soft
- Use for aerobics or under your yoga mat
- Beveled edges have sealed borders on all 4 sides
- Can be rolled for storage
- Black pebble finish

<b>1235005</b>	60" L x 24" W x 3/8"	\$34 <sup>22</sup> EA ★
----------------	----------------------	-------------------------



**YOGA MAT**

- Lightweight, durable sticky mat
- Cushioned non-slip surface
- Hand washable, air dry

<b>1240146</b>	68" L x 24" W x 1/8"	\$18 <sup>22</sup> EA ★
----------------	----------------------	-------------------------



**YOGA BLOCKS**

- For additional support during transitions and poses
- Available in 3" or 4" thickness
- Blue only

<b>1301946</b>	3" Thick	\$14 <sup>22</sup> EA
<b>1301953</b>	4" Thick	\$16 <sup>22</sup> EA



**CAN DO**  
exercise products  
**BALANCE PAD**

- The CanDo Balance Pad combines both exercise and coordination skills
- Widely used for rehabilitation and sports conditioning
- Super soft, closed cell foam pad forces active recruitment of the foot's muscular system, increasing strength, stamina and mobility
- Impervious to water, easy to clean and long-lasting

<b>1388425</b>	20" L x 16" W x 2 1/2" D	\$54 <sup>22</sup> EA
----------------	--------------------------	-----------------------

**NEW!**  
**REACTOR**  
CHAMPION BARBELL  
**BARREL ROLLER**

- This deep tissue roller has a molded plastic core for shape retention and is covered in a multi-textured thick rubber-foam
- The textured surface is great for both myofascial release and knotted-muscle trigger-point relief
- The hard plastic core allows for maximal weight application
- Available in Black only



<b>1388452</b>	5.5" H x 5.5" W x 15" L	\$29 <sup>22</sup> EA
----------------	-------------------------	-----------------------

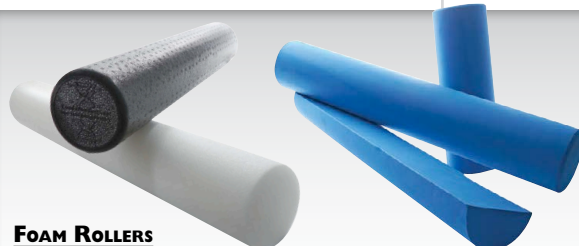

**FOAM ROLLERS**

- Available in 3 firmness levels, medium-firm White PE foam, firm Blue EVA foam, extra-firm Black Molded foam
- Helps develop balance, postural alignment and flexibility
- Ideal for self-myofascial release and massage therapy

<b>1377211</b>	White - 36" x 6" Round - Medium Firm	\$29 <sup>22</sup> EA
<b>1277111</b>	Blue - 36" x 6" Round - Firm	\$43 <sup>22</sup> EA ★
<b>1277128</b>	Blue - 18" x 6" Round - Firm	\$23 <sup>22</sup> EA ★
<b>1277135</b>	Blue - 36" x 3" Half-Round - Firm	\$25 <sup>22</sup> EA ★
<b>1377212</b>	Black - 36" x 6" Round - Extra Firm	\$31 <sup>22</sup> EA



BOSU® BALANCE & STABILITY



**BOSU® PRO TRAINER**

- Targets the core muscles of your body helping you to not only gain strength, trim, and tone, but to help coordinate your entire body
- Ideal for static and dynamic balance training
- Can also be used to integrate balance challenges into cardiovascular, endurance, core and flexibility training
- Can be used with the platform side either up or down to challenge balance with different body positions
- Includes a workout DVD, an inflation pump, a healthy diet guide for weight loss and a 120 page integrated balance training book
- Supports up to 300 lbs.
- 25" diameter x 12"H

**90 Day Limited Warranty**

**1205732** For the Instructor \$219.22 EA

**BOSU® BALANCE TRAINER - PRO BASIC**

- Same as the BOSU Balance Trainer Pro model but with inflation pump only

**1388424** For the student \$189.22 EA



**NEW!**

**BOSU® SPORT**

- New, redesigned smaller version of the original BOSU Balance Trainer and is constructed with the same rim and base style
- The sleek, compact 22" design allows for easy transportation and storage, quick positioning for any type of workout and is ideal for fitness enthusiasts and athletes of all ages
- Includes inflation pump and owners manual
- 250 lbs. maximum user weight

Color Options: **Blue, Pink.**

**1388422** Specify Color \$119.22 EA



**NEW!**

**BOSU® ELITE**

- High density dome for increased power development
- Power Zone training area
- Power Line for precise alignment
- Honeycomb grip and tactile surface
- 400 lbs. maximum user weight
- WeckMethod™ programming

**1388366** \$249.22 EA



**BOSU® POWER STAX**

- BOSU Stax increases the intensity of your workout at different heights
- Creates unlimited options for advanced exercises and explosive power and agility drills
- Each BOSU Stax measures 24"W x 3"H
- BOSU balance trainer sold separately

**1375490** Single \$119.22 EA  
**1375530** Set of 3 \$299.22 SET



**BOSU® TRAINER CLASS PACKAGE**

- Package includes:
- 1 BOSU® PRO Trainer
  - 13 BOSU® PRO Basic
  - 1 BOSU® Storage Cart that holds 14 BOSU® balance trainers

**1257427** \$2,799.22 EA



**BOSU® CART**

- Store up to 14 fully-inflated BOSU® Balance Trainers
- Constructed of durable steel with heavy-duty, non-marking casters for easy portability
- Fits through a standard size door
- 76"H x 25"W x 49.5"L - 271 lbs.

**1257168** \$249.22 EA

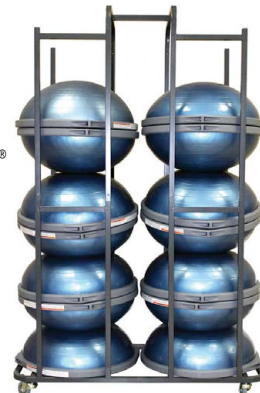



**ADJUSTABLE LATERAL PLYO-BOX**

- Highly durable platform trains explosive lateral movements for strong, quick direction changes
- Quickly adjust sides of platform to 25, 35 or 45 degrees to target all muscles of the ankle, leg and hip
- Reinforced nonslip platforms provide a stable and secure contact area
- Each side holds a 45 lb. weight plate needed for stability (sold separately - see page 239)
- Assembly required



I279917 80"L x 18"W - 83 lbs. \$499<sup>22</sup> EA

**CHAMPION BARBELL. INDIVIDUAL PLYOMETRIC PLATFORMS**

- Constructed of 1" O.D. 16-gauge blue powder coated steel tubing
- Great for improving explosiveness, speed, vertical jump and endurance
- Help minimize muscle strain and injury
- 19" x 19" x 3/4" plywood top covered with heavy-duty non-slip rubber
- For indoor or outdoor use
- Stackable design for easy storage

20023109	9"H	\$129 <sup>22</sup> EA	★
20023112	12"H	\$139 <sup>22</sup> EA	★
20023115	15"H	\$144 <sup>22</sup> EA	★
20023118	18"H	\$149 <sup>22</sup> EA	★
20023124	24"H	\$159 <sup>22</sup> EA	★
20023130	30"H	\$169 <sup>22</sup> EA	★ S&H
20023136	36"H	\$179 <sup>22</sup> EA	★ S&H



**PLYOMETRIC PLATFORM SETS**

I369720	4 pc. Starter Set (9",12",15",18" platforms)	\$444 <sup>22</sup> SET	★ S&H
I369721	4 pc. Intermediate Set (12",15",18",24" platforms)	\$519 <sup>22</sup> SET	★ S&H
I369722	4 pc. Advanced Set (18",24",30",36" platforms)	\$549 <sup>22</sup> SET	★ S&H
I369723	7 pc. Full Set (9",12",15",18",24",30",36" platforms)	\$744 <sup>22</sup> SET	★ S&H

**CHAMPION BARBELL. HEAVY DUTY PLYO BOX SET**

- Set of 4 Plyo Boxes includes one of each: 12", 18", 24" and 30" high
- Stackable for easy storage
- Large 1 1/8" thick non slip landing surface
- Fully welded steel construction with gray powder coated finish
- Floor protectors for indoor or outdoor use
- Can be used by athletes up to 400 lbs.
- Ships fully assembled

I258318 \$844<sup>22</sup> SET ★ S&H

**NEW!**

**FOAM PLYO BOXES**

- Large 30" x 36" landing surface eliminates athlete's fear of missing the box
- Constructed of 100% Naugahyde and premium density polyethylene foam that will not break down, de-laminate or soften over time
- Includes handles, Velcro tabs to secure boxes together and compression vents for air release
- Sold in sets of 3 only: 1 - 6", 1 - 12", 1 - 18"
- Custom color options: Navy, Royal, Light Blue, Dark Green, Kelly, Yellow, Athletic Gold, Orange, Scarlet, Maroon, Purple, White

I382826 BSN Sports - Black \$899<sup>22</sup> SET ★ S&H  
 I378907 Specify Color \$999<sup>22</sup> SET ★ S&H

**ALLOW 3-4 WEEKS FOR CUSTOM COLORS.**



1.



2.



3.

**THE ORIGINAL CLUB STEP**

- The Club Step features a non-slip, 40" x 14" top surface and will support up to 300 lbs.
- The Club High Step features a non-slip, 13" x 9" top surface stackable up to 12.5"H and will support up to 275 lbs.
- The Angled Step Riser is designed specifically for use with the Original Club Step™ and includes a exercise DVD for strength, cardio and interval training programs.

1. 1158656	Club Step	\$129 <sup>22</sup> EA
2. 1377151	High Step	\$99 <sup>22</sup> EA
3. 1256383	Riser Only	\$63 <sup>22</sup> PR

**THE CIRCUIT STEP**

- Adjusts from 4" to 6" to 8" by adding or subtracting the support blocks
- Features a non-slip, 25"L x 11"W top surface
- Each step includes one 4"H platform and four 2"H support blocks
- Will support up to 200 lbs.



1158632 \$75<sup>22</sup> EA

**REACTOR<sup>™</sup>**  
GLAMOURY MARBLES  
**4" AND 6" FITNESS STEPS**

- Constructed of high density polyethylene designed for schools, YMCA's, public recreational and health facilities
- Rounded corners reduce the risk of injury from rough edges
- Additional safety features include non-slip, dimpled top and non-skid bottom with rubber feet
- Top surface area is 24"L x 15"W



1292619	Orange 4" Step	\$25 <sup>22</sup> EA ★
1292626	Grey 6" Step	\$30 <sup>22</sup> EA ★
1292633	10 Pack of Orange 4" Steps	\$239 <sup>22</sup> SET ★
1292640	5 Pack of Grey 6" Steps	\$145 <sup>22</sup> SET ★



**FITNESS STEP CART**

- Large capacity storage rack and transporter for fitness steps and resistance tubes
- Lightweight and durable
- This cart will safely store up to (32) 4" steps or (16) 6" steps plus resistance tubes
- Features include heavy-duty, ball bearing, swivel, non-marring casters with a roll lock feature
- Easily goes through standard doorway

1188332 60"H x 45"W x 19"D \$269<sup>22</sup> EA



**SPRI**  
**STEP360 Pro**

- Versatile balance training device that enhances functional stability
- Provides a safe and superior challenge for all balance, core, range of motion, strength, power, and performance movements through the stabilization and enhancement of 3-D motion
- Designed to enhance the body's ability to react to a more demanding conditioning stimulus, thus heightening its training response

1333961 \$174<sup>22</sup> EA

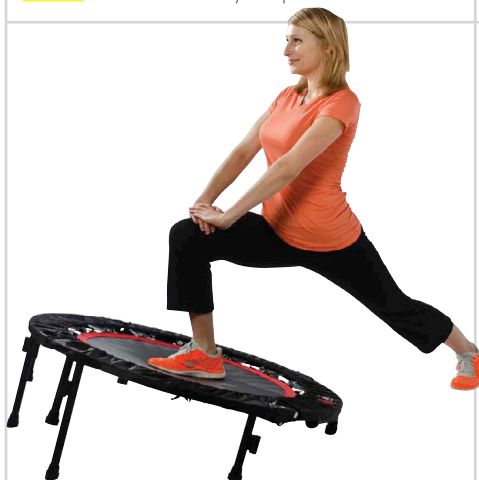

**THE URBAN REBOUNDER**

- 40" Diameter with 32 heavy-duty springs
- Super soft jumping surface and folds for easy storage
- Includes stabilizing bar and workout video
- Strengthens core muscles, improves balance and coordination

1245868 \$224<sup>22</sup> EA



**FREESTYLE CIRCUIT STEP**

- Non-slip surface platform that supports up to 275 lbs.
- 25"L x 11"W stepping surface
- Overall dimensions: 6 1/4"H x 14 1/2"W x 29"L - 9 lbs.
- Includes: (1) Platform, (2) Freestyle Risers and (2) Workout DVDs

1333954 \$69<sup>22</sup> EA



**HEAVYWEIGHT SASH ROPES**

• Thick sash cord jointed into well shaped hollow handles

2546XXXX	8'	\$5 <sup>99</sup> EA ★
2547XXXX	9 1/2'	\$6 <sup>99</sup> EA ★
2548XXXX	16'	\$7 <sup>99</sup> EA ★



**EX-U-ROPES**

- Perfect for beginners or experienced jumpers who want the best
- Great for speed jumping and a favorite with jump teams
- Injection molded handles designed for comfort and free spin
- Durable, plastic rope

17207XXX	Orange 7' Licorice	\$3 <sup>99</sup> EA
17208XXX	Red 8' Licorice	\$4 <sup>99</sup> EA
17209XXX	Green 9' Licorice	\$4 <sup>99</sup> EA
17210XXX	Black 10' Licorice	\$4 <sup>99</sup> EA



**LEATHER JUMP ROPE**

- Ball bearing swivel and foam handles
- 9 1/2' long

2549XXXX	\$17 <sup>99</sup> EA ★
----------	-------------------------



**HEAVY ROPE**

- Filled with sand and made with non-marking rubber
- The weight is distributed proportionately from handle to handle
- Strengthens hand and wrist muscles in addition to being a great cardio workout
- Improves upper and lower arm strength as well as flexibility
- All weights are 8 ft. long

1277647	1 lb.	\$48 <sup>99</sup> EA
1277654	2 lb.	\$53 <sup>99</sup> EA
1277661	4 lb.	\$59 <sup>99</sup> EA
1277678	5 lb.	\$65 <sup>99</sup> EA
1277685	6 lb.	\$71 <sup>99</sup> EA

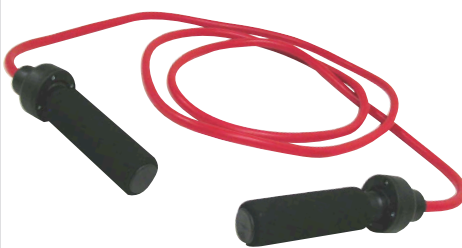

**WEIGHTED JUMP ROPE**

- Durable with padded, swivel handles that allow rope to spin faster, reducing stress on wrists, elbows and shoulders
- 9' length

1024135	1 lb. - Red	\$25 <sup>99</sup> EA ★
1024142	2 lb. - Blue	\$29 <sup>99</sup> EA ★
1024159	3 lb. - Green	\$36 <sup>99</sup> EA ★
1024166	4 lb. - Orange	\$44 <sup>99</sup> EA ★



**NEW!**  
**SKLZ**  
**SPEED ROPE**

- Steel rod and ball bearing system
- Ergonomically designed slim-profile rubberized handles
- Right-angle mounted cord for efficient rotation and proper arm position
- Low-kink, PVC coated 7x7 strand core galvanized steel wire rope
- One-time adjustable length

1386492	\$29 <sup>99</sup> EA
---------	-----------------------



**REACTOR**  
CHAMPION BARRELL  
**AGILITY RINGS**

- 19" diameter rings made of high impact PVC
- Make excellent targets for training sport-specific movements that require technical footwork
- Hook and loop tabs connect rings to create different movement patterns
- Includes carry bag

1375509	\$49 <sup>99</sup> SET
---------	------------------------



**REACTOR**  
CHAMPION BARRELL  
**POWER ROPE ANCHOR STATION**

- Use indoors or outside
- Accommodates up to 12 users at one time
- Solid rubber bottom for floor protection
- Add up to 4 - 45 lb. Olympic weight plates for maximum stability
- All welded, all silver powder coated steel construction
- 6.5"H x 23.5"W x 23.5"D - 32 lbs.
- Power ropes and weight plates sold separately

1375090	\$199 <sup>99</sup> EA ★
---------	--------------------------



**FITNESS POWER ROPES**

- Various length and diameter to enhance the overall work-out experience
- Great for grip strength, stamina and overall conditioning
- Ideal for upper body and core exercises

1369620	1.5"D - 30'L	\$124 <sup>99</sup> EA ★
1369621	1.5"D - 40'L	\$149 <sup>99</sup> EA ★
1369622	1.5"D - 50'L	\$174 <sup>99</sup> EA ★
1369623	1.5"D - 100'L	\$284 <sup>99</sup> EA ★
1369624	2"D - 30'L	\$184 <sup>99</sup> EA ★
1369625	2"D - 40'L	\$224 <sup>99</sup> EA ★
1369626	2"D - 50'L	\$274 <sup>99</sup> EA ★
1369627	2"D - 100'L	\$479 <sup>99</sup> EA ★



**BEST SELLER**

**REACTOR**  
by CHAMPION BARRELL

**QUICK RELEASE TETHER**

- Combines fixed resistance with overload release for explosive speed training
- Partner-activated release frees tether from belt for a burst of speed
- Durable nylon mesh tether features reinforced stitching and a dual grip handles

**1301793** \$49<sup>92</sup> EA

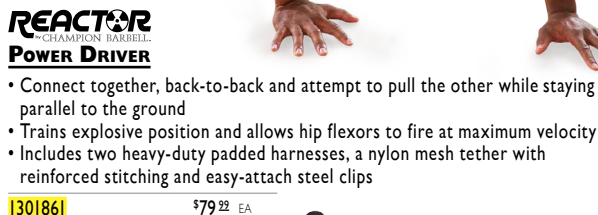

**REACTOR**  
by CHAMPION BARRELL

**POWER DRIVER**

- Connect together, back-to-back and attempt to pull the other while staying parallel to the ground
- Trains explosive position and allows hip flexors to fire at maximum velocity
- Includes two heavy-duty padded harnesses, a nylon mesh tether with reinforced stitching and easy-attach steel clips

**1301861** \$79<sup>92</sup> EA

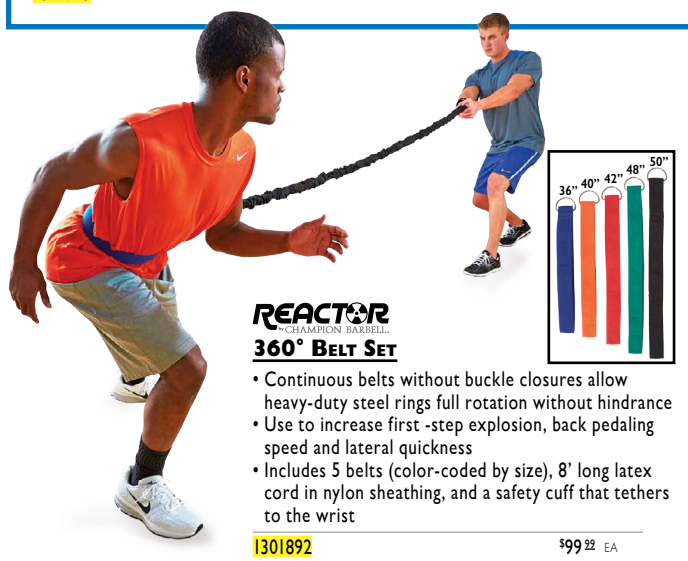

**REACTOR**  
by CHAMPION BARRELL

**360° BELT SET**

- Continuous belts without buckle closures allow heavy-duty steel rings full rotation without hindrance
- Use to increase first-step explosion, back pedaling speed and lateral quickness
- Includes 5 belts (color-coded by size), 8' long latex cord in nylon sheathing, and a safety cuff that tethers to the wrist

**1301892** \$99<sup>92</sup> EA



**REACTOR**  
by CHAMPION BARRELL

**DIRECTIONAL SPEED TRAINER**

- Train powerful lateral movement with dual variable-resistance tethers
- Padded belt with two heavy-duty steel rings allow full range of movement
- Includes safety cuffs that tether to wrist

**1301823** Medium Resistance \$94<sup>92</sup> EA  
**1301830** Heavy Resistance \$99<sup>92</sup> EA



**REACTOR**  
by CHAMPION BARRELL

**SPEED CHUTE**

- Provides excellent resistance while running to improve speed, stamina, strength and acceleration
- Chute releases while running to provide resistance
- Includes carry bag

**1143607** 40" Diameter \$49<sup>92</sup> EA ★  
**1143614** 48" Diameter \$54<sup>92</sup> EA ★  
**1273694** 54" Diameter \$59<sup>92</sup> EA ★

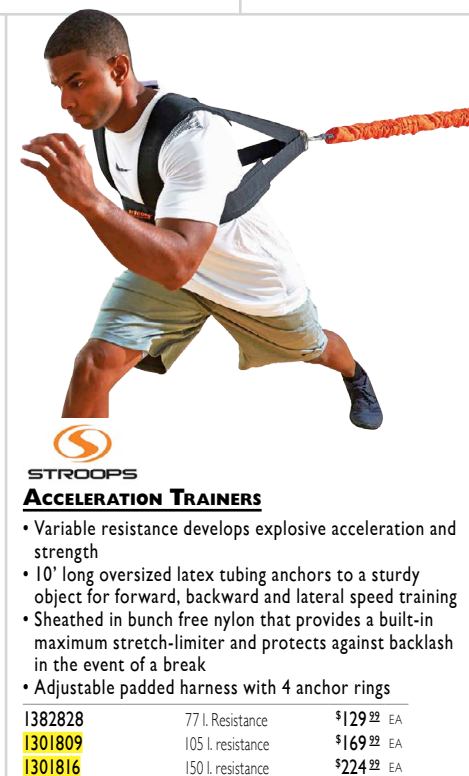

**STROOPS**

**ACCELERATION TRAINERS**

- Variable resistance develops explosive acceleration and strength
- 10' long oversized latex tubing anchors to a sturdy object for forward, backward and lateral speed training
- Sheathed in bunch free nylon that provides a built-in maximum stretch-limiter and protects against backlash in the event of a break
- Adjustable padded harness with 4 anchor rings

**1382828** 77 l. Resistance \$129<sup>92</sup> EA  
**1301809** 105 l. resistance \$169<sup>92</sup> EA  
**1301816** 150 l. resistance \$224<sup>92</sup> EA

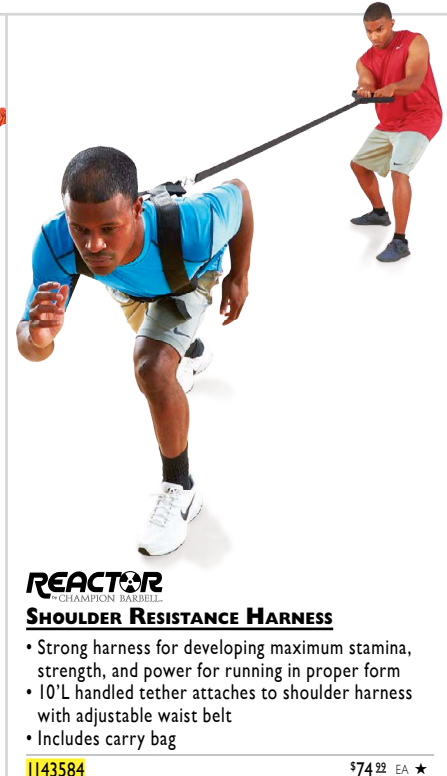

**REACTOR**  
by CHAMPION BARRELL

**SHOULDER RESISTANCE HARNESS**

- Strong harness for developing maximum stamina, strength, and power for running in proper form
- 10'L handled tether attaches to shoulder harness with adjustable waist belt
- Includes carry bag

**1143584** \$74<sup>92</sup> EA ★



### MONSTER SLED

- Ideal for training runs or coach-assisted runs
- 37" W handle to accommodate wide and narrow grips as well as alternate grip positions
- Includes padded shoulder harness for comfort with strong nylon leads
- Two 12" weight posts hold up to 540 l. of Olympic style plates (sold separately - see page 247)
- 32"W x 50"L x 2"H - 90 l.

1301687

\$499<sup>22</sup> EA



### REACTOR<sup>®</sup> CHAMPION BARBELL

#### LOW PUSH/PULL TRAINING SLED

- Increase speed, explosion, leg strength and endurance
- Large radius handle allows for multiple grip locations
- 12"H x 2" O.D. post will hold up to 315 l. of Olympic plates (sold separately - see page 247)
- One piece welded construction, 1.9" silver powder coated steel tubing
- Waist and shoulder harness is fully adjustable with quick release attachment and double safety tethers
- 14"H x 23"W x 38"L - 25 l

1375098

Sled and Harness \$249<sup>22</sup> EA ★

1375084

Sled Only \$209<sup>22</sup> EA ★

1240054

Harness and Tether Only \$44<sup>22</sup> EA ★

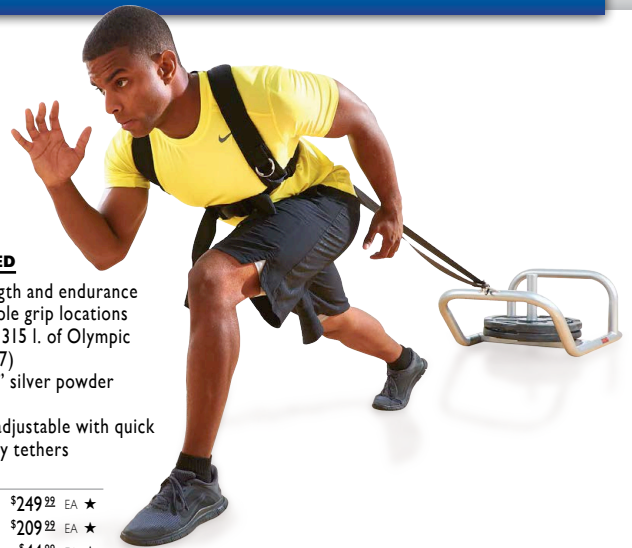

**NEW!**

### SKLZ

#### SPEEDSAC

- Improves speed and explosiveness and strengthens lower-body muscle groups
- Includes 3 durable weight bags than can be filled with up to 10 l. of sand (30 l. total) for variable weight resistance
- Adjustable tether length to accommodate athletes of any size

1386494

\$99<sup>22</sup> EA



### REACTOR<sup>®</sup> CHAMPION BARBELL

#### BLASTER POWER SLED

- Increase speed, explosion, leg strength and endurance
- Made of 11 gauge durable black powder coated steel, skis are 1/4" solid steel
- Closed end rubber grips on low push handles, and capped large push handles accommodate standard 2" Olympic plates (sold separately - see page 239)
- Optional waist and shoulder harness for pull attachment is fully adjustable with quick release attachment and double safety tethers
- 37"H x 46"W x 40"L - 60 l.

1377172

Sled Only \$299<sup>22</sup> EA

1240054

Harness and Tether Only \$44<sup>22</sup> EA ★



### REACTOR<sup>®</sup> CHAMPION BARBELL

#### DUAL RESISTANCE HARNESS

- One athlete provides resistance while the other runs
- Running positions can be alternated quickly for interval training
- Adjustable 3" waist belt
- Includes carry bag

1143591

\$54<sup>22</sup> EA ★



**NEW!**

### POWERMAX

#### PUSH/PULL SLED WITH HARNESS

- Push, pull or sprint your way to more power and speed
- 11 gauge steel frame with space saving design that is only 7" high when folded
- Replaceable/removable runners for use on a variety of surfaces
- Quick release pins for fast set up and breakdown
- Holds up to 300 l. of Olympic style weight plates
- 35"H x 24"W x 35"L - 45 l.

PMTA155

Sled, Harness & Leads \$399<sup>22</sup> EA

PMTA155S04

Replacement Runners \$35<sup>22</sup> EA





**REACTOR**  
BY CHAMPION BARBELL  
**WEIGHT VEST**

- Great for speed and power training
- Secure and comfort fitting straps for maximum movement of your arms, shoulders, and neck
- Adjustable from 1 lb. to 20 l. (weight packs included)

**1369608** 20 l. \$69<sup>99</sup> EA ★



**INFINITY VEST**

- Comfortable form fitting vest
- Breathable design offers adjustable quick release buckles, reflective stripes and a secure pocket for your phone or mp3 player
- Do not machine wash or soak in water
- One size fits most

**1301663** 6 lb. - Blue \$72<sup>99</sup> EA  
**1301670** 10 lb. - Black \$89<sup>99</sup> EA



**NEW!**

**VERSAFIT VEST**

- Padded vest with adjustable hook and loop straps for a secure fit, one size fits most
- Each size comes with the corresponding number of 1 lb. removable sand filled weight bags
- Great for plyometric drills and bodyweight exercises

**1388445** 10 l. \$99<sup>99</sup> EA  
**1388446** 20 l. \$119<sup>99</sup> EA  
**1388447** 40 l. \$159<sup>99</sup> EA



**REACTOR**  
BY CHAMPION BARBELL  
**LATERAL RESISTANCE TRAINER**

- Designed to strengthen the muscles responsible for lateral movement, and designed to teach athletes proper technique
- Adjustable padded ankle cuffs provide a snug comfortable fit
- 17" flexi-cord, available in three resistance levels

**1333879** Light \$32<sup>99</sup> EA  
**1333886** Medium \$32<sup>99</sup> EA  
**1333893** Heavy \$32<sup>99</sup> EA



**SKLZ**  
**RECOIL 360**

- Dynamic Resistance / Assistance Trainer
- Enhance strength & conditioning for sprinting, leaping, shuffling and change of direction.
- Work with a partner or attach the leash to a stationary object

**1364670** \$64<sup>99</sup> EA



**REFLEX BALL**

- Bounces unpredictably when dropped to the ground
- Great for improving hand/eye coordination, balance, quickness and depth perception
- Use in virtually any open space with a flat surface
- Rubber ball - approximately 2.5"- 3" diameter
- Prism pack includes 1 of each color: Blue, Green, Orange, Purple, Red and Yellow

**60500** Yellow \$11<sup>99</sup> EA ★

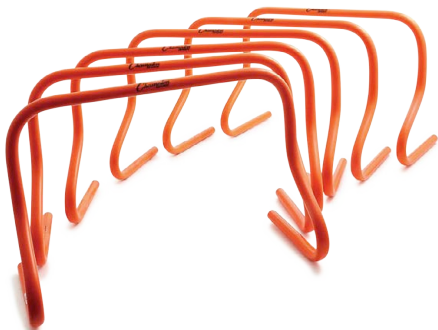

**NEW!**  
**BANANA STEPS**

- Molded tubular PVC construction
- Helps improve quickness and agility
- Designed to absorb impact or fall forward if struck, decreasing the likely hood of training related injuries
- 12"H x 17"W x 8"D
- Sold individually

**1342581** \$9<sup>99</sup> EA



**PORTaPIT**  
**MULTI-HEIGHT FLEX HURDLE**

- Lightweight multi-height flexible PVC hurdle can be converted into two heights 6" or 12" by folding legs in reverse directions
- Helps improve quickness and agility
- Hurdles can be positioned for plyometric jumps or running drills
- Sold in sets of 4

**1202076** \$49<sup>99</sup> SET OF 4 ★



**NEW!**

**SKLZ**  
**6X HURDLE**

- The all purpose hurdle for key performance drills
- Elegant, one piece twist design
- Bounce back construction is virtually indestructible
- Includes six 6" hurdles plus carrying case

**1386490** \$49<sup>99</sup> SET



**NEW!**  
**SKLZ**  
**QUICK LADDER PRO 2.0**

- No webbing means no tangling
- The ultimate in easy set-up, easy carrying training ladders
- Rigid hinged side rails make it easy to fold down
- Durable construction with professional grade materials
- 10'L x 15"W

1386489 \$59<sup>22</sup> EA

**REACTOR**  
CHAMPION BARBELL  
**FIXED RUNG AGILITY LADDER**

- Ideal for developing quick and accurate foot speed, increased balance and coordination
- Each ladder is 15'L x 20"W with ten sections
- Rugged 1" wide webbing with end buckles allow various shape configurations for a more diversified workout
- Connecting buckles allow for additional ladders for longer runs and different formations
- Includes carry bag

1248548 \$44<sup>22</sup> EA ★

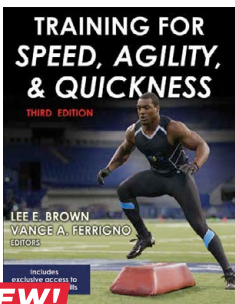

**NEW!**  
**TRAINING FOR SPEED, AGILITY & QUICKNESS**

- The ultimate training resource for improving speed, agility and quickness
- Includes exclusive online access to video library of drills which is ideal for both athletes and coaches
- Allows you to see exactly how to perform key tests and execute the best and most complex drills from the book

1248623 \$27<sup>22</sup> EA



**ROLL OUT AGILITY LADDER**

- Great for ladder drills on indoor or hard flat surfaces
- Spend more time doing drills and less time untangling your ladder
- Made of high quality, durable rubber that will not tear or rip with use

1300246 Single (18"W x 15'L) \$89<sup>22</sup> EA  
1300253 Double (32"W x 15'L) \$155<sup>22</sup> EA

**REACTOR**  
CHAMPION BARBELL  
**DOT DRILL MAT**

- Improve foot speed, reaction time and balance
- Perform multiple footwork patterns
- Cushioned foam rubber construction
- 48 1/2"L x 36"W x 1/2" thick

1301519 \$64<sup>22</sup> EA

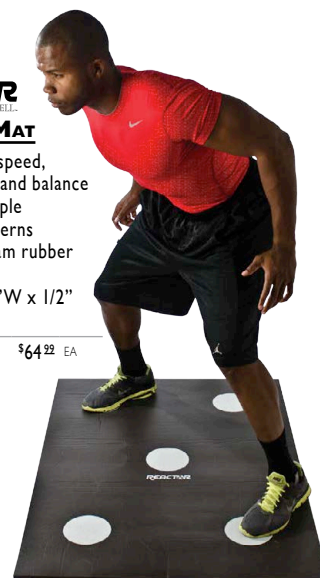

**SMART HURDLES**

- The Smart Hurdle Sets are designed with athletes, coaches and PE teachers in mind and are versatile enough to handle your training needs from agility workouts to over/under drills
- Each hurdle features a sturdy 3-point base that improves stability on all surfaces
- Support leg rotates in either direction and folds flat for storage
- All sets include an easy to use transport handle

1379886 #1 6" - Set of 6 \$99<sup>22</sup> SET  
1379887 #2 12" - Set of 6 \$104<sup>22</sup> SET  
1379888 #3 12" - 18" - Set of 3 \$172<sup>22</sup> SET  
1379889 #4 21" - 36" - Set of 3 \$210<sup>22</sup> SET  
1379890 #5 27" - 42" - Set of 3 \$239<sup>22</sup> SET

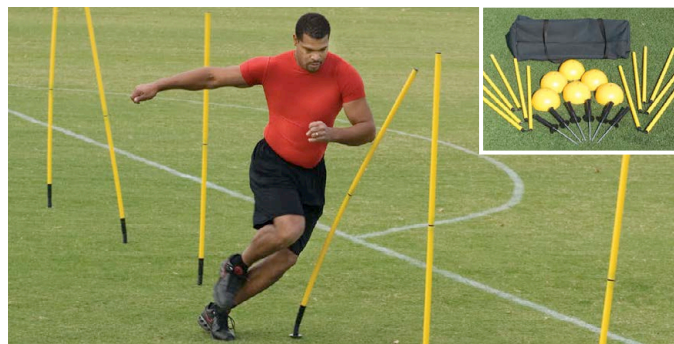

**QUICK THREADED CONNECTIONS SAND WEIGHTED BASES SAFETY SPIKE STORAGE SPRING-LOADED OUTDOOR SPIKE**



**INDOOR/OUTDOOR AGILITY POLE SYSTEM**

- Train athletes to make sharp cuts, maintaining proper form, posture and position
- Reduce reaction time, while improving agility and speed on the field or in the gym
- Includes: (6) 2-piece, 60" PVC poles that break down for easy storage along with (6) spring-loaded spikes for outdoor use and (6) domed bases for drills indoors or on artificial turf
- Bases can be weighted with sand for extra stability

1248555 \$154<sup>22</sup> SET ★



**VERSAFIT LOG**

- Multiple handles and velcro straps allow you to vary exercise focus and function by gripping the bag in different ways
- Use for balance, plyometrics, rotational movements, Olympic lifts, chops and throws
- 23" L x 8" diameter

1301618	10 lb.	\$144 <sup>22</sup> EA
1301625	20 lb.	\$154 <sup>22</sup> EA
1301632	30 lb.	\$164 <sup>22</sup> EA
1301649	40 lb.	\$174 <sup>22</sup> EA
1301656	50 lb.	\$184 <sup>22</sup> EA



**THE TUG**

- Use water for adjustable weight up to 140 lbs; provides a wide variety of activities including tug-of-war, weight training, use as a sled, as an anchor for sit-ups, overhead for lunges, and much more
- Water movement creates inertia that requires compensation for core body work
- 8"H x 30"W x 36"L - 15 lbs. empty
- Color options: Black, Green, Light Blue, Maroon, Orange, Purple, Red, Royal, Yellow



1301908

Specify Color

\$299<sup>22</sup> EA



**WSU**  
WHILE SUPPLIES LAST  
**DOOR GYM**

- Gives you a great upper body workout
- Activates stabilizer muscles to strengthen your core
- Easy to use and secures to virtually any door

1369602 \$39<sup>22</sup> EA ★



**PRO POWER JUMPER**

- Improve jump height and reaction time for better overall performance
  - Unit includes resistance tubing, shoulder harness, 30" x 50" nonslip jumping platform
  - Platform is counter weighted on each side with a 45 lb. weight plate (sold separately - see page 239)
  - Standard length regular tubing for athletes 5'10" and under
  - For indoor use only
- 90 Day Limited Warranty**

1290875

\$499<sup>22</sup> EA ★



**NEW!**  
**SKLZ**  
**SKLZ SUPER SAND BAG**

- Heavy Duty Training Bag
- Increase power & explosiveness
- Great for building total body strength

1364674

\$79<sup>22</sup> EA



# EKHO™ HEART RATE MONITOR SYSTEMS

## EKHO HEART RATE TEAM SYSTEM

### Features Include:

- Real-time Heart Rate
- % of maximum heart rate
- MVPA (Moderate to Vigorous Activity)
- MVPA %
- Target Zone
- Maximum group size: 80 people at one time
- Maximum Range: 100 meters (330 feet)

### EKHO TEAM SYSTEM PACK INCLUDES:

- (1) EKHO receiver pod and USB cable
- (20) EKHO TE-28 transmitter belts with elastic straps
- EKHO software
- User Manual
- (20) replacement batteries
- (20) extra elastic straps
- (1) EKHO storage case
- Heart Education book
- 2-year license



Data displayed on computer or projected on wall for real time heart rate information.

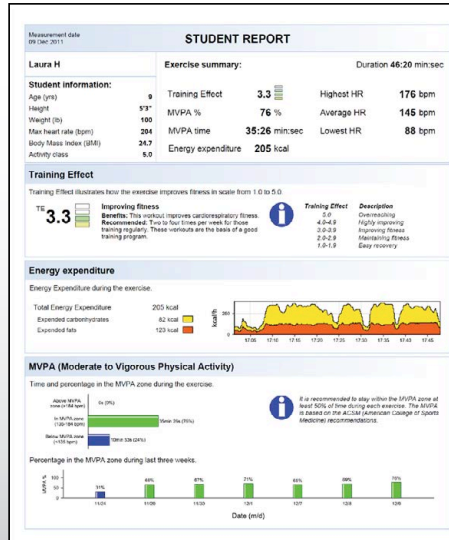

### Customized Student Report provides:

- Max heart rate
- Average heart rate
- Lowest heart rate
- MVPA Time
- Percentage of time in MVPA
- Time in/above/below recall
- Calories burned
- Automatic e-mail reporting
- Pre-profiled transmitter belts
- Real time data collection, no downloading required

### Class Report Provides:

- Class name
- Date of class
- Class size
- Start/end time and duration of class
- Overall class MVPA
- Average class heart rate
- Average class calorie burn
- Customized reports for comments or school logo



Team System Widget



Display heart rates on wall as well as run video or presentation to educate students while they get the best Physical Education experience.

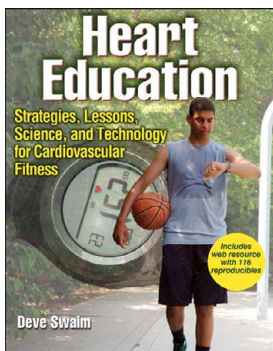

Heart Education Book



EKHO storage case holds 50 EKHO TE-28 transmitters.

### OPTIONS

I377652	System Pack	\$6,749 <sup>25</sup> SET ★
I366474	Transmitter Belt	\$149 <sup>25</sup> EA ★
I366475	Transmitter Belt (10 Pack)	\$1,399 <sup>25</sup> PACK ★
I366476	Transmitter Belt (20 Pack)	\$2,599 <sup>25</sup> SET ★
I366477	Elastic Strap	\$11 <sup>25</sup> EA ★
I377646	Heart Education Book	\$39 <sup>22</sup> EA

EKHO Heart Rate Monitors are **NECESSARY** to comply with NASPE's National Standards for Physical Education.



## POLAR GoFit CLASS HEART RATE MONITOR SYSTEM

Offers individualized heart rate monitoring using the iPad app and H7 Bluetooth Smart Heart Rate Monitors. Serves as a powerful motivation tool for both students and parents. Teachers, parents and students can utilize the polargofit.com web tool, which allows them to track progress and monitor effort throughout the semester. Real-time monitoring of up to (40) students. Range of 40 meters (132 feet). Only works with iPad Generation 3 or newer required (Sold Separately). Annual license required.

### US Games Polar GoFit Class Pack includes:

- 10 ea. H7 Monitors with straps (XS - SM)
- 10 ea. H7 Monitors with straps (MD - XXL)
- 1 ea. Nylon carry case
- 1 ea. Nylon washing pouch
- 1 ea. Nylon storage pouch
- 20 ea. Replacement batteries
- 1 set of Number stickers (1 - 20)
- 3 ea. One-Year licenses

### 2 Year Limited Warranty

1388055 System Pack **\$3,199<sup>99</sup>** SET

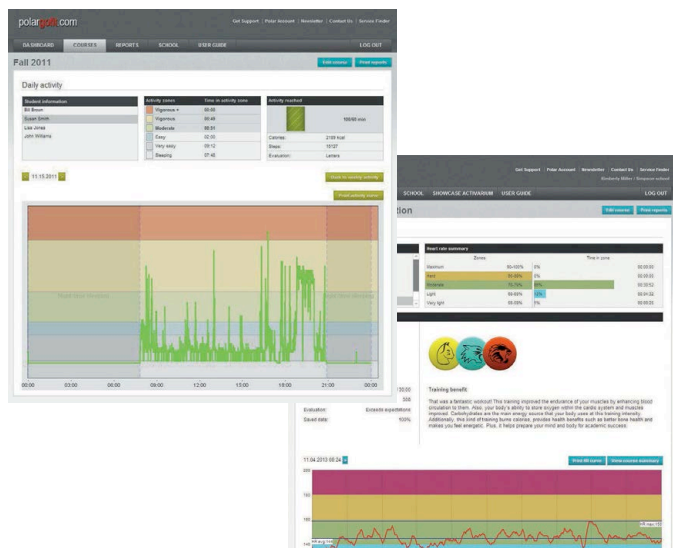

### ADDITIONAL GoFit CLASS ITEMS

1388035	H7 Monitor (Size XS - SM)	<b>\$79<sup>99</sup></b> EA
1388036	H7 Monitor (Size MD - XXL)	<b>\$79<sup>99</sup></b> EA
1388039	Monitor Strap (Size XS - SM)	<b>\$20<sup>99</sup></b> EA
1388040	Monitor Strap (Size MD - XXL)	<b>\$20<sup>99</sup></b> EA
1388043	Battery 10/Pack for HI/H7	<b>\$29<sup>99</sup></b> PACK
1388044	Battery 10/Pack for Actives	<b>\$29<sup>99</sup></b> PACK
1388034	Additional Annual Teacher License	<b>\$199<sup>99</sup></b> EA



## POLAR FT1 HEART RATE MONITOR

Polar FT1 is for simple heart rate training with instant feedback on intensity and calories.

- Shows heart rate on a large easy-to-read display
- Helps improve fitness with manual target zones
- Students can safely exercise within their target zone
- Suitable for swimming
- Includes coded T31C transmitter and elastic strap to be worn around the chest

<b>1307146</b>	Heart Rate Monitor	<b>\$59<sup>99</sup></b> EA
<b>1307184</b>	Replacement Transmitter	<b>\$44<sup>99</sup></b> EA
<b>1307191</b>	Replacement Strap (XS - LG)	<b>\$5<sup>99</sup></b> EA



## POLAR FT7M HEART RATE MONITOR

For those who want to know if they're improving their fitness or burning fat.

- The EnergyPointer displays if the main effect of training is fitness improvement or fat burning
- Displays calories burned
- Comes with comfortable fabric transmitter and coded heart rate transmission to avoid cross-talk
- Suitable for swimming
- Compatible with polarpersonaltrainer.com
- Sync data between the activity monitor and polarpersonaltrainer.com with the OPTIONAL FlowLink USB data transfer unit

<b>1307153</b>	Heart Rate Monitor	<b>\$109<sup>99</sup></b> EA
<b>1307238</b>	FlowLink Interface	<b>\$49<sup>99</sup></b> EA



## POLAR ACTIVE ACTIVITY MONITOR

Designed for teachers/instructors who want to improve the health and fitness of their students through activity training.

- Measures 24/7 daily activity and tracks movement
- Displays steps, calories, time spent in five activity zones and calculates MVPA
- Provides instant activity feedback with an animated figure Compatible with polargofit.com and Activarium
- Sync data between the activity monitor and polargofit.com with the OPTIONAL FlowLink USB data transfer unit

<b>1377070</b>	Black - Adult/Older Youth	<b>\$109<sup>99</sup></b> EA
<b>1377071</b>	White - Womens/Youth	<b>\$109<sup>99</sup></b> EA
<b>1307238</b>	FlowLink Interface	<b>\$49<sup>99</sup></b> EA

## EKHO HEART RATE MONITORS

### WM-28 FLASH

- Includes chest belt transmitter
- Shows zones by flashing colors as well as heart rate number
- Functions include: Current heart rate, Avg. heart rate, Max. heart rate, Out of zone audible & visual alarm, Audible alarm off mode, Time in/above/below target zone recall, Calories burned, Date and time, Stopwatch, Water resistant, Large LCD, ECG accurate

5 Year Limited Warranty

1376369

\$99<sup>25</sup> EA ★

1377234 Class Pack w/Aluminum Case \$2,899<sup>25</sup> PACK OF 30 ★



### E-10

- Includes chest belt transmitter
- Functions include: Current heart rate, Date and Time, ECG accurate, Large display, Water resistant, User changeable batteries

5 Year Limited Warranty

1137477

\$59<sup>25</sup> EA ★

1377224 Class Pack w/Aluminum Case \$1,699<sup>25</sup> PACK OF 30 ★



### WM-25

- Includes chest belt transmitter
- Functions include: Current heart rate, Avg. heart rate, Max. heart rate, Target zone, Out of zone audible & visual alarm, Time In/Above/Below Target Zone recall, Calories burned, Date and Time, Large LCD, ECG Accurate

5 Year Limited Warranty

1202137

\$94<sup>25</sup> EA ★

1377226 Class Pack w/Aluminum Case \$2,699<sup>25</sup> PACK OF 30 ★



### E-15

- Includes chest belt transmitter
- Functions include: Current heart rate, Avg. heart rate, Max. heart rate, Target zone, Out of zone audible & visual alarm, Calories burned, Date and Time, Stopwatch, Large LCD, ECG Accurate

5 Year Limited Warranty

1137484

\$79<sup>25</sup> EA ★

1377225 Class Pack w/Aluminum Case \$2,199<sup>25</sup> PACK OF 30 ★



**WSU!**  
WHILE SUPPLIES LAST

### X5

- Includes coded chest transmitter belt to avoid cross talk
- Functions Include: Continuous, Average, Maximum and Percentage of Maximum Heart Rate; Target and Out-of-Zone Alarm; Time In/Above/Below Target Zone; Calories Burned; Time and Date with backlight; Stopwatch; Water resistant

5 Year Limited Warranty

1376991

\$89<sup>25</sup> EA ★

1376931 Replacement Transmitter \$49<sup>25</sup> EA ★



**NEW!**

### WMP-89

- Strapless! - Transmitter belt not required
- Functions include: Current and average heart rate, percentage of max heart rate and max heart rate during exercise, calorie counter and total fat burn, date and time, lap memory, stop watch, large display with backlight
- Meets NASPE Standards

5 Year Limited Warranty

1388588

\$69<sup>25</sup> EA ★

1388589 Class Pack w/Aluminum Case \$1,849<sup>25</sup> PACK OF 30 ★



### HRM TRANSMITTER AND STRAPS

1376390

Transmitter

\$49<sup>25</sup> EA ★

1376930

Elastic Strap - Specify Size

\$9<sup>25</sup> EA ★

1376393

CR2032 Battery

\$2<sup>25</sup> EA

### DELUXE HEART RATE MONITOR CASE

1257502

\$99<sup>25</sup> EA ★





### PEDOMETER/ACCELEROMETER STORAGE CASE

- Clear plastic storage case
- Holds up to 32 pedometers

**1376395** \$9.95 EA ★



### E-Z ACCESS PEDOMETER STORAGE POCKETS

- Heavy-duty storage system allows students access their pedometers quickly and easily
- Teachers can assign pedometers by number and check inventory instantly
- Durable polyester system features 72 transparent PVC pockets (3 3/4" square) with brass grommets for hanging.
- Pedometers sold separately

**1273526** 39"H x 31 1/2"W \$54.99 EA ★



### YAMAX DIGI-WALKER PEDOMETERS

- World Famous Digiwalker pedometer engine.
- SW-200 Model - Steps ONLY
- SW-801 Model - Steps, Distance, Calories, Speed
- SW-701 Model - Steps, Distance, Calories, Activity Time, Clock, 2 Week Memory

<b>1267242</b>	SW-200	\$26.99 EA
<b>1267259</b>	SW-801	\$35.99 EA
<b>1267266</b>	CW-701	\$43.99 EA



### WALK4LIFE PEDOMETER

Extra large digital display for easy reading. Delayed reset button prevents accidental reset of steps. Durable construction with a hinged protective cover; will hold up in a classroom environment.

- Neo II A - Steps, Activity Time
- Elite A - Steps, activity time, mileage, calories, time of day
- MVP - Steps, activite time, mileage & moderte to vigorous activity time, adjustable steps per minute

1307061	Neo II A - 2 Function	\$24.99 EA
1307078	Elite A - 4 Function	\$27.99 EA
1307085	MVP - 4 Function	\$32.99 EA



### SPORTLINE® 330 ELECTRONIC PEDOMETER

- Ideal for 10,000 steps/day programs
- No adjustment - ready to use
- Large, easy to read display
- Spring loaded belt clip
- Easy reset button
- Battery (LR1142) included
- Detailed instructions and book enclosed

**1237832** \$13.99 EA



### SPORTLINE® 330DS ELECTRONIC PEDOMETER

- Just clip it on and go
- Counts to 1 million steps
- Single axis technology
- Auto-stride length setting
- Single button operation

**1369651** \$15.99 EA



### SPORTLINE® 340DS ELECTRONIC PEDOMETER

- Tracks steps, distance and daily activity time
- Measures distance up to 1,000 miles
- 1/100 mile/km increments
- Single axis technology
- Single button operation
- Allows you to adjust the measurements to fit your personal stride

**1369650** \$18.99 EA



### SPORTLINE® 345 ELECTRONIC PEDOMETER

- Displays distance traveled, steps taken and calories burned
- Distance measured to 1/100 of a mile (.01), steps to 10,000
- Distance and stride sets in MILE (ML) and KILOMETERS (KM)
- Automatic built-in sensitivity adjustment
- Time of day clock

**99345** \$29.99 EA

## EKHO™ PEDOMETERS

### ONE

- Perfect for your 10,000 step per day program.
- Includes: step counter w/extra large digital display, hinged protective cover, loss prevention strap, spring-loaded alligator clip and user changeable battery
- Class Pack option includes: 32 Pedometers, 32 loss prevention straps and 32 unit capacity carrying case

**5 Year Limited Warranty**

**1277210** \$15<sup>25</sup> EA ★  
**1377238** One Class Pack of 32 \$469<sup>25</sup> PACK OF 32 ★



## EKHO™ ACCELEROMETERS

### ONE.5

- No moving parts = no clicking sound
- Tests more accurate than spring-levered and spring-activated pedometers
- Keeps its accuracy even when tilted
- User-friendly and offers greater motivation and goal setting tools for every walker
- Includes: steps, piezoelectric motor, clam shell, alligator clip, loss prevention strap and user changeable battery
- Class Pack option includes: 32 Accelerometers and 32 unit capacity carrying case

**5 Year Limited Warranty**

**1376380** \$24<sup>25</sup> EA ★  
**1377241** Class Pack \$719<sup>25</sup> PACK OF 32 ★



### TWO

- All of the same specifications as the Ekho "One" plus tracks steps and multiplies them by stride length to calculate distance traveled
- Class Pack option includes: 32 Pedometers, 32 loss prevention straps and 32 unit capacity carrying case

**5 Year Limited Warranty**

**1277227** \$16<sup>25</sup> EA ★  
**1377239** Two Class Pack of 32 \$499<sup>25</sup> PACK OF 32 ★



### TWO.5

- All of the same specifications as the Ekho "One.5" plus total steps and activity time
- Class Pack option includes: 32 accelerometers and 32 unit capacity carrying case

**5 Year Limited Warranty**

**1376381** \$27<sup>25</sup> EA ★  
**1377242** Class Pack \$799<sup>25</sup> PACK OF 32 ★



### THREE

- Same specifications as the Ekho "One" and "Two" plus how long it took to get "there" and how many calories burned during your journey
- Class Pack option includes: 32 Pedometers, 32 loss prevention straps and 32 unit capacity carrying case

**5 Year Limited Warranty**

**1277234** \$18<sup>25</sup> EA ★  
**1377240** Three Class Pack of 32 \$529<sup>25</sup> PACK OF 32 ★



### THREE.5

- All of the same specifications as the Ekho "One.5" and "Two.5" plus distance and calories
- Class Pack option includes: 32 accelerometers and 32 unit capacity carrying case

**5 Year Limited Warranty**

**1376382** \$29<sup>25</sup> EA ★  
**1377243** Class Pack \$869<sup>25</sup> PACK OF 32 ★



## BEE-FIT PEDOMETERS



- Meets NASPE Standards
  - Features include: counts steps, extra large digital display, durable construction with hinged cover, loss prevention strap, spring loaded alligator clip and user changeable batteries
  - Worker Bee includes distance, activity time and calories
  - Class Packs include 32 unit carrying case
- 5 Year Limited Warranty**

**1216769** Worker Bee Yellow \$17<sup>25</sup> EA ★  
**1309140** Worker Bee Prism Pack \$99<sup>25</sup> PACK OF 6 ★  
**1377236** Worker Bee Class Pack of 32 \$499<sup>25</sup> PACK OF 32 ★  
**1376373** Busy Bee Yellow \$15<sup>25</sup> EA ★  
**1377237** Busy Bee Class Pack of 32 \$469<sup>25</sup> PACK OF 32 ★



## MVPA ACCELEROMETER

- No moving parts = no clicking sound
- Tests more accurate than spring-levered and spring-activated pedometers
- Keeps its accuracy even when tilted
- User-friendly and offers greater motivation and goal setting tools for every walker
- Includes: steps, distance, calories, exercisetime, MVPA, clock, speed, 7-days memory, piezoelectric motor, clam shell, alligator clip, loss prevention strap, user changeable battery and automatic shut-off when inactive to save battery life

**5 Year Limited Warranty**

**1376383** \$33<sup>25</sup> EA ★  
**1377244** Class Pack \$959<sup>25</sup> PACK OF 32 ★





### 1. BASELINE FLEX TESTER - STANDARD

- Provides the most popular sit and reach test
- Scales printed in inches and centimeters
- For use with any fitness program measuring flexibility including The Presidential Physical Fitness Test, Fitnessgram®, Cooper Institute, YMCA and SHAPE
- Sturdy construction with built-in footplate and maximum stretch indicator that remains until reset
- Assembly required

I375499

\$165<sup>22</sup> EA

### 2. BASELINE FLEX TESTER - DELUXE

Deluxe model offers the same benefits as the Standard model plus the following additional features:

- Used for modified sit-and-reach test enabling the testing protocols to be used that vary the scale starting point
- Adjustable tension reach indicator allows for variations in the length of arms and legs of the person being tested

I375500

\$249<sup>22</sup> EA

### PUSH-UP CHALLENGER

- Provides the teacher and student an effective way to test each individual push up fairly and consistently, while teaching the proper mechanics of the push up
- The student simply touches their chin to the PUSH-UP CHALLENGER, almost guaranteeing their arms are at a right angle
- The push-up tester is now being used by many for Presidential and Fitnessgram tests
- Stackable for easy storage

I377081

\$159<sup>22</sup> DZN ★

### FLEXIBILITY ASSESSMENT TESTER

- Durable, steel construction with non-skid bottom
- For use with The Presidential Physical Fitness Test, Fitnessgram®, SHAPE, Cooper Institute and YMCA programs
- Assembly required

I306316

\$109<sup>22</sup> EA ★

### VERTICAL CHALLENGER

- Telescopes from 4 to 12 feet
- Heavy duty base and casters for stability and portability
- Moveable metal arms placed at 1" increments
- Highest arm reached remains angled until jump reading is measured
- Includes handy reset pole
- Weight plates not included

I245448

\$419<sup>22</sup> EA

### STADI-O-METER

- Lightweight and portable wall mount height measurement rod
- Measures from 30" to 84"
- Easy-slide flip-down measuring arm with analog reading
- Durable steel construction, installs in minutes

I375498

\$119<sup>22</sup> EA

### CARPETED LONG JUMP MAT

- Carpet on top and a non-slip bottom
- Measures long jump distance
- Measures up to 10' in 2" increments

I268928

Carpet size - 12'L x 30"W

\$76<sup>22</sup> EA ★

### MAGNETIC JUMP & REACH BOARD

- Includes two magnets which are placed on board at peak of jump
- Graduations are silk screened on board in 1/2" increments
- Wall mounting hardware not included

G002DXXXX

\$73<sup>22</sup> EA ★



## OMRON Body Fat Analyzer

Measures Body Fat Weight and Percentage with Clinically Proven Accuracy!

- Two modes for accurate results for athletes and non-athletes
- Measurement results in 7 seconds
- Memory settings for 9 personal profiles
- Body mass index reading provides added tracking ability
- Two AAA batteries included

1032338 HBF-306C \$64<sup>22</sup> EA



## BASELINE Economy Body Fat Monitor

Measures Body Fat and Hydration Percentages!

- Measures 4% - 45% body fat and 37.8% - 66% body water with .1% resolution
- 8 person memory
- Adult and child user modes
- Displays in Lbs. or Kgs.
- Includes 2 x 3.0V lithium batteries

1249866 \$25<sup>22</sup> EA



## INSTA PULSE HEART RATE MONITOR

- Unique "Baton" style pulse monitor bar allows an entire class to check pulse rate in a short period of time
- Simply grasp bar, read pulse and pass the baton to the next person
- Standard 9V Battery included
- Waterproof

2217 Monitor Bar Only \$155<sup>22</sup> EA  
 1248470 Stand Only \$219<sup>22</sup> EA ★  
 1245707 Monitor + Stand \$369<sup>22</sup> EA

## SLIM GUIDE SKINFOLD CALIPER

- Only low-cost caliper which meets all of the requirements for jaw pressure and accuracy
- It meets or exceeds specs of the Harpenden and Skyndex units for a fraction of the cost
- Includes instruction booklet

6575XXXX \$25<sup>22</sup> EA



## ACCU-MEASURE FATTRACKER DIGITAL CALIPER

- Automatically calculates and displays body fat %
- No tables and charts to interpret
- Imm accuracy and 100% repeatability
- Audible beep indicates correct pressure and measurement
- Self calibrating for accurate measurements
- Stores 3 personal profiles
- Fitness rating indicator based on gender, age and body fat %
- Includes Myotape® body tape measure

1249842 \$69<sup>22</sup> EA



## OMRON

### 5 SERIES UPPER ARM BLOOD PRESSURE MONITOR

- Two User Modes
- Easy one-touch operation that is both simple and accurate
- Blood Pressure Level Bar indicates if your blood pressure reading exceeds internationally recognized guidelines
- Automatically displays the average of up to the last three readings taken within the last 10 minutes
- Omron's most precise monitor ever
- 50 memory storage capacity for each user (100 total) with date and time stamp
- Detects irregular heartbeats while your blood pressure is being measured
- Removes user errors such as breathing & noise from movement during measurement
- Includes: main unit, wide-ranged-ring cuff (9"-17"), 4 AA batteries, instruction manual and quick start guide
- Limited 2 year warranty

2 Year Limited Warranty

1255812 \$76<sup>22</sup> EA



## WRIST BLOOD PRESSURE MONITOR

- Clinically Proven Accuracy with Smart Measure™ Technology
- One-touch operation for easy use
- Risk Category Index
- 120 Memories / 2 Users
- Date and time stamp
- Memory averaging function
- Batteries and protective plastic storage case are included
- 5 year warranty

1299342 \$49<sup>22</sup> EA

## OMRON. BODY SENSOR BODY COMP MONITOR/SCALE

- Full Body Sensing provides a comprehensive understanding of your body composition to help you reach your fitness goals
- Measures 5 Fitness Indicators: Body Fat Percentage, Body Mass Index (BMI), Skeletal Muscle, Visceral Fat and Body Weight
- Four Person Profile
- 330 lb. capacity
- 4 "AA" batteries included



**1301915** HBF-510W \$109<sup>22</sup> EA

## OMRON. BODY COMPOSITION MONITOR WITH SCALE

- Full Body Sensing provides an accurate comprehensive understanding of your body composition to help you reach your fitness goals
- Measures 7 Fitness Indicators: Body Fat Percentage, Body Mass Index (BMI), Skeletal Muscle, Resting Metabolism, Visceral Fat, Body Age and Body Weight
- 330 lb. capacity
- 4 Person Profile, 90/180 Day Memory, Large LCD display
- 4 "AA" batteries included



**1277722** HBF-516B \$139<sup>22</sup> EA

## EKHO SCALE WITH BODY FAT MONITOR

- Uses a method of Bioelectrical Impedance Analysis (BIA), a highly reliable method of analyzing body composition
- Electrodes in the "foot-pads" send the signal through the body
- Features include: Large, dual display, personal profile set-up and memory, 10 person profile memory, body fat percentage display, measures body fat hydration, muscle and bone and rate graduation of 0.1%
- 396 lb. capacity
- **5 Year Limited Warranty**



**1376389** H-200 \$59<sup>22</sup> EA ★

## BASELINE BODY FAT/ HYDRATION & SCALE

- Measures weight, body fat and water percentage
- 4% - 45% body fat and 37.8% - 66% body water ranges
- 8-person memory
- 330 lbs. maximum capacity
- Adult and child modes
- Requires 9V alkaline battery



**1375488** \$52<sup>22</sup> EA

## **NEW!** PS-6600ST PORTABLE SCALE

- Compact, portable and battery operated
- Quick and accurate +/- 0.1 lb
- 16" x 18" x 1-3/4" platform
- 500 lb. weight capacity; weighs in lbs or kg
- Plug & Weigh with auto-zero and 4-minute auto-off function
- Super Tuff one-piece cast aluminum construction
- Dual power via rechargeable batteries or AC plug-in adapter
- Made in the U.S.A.



1384368 Scale & Console \$639<sup>22</sup> EA  
1384376 Hard-Shell Carry Case \$249<sup>22</sup> EA  
1384377 Soft-Sided Carry Case \$89<sup>22</sup> EA

## **NEW!** PS-5700 PORTABLE SCALE

- Compact, portable and battery operated
- 13" x 13" x 2" platform
- 500 lb. weight capacity; weighs in lbs or kg
- Programmable settings include auto-off time, always-on option, audible beep
- Plug & Weigh with weight recall and reweigh functions
- MotionLock Technology accurately weighs unsteady users
- Durable all-metal construction; uses 6 C-cell batteries
- Made in the U.S.A.

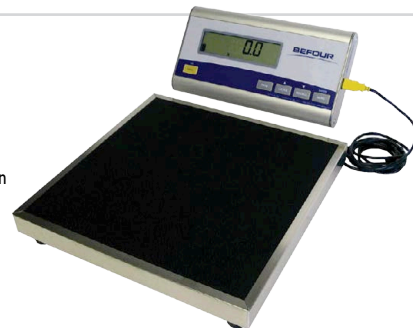

1384366 Scale & Console \$659<sup>22</sup> EA  
1384378 Hard-Shell Carry Case \$249<sup>22</sup> EA  
1384377 Soft-Sided Carry Case \$89<sup>22</sup> EA

## EKHO P-900 PULSE OXIMETER

- Measures Oxygen Saturation (SpO2)
- Measures Pulse Rate (PR)
- Real Time Pulse Bar Display
- Automatic Power Off
- Bright 0.95 Monochrome OLED Display
- Small/Lightweight
- For sports use only
- **5 Year Limited Warranty**



**1376387** \$59<sup>22</sup> EA ★



## EKHO P-950 PULSE OXIMETER

- Measures Oxygen Saturation (SpO2)
- Measures Pulse Rate (PR)
- Real Time Pulse Bar Display
- Automatic Power On
- Automatic Power Off
- Switchable to PI (Perfusion Index) %
- Beep Alarm for Abnormal Readings
- Bright 0.95 Monochrome OLED Display
- 2 Direction Switchable Display
- Small/Lightweight
- For sports use only
- **5 Year Limited Warranty**



**1376388** \$79<sup>22</sup> EA ★





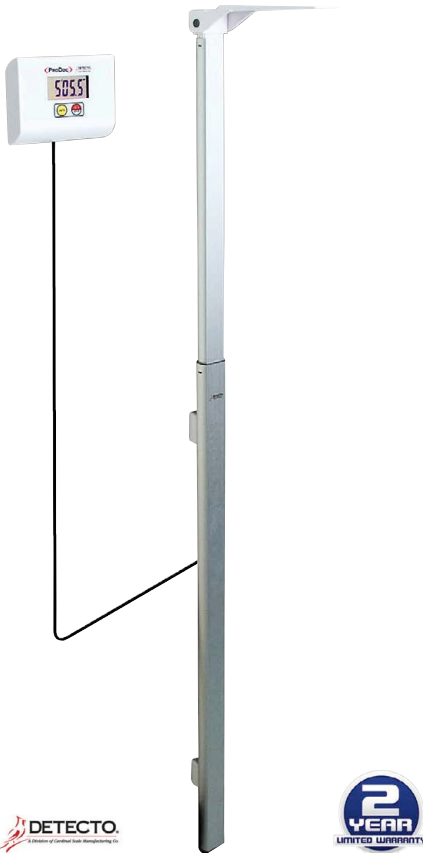

DETECTO  
A Division of Cardinal Scale Manufacturing Co.



### WALL-MOUNT DIGITAL HEIGHT ROD

- Fast, accurate digital height LCD readouts
- Modern, clean design
- Display can be mounted on wall or desk
- View height in inches or centimeters
- Measures from 3' 7" to 6' 7"

**2 Year Limited Warranty**

1292701

\$289<sup>22</sup> EA



DETECTO  
A Division of Cardinal Scale Manufacturing Co.



### PHYSICIAN'S SCALE

- Features a height rod in inches and centimeters, from 30" to 78" (76cm to 198cm).
- Platform cover is easily removed for cleaning.
- Die-cast beam can be easily read from either side.
- 400 lb. capacity.
- Heavy duty understructure.
- Every Detecto physician scale features a time-honored reputation for rigid construction and precision engineering.

**2 Year Limited Warranty**

1077858

#439

\$319<sup>22</sup> EA



DETECTO  
A Division of Cardinal Scale Manufacturing Co.



### DIGITAL SCALE

- The heavy-duty understructure of this digital eye-level scale incorporates a fabricated lever system that is enhanced by precision-ground, pressed-in knife edges which eliminate friction.
- Features "at a glance" convenience w/battery powered LCD display.
- The height rod is graduated in both inches and centimeters.
- Display functions include auto off/release of display, automatic zero and motion detection.
- Readings appear in pounds or kilograms.
- Also features BMI calculation.
- NTEP Certified - 500lb capacity
- Requires 6 "C" batteries, not included.

**2 Year Limited Warranty**

1257519

#6439

\$1,299<sup>22</sup> EA



DETECTO  
A Division of Cardinal Scale Manufacturing Co.



### PRO DOC DIGITAL SCALE

- Can weigh up to 480 lbs.
- Easy-to-view LCD display with 1" high digits
- Adjustable locking feet and bubble level for accuracy
- Selectable sleep mode and auto shut-off mode to help save battery life and electricity
- Available with 48" comfort-height display and built-in wheels or low profile version with wall/desk mount bracket for LCD display
- Powered by 6 "AA" batteries (not included) or by optional 9V AC/DC Power Adapter (sold separately)

**2 Year Limited Warranty**

1298734

PD300 - With Display Stand

\$489<sup>22</sup> EA

1298710

PD100 - Without Display Stand

\$449<sup>22</sup> EA

1298727

Carrying Case for PD100/PD150

\$79<sup>22</sup> EA

1335828

9V AC/DC Adapter

\$65<sup>22</sup> EA



DETECTO  
A Division of Cardinal Scale Manufacturing Co.



### SLIMPRO LOW-PROFILE DIGITAL SCALE

- Digital 1.4" high low-profile scale with 17" x 14.5" platform
- LCD Screen with large 1.5" high digits and 5-second weight hold
- 440-lb capacity with accuracy of 0.2 lbs
- Built-in carrying handle for portability
- Foot pads for weighing on any surface (even carpets)
- 4 AAA batteries (included) with auto On/Off
- RS232 serial port for use with optional P50 thermal tape printer or EMR/EHR software

**2 Year Limited Warranty**

1384312

\$139<sup>22</sup> EA



DETECTO  
A Division of Cardinal Scale Manufacturing Co.

### PORTABLE FLOOR SCALE

- Low profile design, heavy duty mechanical construction and a non-skid vinyl mat
- The large diameter dial allows for easy readability even for tall people
- Designed for personal use, fitness centers, and health care facilities
- 300 lb. capacity
- Overall dimensions: 2.5"H x 12"W x 16.75"D - 9 lbs.
- Platform dimensions: 11.25"W x 11.75"D

**2 Year Limited Warranty**

1292725

D1130

\$89<sup>22</sup> EA





**BONDED-FOAM MATS**  
**Firmer Than Polyfoam Mats, But Softer Than Polyethylene Mats!**







- Perfect for tumbling, exercise, play and low impact gymnastics by elementary and middle school age children
- Top quality 2" thick bonded foam mat designed for comfort and moderate support
- Nylon reinforced tough 18 oz. vinyl cover uses double reinforced, nylon stitched inverted seams to create a smooth working surface
- Mats have 2' panels and folds

**4' X 8' MAT SHOWN**



**TOP QUALITY 2" THICK BONDED FOAM**

**24 HOUR Quick Ship! Royal Mats**

Specify Color(s) when ordering!

CODE	MAT SIZE	PANEL SIZE	HOOK & LOOP FASTENER OPTIONS			ROYAL MATS	COLOR MATS	DELIVERY
			NONE	ENDS ONLY	ALL SIDES	PRICE	PRICE	
1280876	4' x 6'	2'	X			\$199 <sup>22</sup>	\$199 <sup>22</sup>	
1280807	4' x 8'	2'	X			\$219 <sup>22</sup> ★	\$239 <sup>22</sup> ★	
1280814	5' x 10'	2'	X			\$319 <sup>22</sup> ★	\$339 <sup>22</sup> ★	
1280821	6' x 12'	2'	X			\$519 <sup>22</sup> ★	\$539 <sup>22</sup> ★	
1044218	4' x 6'	2'		X		\$209 <sup>22</sup> ★	\$219 <sup>22</sup> ★	
1041903	4' x 8'	2'		X		\$269 <sup>22</sup> ★	\$289 <sup>22</sup> ★	
1041927	5' x 10'	2'		X		\$409 <sup>22</sup> ★	\$429 <sup>22</sup> ★	
1041941	6' x 12'	2'		X		\$559 <sup>22</sup> ★	\$579 <sup>22</sup> ★	
1044225	4' x 6'	2'			X	\$249 <sup>22</sup> ★	\$249 <sup>22</sup> ★	
1041484	4' x 8'	2'			X	\$289 <sup>22</sup> ★	\$309 <sup>22</sup> ★	
1041507	5' x 10'	2'			X	\$419 <sup>22</sup> ★	\$439 <sup>22</sup> ★	
1041521	6' x 12'	2'			X	\$579 <sup>22</sup> ★	\$599 <sup>22</sup> ★	

### WHICH MAT IS RIGHT FOR YOU?

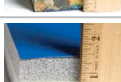
	FOAM	FIRMNESS	ABSORPTION	RECOMMENDED USAGE
	2" Polyfoam	Soft	Low	Low-impact activities with very young children
	2 3/8" Combo Foam	Semi-Soft	Medium	Medium-impact activities with young children
	2" Bonded Foam	Semi-Firm	Medium	Medium-impact activities with older children. Perfect for tumbling, exercise, play and low impact gymnastics.
	1 3/8" Polyethylene	Firm	High	High impact activities by older and heavier users. Use in physical education, gymnastic classes, cheerleading and martial arts training and more.



**ALUMINUM WALL MOLDING STRIPS**

- Attach permanently to wall for hanging mats with fasteners on 4 sides
- 2" wide hook and loop fastener strip holds mats to wall
- Sold in 6' sections

1044782 Specify Hook or Loop Fasteners \$59<sup>99</sup> SET



**ULTIMAT<sup>®</sup>**

**Our Firmest and Lightest Mat!**

- Provides firm support for high impact activities
- Use in physical education and gymnastic classes, cheerleading and martial arts training and more
- 1 3/8" firm cross-linked foam covered in tough 18 oz. vinyl
- Cover resists abrasions, tears, fungus and mildew
- Mats have 2' panels and folds



5' X 10' MAT SHOWN

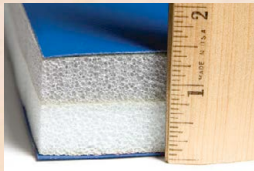

**1 3/8" CROSS LINKED POLYETHYLENE FOAM**



Specify Color(s) when ordering!

CODE	MAT SIZE	HOOK & LOOP FASTENER OPTIONS			ROYAL MATS	COLOR MATS	DELIVERY
		NONE	ENDS ONLY	ALL SIDES	PRICE	PRICE	
1280838	4' x 6'	X			\$189 <sup>99</sup> ★	\$209 <sup>99</sup> ★	
1280845	4' x 8'	X			\$239 <sup>99</sup> ★	\$259 <sup>99</sup> ★	
1280852	5' x 10'	X			\$369 <sup>99</sup> ★	\$389 <sup>99</sup> ★	
1280869	6' x 12'	X			\$479 <sup>99</sup> ★	\$499 <sup>99</sup> ★	
1257915	4' x 6'		X		\$209 <sup>99</sup> ★	\$219 <sup>99</sup> ★	
1041880	4' x 8'		X		\$259 <sup>99</sup> ★	\$279 <sup>99</sup> ★	
1041965	5' x 10'		X		\$389 <sup>99</sup> ★	\$409 <sup>99</sup> ★	
1041989	6' x 12'		X		\$489 <sup>99</sup> ★	\$509 <sup>99</sup> ★	
1257922	4' x 6'			X	\$219 <sup>99</sup> ★	\$239 <sup>99</sup> ★	
1041545	4' x 8'			X	\$269 <sup>99</sup> ★	\$289 <sup>99</sup> ★	
1041569	5' x 10'			X	\$399 <sup>99</sup> ★	\$419 <sup>99</sup> ★	
1041583	6' x 12'			X	\$489 <sup>99</sup> ★	\$509 <sup>99</sup> ★	

**COLOR CHOICES: Choose from 14 school colors, in solids or alternating panel colors.**

Due to dye lots and natural variations, vinyl colors may vary slightly if ordered at separate times.

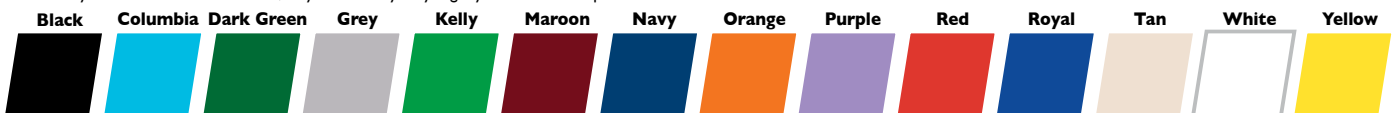



## EXPANDO SUPERNOVA MATS

**Our Softest Mat for Low Impact Activities With Very Young Users!**

- Perfect for teaching basic gymnastics and exercises to children ages 3-9
- So light young children can move and store them
- Nylon reinforced tough 18 oz. vinyl cover uses double reinforced, nylon stitched inverted seams to create a smooth working surface
- Mats have 2' panels and folds
- **Fasteners on Ends Only**



CODE	MAT SIZE	ROYAL MATS	COLOR MATS	DELIVERY
		PRICE	PRICE	
1058277	4' x 6'	\$229 <sup>22</sup> ★	\$249 <sup>22</sup> ★	
1051476	4' x 8'	\$269 <sup>22</sup> ★	\$289 <sup>22</sup> ★	
1051483	5' x 10'	\$419 <sup>22</sup> ★	\$439 <sup>22</sup> ★	
1051490	6' x 12'	\$549 <sup>22</sup> ★	\$569 <sup>22</sup> ★	

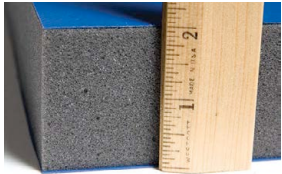

**2" 100 ILD POLYFOAM**



**4' X 8' MAT SHOWN**

Specify Color(s) when ordering!



## RAINBOW MATS

**One Foot Panels and 18 oz. Vinyl!**

- Available with your choice of 1 3/8" cross-linked polyethylene (firmer for high impact activities) and 2" polyfoam fillers (softer for young users and low impact activities)
- Each 1' panel is covered with a different color of nylon reinforced 18 oz. vinyl
- Mats have 1' panels and 2' folds
- 1' panel mats lie flatter than 2' panel mats
- **Fasteners on Ends Only**

**4' X 8' MAT SHOWN**



Cross Linked Polyethylene Foam				
CODE	MAT SIZE	PANEL SIZE	PRICE	DELIVERY
1153521	4' x 6'	1'	\$199 <sup>22</sup> ★	
1153538	4' x 8'	1'	\$249 <sup>22</sup> ★	
1041644	5' x 10'	1'	\$359 <sup>22</sup> ★	
Polyfoam				
1153545	4' x 6'	1'	\$209 <sup>22</sup> ★	
1153552	4' x 8'	1'	\$259 <sup>22</sup> ★	



**1 3/8" CROSS LINKED POLYETHYLENE FOAM**

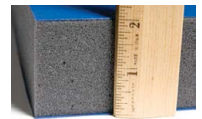

**2" POLYFOAM**

**COLOR CHOICES:** Choose from 14 school colors, in solids or alternating panel colors. Due to dye lots and natural variations, vinyl colors may vary slightly if ordered at separate times.

**Black**

**Columbia**

**Dark Green**

**Grey**

**Kelly**

**Maroon**

**Navy**





**EXPANDO NOVA DUO  
LAYERED-FOAM MATS**

Combines the Soft Cushion of Polyfoam with the Firm "no bottoming" Trait of Polyethylene!

- Perfect for young, beginner or intermediate tumblers
- A 1" layer of polyfoam provides the softness for younger, lightweight children, while a firmer 1 3/8" polyethylene layer keeps the mat from "bottoming out" during more extensive use
- Nylon reinforced tough 18 oz. vinyl cover uses double reinforced, nylon stitched inverted seams to create a smooth working surface
- Mats have 2' panels and folds and are lightweight for easy handling and storage
- **Fasteners on ends only**

**1" POLYFOAM LAYER AND  
A FIRMER 1 3/8"  
POLYETHYLENE LAYER**

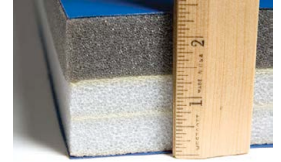

CODE	MAT SIZE	ROYAL MATS	COLOR MATS	DELIVERY
		PRICE	PRICE	
1044256	4' x 6'	\$269 <sup>22</sup> ★	\$289 <sup>22</sup> ★	
1041781	4' x 8'	\$339 <sup>22</sup> ★	\$359 <sup>22</sup> ★	
1041828	5' x 10'	\$509 <sup>22</sup> ★	\$529 <sup>22</sup> ★	
1041842	6' x 12'	\$619 <sup>22</sup> ★	\$639 <sup>22</sup> ★	

**5' X 10' MAT SHOWN**  
Specify Color(s) when ordering!



- MAT TAPE**
- Easy to use and remove
  - Will not stretch out
  - Secures overlaps

6411XXXX	3" x 84'	\$13 <sup>22</sup> ROLL ★
6406XXXX	4" x 84'	\$14 <sup>22</sup> ROLL ★

**MAT CART**

- A durable, PVC mat truck transports and stores mats of all sizes
- Lightweight cart is easily maneuvered by one person
- The convenient handle folds flat for easy storage
- Some assembly required

1246155 7"H x 22"W x 66"L \$219<sup>22</sup> EA

**EXPANDO MAT TRUCK**

- Transport your folding and non-folding mats up to 6' x 12'
- Features a galvanized steel tube frame with plywood base covered in carpet
- The large handle and 4 swivel casters makes it easy to maneuver

MTTRUCK 2'W x 6'L \$399<sup>22</sup> EA





- New GREEN patented foam product
- Made from 60% recycled and 40% virgin polyester fiber
- Safer for environment than other foams
- 100% toxin and latex free
- Mold and mildew proof
- 18 oz. PVC coated vinyl covering
  - Fire retardant California 117 T.B.
- 2' panels and 2' folds

## ADVANTAGES

FEATURE	ENVIROSAFE	URETHANE/POLY FOAMS
100% Toxin Free	<b>YES</b>	<b>NO</b>
Zero VOC's or Off Gas	<b>YES</b>	<b>NO</b>
Hypoallergenic	<b>YES</b>	<b>NO</b>
Latex Free	<b>YES</b>	<b>NO</b>
Fire Retardant Calif 117T.B.	<b>YES</b>	<b>NO</b>
Mold & Mildew Proof	<b>YES</b>	<b>NO</b>
100% Recyclable	<b>YES</b>	<b>NO</b>
No Leachable Chemicals	<b>YES</b>	<b>NO</b>



**4 FOAM CHOICES**



**EXCELLENT  
CUSHION  
RESISTANCE**

### 1 1/2" THICK EXTRA FIRM

Fasteners On Ends Only

1289275	4' x 6' x 1 1/2"	\$244 <sup>EA</sup>
1289558	4' x 8' x 1 1/2"	\$306 <sup>EA</sup>
1289831	5' x 10' x 1 1/2"	\$459 <sup>EA</sup>
1290110	6' x 12' x 1 1/2"	\$599 <sup>EA</sup>

### 2" THICK SOFT ILD 100

Fasteners On Ends Only

1287035	4' x 6' x 2"	\$234 <sup>EA</sup>
1287318	4' x 8' x 2"	\$295 <sup>EA</sup>
1287592	5' x 10' x 2"	\$439 <sup>EA</sup>
1287875	6' x 12' x 2"	\$612 <sup>EA</sup>

### 2" MEDIUM FIRM

Fasteners On Ends Only

1288155	4' x 6' x 2"	\$224 <sup>EA</sup>
1288438	4' x 8' x 2"	\$285 <sup>EA</sup>
1288711	5' x 10' x 2"	\$439 <sup>EA</sup>
1288995	6' x 12' x 2"	\$612 <sup>EA</sup>

### 2 1/2" THICK EXTRA FIRM/SOFT COMBO

Fasteners On Ends Only

1285710	4' x 6' x 2 1/2"	\$307 <sup>EA</sup>
1285994	4' x 8' x 2 1/2"	\$379 <sup>EA</sup>
1286274	5' x 10' x 2 1/2"	\$549 <sup>EA</sup>
1286557	6' x 12' x 2 1/2"	\$704 <sup>EA</sup>

### 1 1/2" THICK EXTRA FIRM

Fasteners On All 4 Sides

1289411	4' x 6' x 1 1/2"	\$265 <sup>EA</sup>
1289695	4' x 8' x 1 1/2"	\$336 <sup>EA</sup>
1289978	5' x 10' x 1 1/2"	\$509 <sup>EA</sup>
1290257	6' x 12' x 1 1/2"	\$652 <sup>EA</sup>

### 2" THICK SOFT ILD 100

Fasteners On All 4 Sides

1287172	4' x 6' x 2"	\$264 <sup>EA</sup>
1287455	4' x 8' x 2"	\$326 <sup>EA</sup>
1287738	5' x 10' x 2"	\$469 <sup>EA</sup>
1288018	6' x 12' x 2"	\$652 <sup>EA</sup>

### 2" MEDIUM FIRM

Fasteners On All 4 Sides

1288292	4' x 6' x 2"	\$254 <sup>EA</sup>
1288575	4' x 8' x 2"	\$316 <sup>EA</sup>
1288858	5' x 10' x 2"	\$469 <sup>EA</sup>
1289138	6' x 12' x 2"	\$642 <sup>EA</sup>

### 2 1/2" THICK EXTRA FIRM/SOFT COMBO

Fasteners On All 4 Sides

1285857	4' x 6' x 2 1/2"	\$327 <sup>EA</sup>
1286137	4' x 8' x 2 1/2"	\$399 <sup>EA</sup>
1286410	5' x 10' x 2 1/2"	\$569 <sup>EA</sup>
1286694	6' x 12' x 2 1/2"	\$724 <sup>EA</sup>

**COLOR CHOICES: Choose from 14 school colors, in solids or alternating panel colors.**

Due to dye lots and natural variations, vinyl colors may vary slightly if ordered at separate times.



# DOLLAMUR

SPORT SURFACES



### FLEXI-ROLL® CARPET/FOAM FLOOR

- The strongest carpet in the gymnastics industry, yet soft like velour
- Rolls are lightweight and designed for performance and easy set up and storage
- Manufactured with closed-cell, cross-linked polyethylene foam, renowned for its shock absorption and resiliency
- Our foam layers are heat laminated to our famous needle punch carpet for outstanding durability and non-slip traction
- The bond between the carpet and foam is critical
- During manufacturing, the surface of the foam is liquefied and then cooled, the carpet and foam substrates actually become one piece, creating a permanent, virtually indestructible bond
- The floor consists of 7 rolls 6' x 42' x 1 3/8" which combine to create a 42' square surface
- Purchase all 7 rolls together or buy them individually as your budget allows to build an entire floor
- Each roll includes one roll of 4" Velcro®

I048148FR	42' x 42' Floor (Specify Color)	\$6,769 <sup>22</sup> EA	
I048155FR	6' x 42' Roll (Specify Color)	\$999 <sup>22</sup> EA	



### Crosslink Polyethylene Foam

- Create your own floor with our 6' x 42' x 1 1/4" cross-link polyethylene foam
- Simply have your carpet installer use this foam in place of your standard carpet underlay to create the finest permanent installation available
- Foam only - Carpet not included!

I048162		\$499 <sup>22</sup> EA	
---------	--	------------------------	--



### GSC TRAINING PITS

- Designed to absorb a great deal of impact and force
- Provide additional cushion to build confidence
- Covered in 18 oz. coated vinyl, topped with nylon mesh breather fabric and filled with soft polyfoam
- Nylon handles make these mats easy to move and store
- Available colors: **Black, Dark Green, Dark Purple, Grey, Kelly Green, Light Blue, Navy Blue, Orange, Red, Royal Blue, Tan, White and Yellow**
- Please allow 6 weeks for delivery

G795YXXX	5' x 10' x 16" Folding	\$1,649 <sup>22</sup> EA	
G796YXXX	6' x 12' x 16" Folding	\$2,189 <sup>22</sup> EA	
G798YXXX	8' x 12' x 16" Folding	\$2,799 <sup>22</sup> EA	
G816PXXX	5' x 10' x 16" Non-Folding	\$1,739 <sup>22</sup> EA	
G824PXXX	5' x 10' x 24" Non-Folding	\$2,299 <sup>22</sup> EA	
I149036	6' x 12' x 18" Non-Folding	\$2,759 <sup>22</sup> EA	
I044171	6' x 12' x 24" Non-Folding	\$3,129 <sup>22</sup> EA	



### GSC SOFLAN LANDING MATS

- Provide additional cushion to build confidence
- Covered in 18 oz. coated vinyl, topped with nylon mesh breather fabric and filled with semi-firm polyfoam
- Strategically placed nylon web handles are securely attached
- Available colors: **Black, Dark Green, Dark Purple, Grey, Kelly Green, Light Blue, Navy Blue, Orange, Red, Royal Blue, Tan, White and Yellow**
- Please allow 6 weeks for delivery

#### 8" Thick Landing Mats

G785YXXX	5' x 10' Folding	\$959 <sup>22</sup> EA	
G786YXXX	6' x 12' Folding	\$1,459 <sup>22</sup> EA	
G788YXXX	8' x 12' Folding	\$1,799 <sup>22</sup> EA	
G904YXXX	4' x 8' Non-Folding	\$559 <sup>22</sup> EA	
G905YXXX	5' x 10' Non-Folding	\$829 <sup>22</sup> EA	
G906YXXX	6' x 12' Non-Folding	\$1,349 <sup>22</sup> EA	

#### 12" Thick Landing Mats

G935YXXX	5' x 10' Folding	\$1,459 <sup>22</sup> EA	
G936YXXX	6' x 12' Folding	\$1,859 <sup>22</sup> EA	



### TRAPEZOID FOAM VAULTING BOX

- Hook and loop fasteners securely hold the 4 sections together
- Use as a vaulting horse or spotting platform
- Provides the firm footing and stability required for developing jumping, motor skills and beginning gymnastic routines

1041637 48"H x 48"W x 36"L \$1,299<sup>99</sup> EA ★ **SAH**

Compare to vaulting boxes with only three sections! Great for developing motor skills!



### DOWNHILL MATS

- Multi-use mats are ideal for teaching beginning gymnasts basic rolls and walkovers
- Polyurethane foam covered with 18 oz. reinforced, coated vinyl
- Multi-colors only

1041712	Folding 16"H x 48"W x 72"L	\$399 <sup>99</sup> EA ★ <b>SAH</b>
1041705	Folding 22"H x 60"W x 120"L	\$999 <sup>99</sup> EA ★ <b>SAH</b>
1041743	Non-Folding 15"H x 24"W x 36"L	\$179 <sup>99</sup> EA ★
1041651	Non-Folding 16"H x 36"W x 72"L	\$349 <sup>99</sup> EA ★ <b>SAH</b>
1041668	Non-Folding 16"H x 48"W x 72"L	\$369 <sup>99</sup> EA ★ <b>SAH</b>



### AAI STRATUM VAULTING BOARD

- Adjustable 8 coil premium board
- FIG Approved
- Meets USAG, NCAA, NFHS and AAU competition specifications
- Front of the board is held at the desired tension and shape with nylon webbing strap, which prevents shifting
- Number of springs can be adjusted to meet the needs of the gymnast's weight and ability
- Constructed of gray carpet with 1/2" padding
- Black oxide springs provide desired rebound

1052138 8 5/8"H x 23 5/8"W x 47 1/4"L (22 x 60 x 120cm) \$1,059<sup>99</sup> EA **SAH**

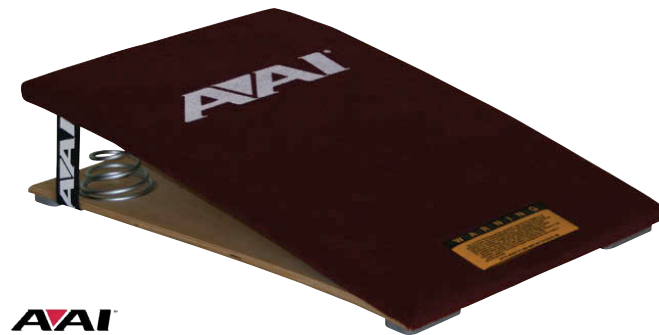

### AAI JUNIOR SPRING BOARD

- Constructed of 1/2" 8-ply cross-grain maple and poplar plywood and padded with 1/4" polyethylene foam with a carpeted surface
- Three zinc-plated wire springs are placed across the front of the bottom board
- AAI logo is placed to assist user in focusing on the board
- For children under 85 lbs.

1306293 8"H x 21"W x 33"L \$419<sup>99</sup> EA **SAH**



### AAI CONTOURED VAULT SAFETY ZONE

- The contoured shape hugs the Stratum Vault Board to help keep gymnasts safe during round-off entries
- Meets USAG, NCAA, NFHS and AAU competition specifications
- Constructed of three internal layers of foam and reinforcement materials which adds strength and durability while covered with an anti-bacterial and anti-fungal vinyl
- Front portion of the zone slopes downward at a height of 8 3/4" (210mm) to 3-9/16" (91mm) along the 40" length of the cut-out
- Shorter sides allow air to escape and the rear edges of the zone are contoured to fit within the legs of the vault base
- 4' x 4'8" - Cut out 24-3 3/4" x 40"

1332087 Non-Folding \$809<sup>99</sup> EA **SAH**

**BSN SPORTS**

### GYM CHALK

- For weight-lifting or gymnastics
- Conveniently wrapped in 2 oz. blocks
- Eight blocks per 1 lb. package

PGE4360X \$15<sup>99</sup> LB ★





EVERLAST

### PROTEX 2 VINYL GLOVES

- Constructed from durable and long-lasting synthetic leather
- Features a superior dual support panel for superior wrist protection and comfort
- Curved anatomical grip and fit

1281842 Black-14 oz \$48<sup>22</sup> PR  
1281859 Black-16 oz \$48<sup>22</sup> PR



EVERLAST

### PRO STYLE GLOVES

- Constructed from durable and long-lasting synthetic leather
- Curved anatomical grip and fit
- Hook-and-loop strap for ease of use

1281828 Black-14 oz \$34<sup>22</sup> PR  
1281835 Black-16 oz \$34<sup>22</sup> PR



EVERLAST

### EVERGEL HAND WRAPS

- Evergel handwraps that provide 3 layers of gel over the knuckles to absorb the impact.
- Hook and loop wrist wrap support strap
- Color: Black
- Size: **MED, LRG, XLG.**

1263275 \$24<sup>22</sup> PR



EVERLAST

### NEOPRENE BAG GLOVES

- Made of comfortable and tough neoprene material
- Weighs less than 4oz
- Elastic wrist cover
- Allows both speed and power when working out.
- One Size Fits All

1310214 \$22<sup>22</sup> PR



EVERLAST

### MANTIS MITTS

- Constructed of 100% vinyl and three layers of foam
- Curved design for ability to absorb punches
- Smaller surface helps develop speed and timing

1051216 \$49<sup>22</sup> PR



EVERLAST

### PRO BAG GLOVES

- Premium grade leather glove
- Styled from top professional bag gloves
- Padded palm
- One size fits all

1369526 \$39<sup>22</sup> PR



EVERLAST

### DURAHIDE™ HEADGEAR

- Made of synthetic leather
- Offers excellent visibility
- Velcro® closures for top and back of head
- Adjustable chin strap

1051209 \$39<sup>22</sup> EA

EVERLAST

### DOUBLE END STRIKING BAG

- Made of high quality synthetic leather
- Double ended ball design for focused strikes
- Includes floor and ceiling fixture, shock cord and nylon rope

1281897 \$31<sup>22</sup> EA



EVERLAST

### CARDIO FITNESS TRAINING BAG

- Easy assembly with new and improved durable foam construction for strikes
- Heavy duty spring neck for quick and responsive rebound
- Base approx. 32 lbs when filled with water
- Bag height: 5' 4"

1387105 \$99<sup>22</sup> EA



EVERLAST

### HYPERFLEX STRIKE BAG

- Punch-bag design allows for easy movement around target, increasing cardio, leg conditioning and hand-eye coordination.
- Dual hyperflex individual locking springs provide 3 workout settings for comprehensive punching, reflex, and cardio workouts
- High density plastic base, approx 70 lbs when filled with water.
- 63" tall at highest setting

1387104 \$109<sup>22</sup> EA





### WAVEMASTER® XXL

- Bag-18" dia. x 52"H, Base-28" dia x 69" total Height
  - The ultimate bag with the largest kicking and punching surface
  - Low-profile base provides stability and functionality
  - Extra-large fill hole and cap
- Color Options: **Black, Blue, Red.**

20028463

\$349<sup>99</sup> EA

### WAVEMASTER™

- Freestanding bag, round base for easy roll relocation
  - Ideal for martial arts workouts or kickboxing
  - Train and develop core muscles while enhancing coordination, endurance, and flexibility
  - 8 Height adjustments for 47" to 68"
  - Weighs approx. 270lbs when filled
- Color Options: **Black, Blue, Red.**

5624XXXX

\$184<sup>99</sup> EA

### POWER CORE BAG

- PowerCore steel plate technology improve overall strength
- PTR (Power Transfer Ring) collar offers superior impact absorption and recoil
- Compact base allows for increased accessibility
- Open base design allows for easy addition of sand or water

1281996

\$176<sup>99</sup> EA

### CENTURY BOB XL

- Larger full size mannequin than the original "BOB"
- Ideal for martial arts and kickboxing
- Round base for easy relocation
- Adjust from 60"-82"

1369487

\$399<sup>99</sup> EA

S&amp;H



### CENTURY BOB "BODY OPPONENT BAG"

- Full size mannequin with two heights 5'6" or 6' tall
- Made from high strength plastisol for durability
- Inner cavity filled with durable urethane foam
- Fill base with sand or water

20028143

\$359<sup>99</sup> EA

S&amp;H



### 6-PIECE SPEED BAG SET

- 24" smooth finished adjustable wooden drum
- Powder coated enamel brackets
- Comes with hand wraps, bag gloves, leather speed bag with swivel and jump rope.

1051223

\$99<sup>99</sup> SET

### SPEED BAG PLATFORM

- Full 15-inch thick strike board with 24-inch diameter that handles all speed bag sizes
- Easily adjust platform to ideal height for any athlete using convenient spring pin lock
- Complete with swivel, two brace boards, assembly hardware and full end padding for safety
- Bag and wall mounting hardware not included

1282016

\$139<sup>99</sup> EA

### DURAHIDE SPEED BAG

- Durahide leather design
- Reinforced seaming for long-lasting durability
- Quick, lightweight rubber bladder insert
- Balanced for accurate rebounds

1281873

Size: 9" x 6" \$28<sup>99</sup> EA

### LEATHER SPEED BAG

- Top Grade Leather
- Reinforced seaming for long lasting durability
- Balanced for accurate rebounds

1281880

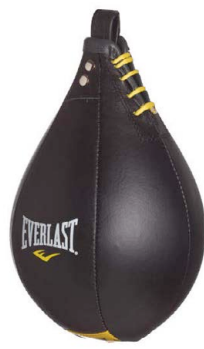
Size: 10" x 7" \$37<sup>99</sup> EA

NEW!



### BRAVE™ SPEED BAG

- Speed bag enhances reflexes and sharpens hand-eye coordination
- Engineered balance for consistent recoiling
- Lacce-up neck and stitched seams constructed for durability

1390052

10" x 7" \$24<sup>99</sup> EA

### SPEED BAG SWIVEL

- New cotter pin makes changing bags easy
- Triple chrome plated heavy duty steel for extra long durability
- Lightning fast for pro use
- Sealed inner ball-bearing make for super quiet and efficient action

1281910

\$26<sup>99</sup> EA



### 70 LB POLY CANVAS BAG

- Specially blended filler mix of sanitized synthetic and natural fibers provides resilient shock absorbency
- Premium polycanvas with reinforced webbing along with excellent construction provides durability and functionality
- Heavy duty straps provide security and safety

1387103 \$89<sup>22</sup> EA



### NEVATEAR TRAINING BAG

- Made of durable long lasting synthetic leather
- Specially blended filler provides resilient shock absorption
- Complete with heavy-duty chain and swivel

1281965 80 lb \$87<sup>22</sup> EA  
1281972 100 lb \$122<sup>22</sup> EA



### 100 LB HEAVY BAG

- Impact-resistant polyurethane cap
- 30% larger than UFC traditional training bag
- Constructed of a vinyl embossed shell
- Weights approx 100 lbs. when filled
- Designed to withstand MMA workouts

1369488 \$149<sup>22</sup> EA

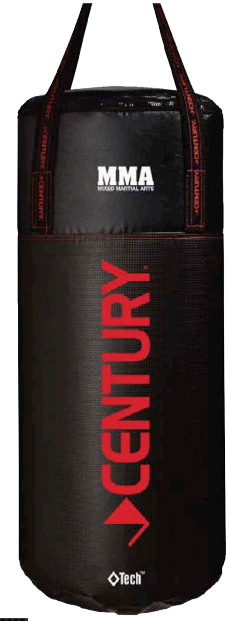

### MMA HEAVY BAG

- Ideal heavy bag for all fitness levels
- Composed of the high tensile strength DiamondTech™ fabric made specifically for combat sports
- Durable web straps for hanging
- Filled with shredded cotton and poly fibers as well as sand for weight

1369493 70 lb \$76<sup>22</sup> EA   
1369494 100 lb \$94<sup>22</sup> EA



### C3 FOAM HEAVY BAG

- Contoured Closed-Cell(C3) Foam Technology provides increased cushioning and force dispersion
- Polycanvas sleeve increases durability
- Ultra durable Nevatear shell, filling stuffed with natural and synthetic fibers blended with sifted sand
- Double-end attachment

1281934 70 lbs. \$159<sup>22</sup> EA



### HEAVY BAG/SPEED BAG STAND

- 3" tubular steel construction with weight pegs on each leg
- 24" wooden platform and steel swivel
- Handle on adjustable speed bag platform for 8 easy adjustments and 2 locking pins for stability
- 85" high, heavy bag tie down at base
- Stand can hold a heavy bag up to 100 lbs
- **Heavy bag and speed bag not included (please see Century heavy bags and speed bags)**

1158304 \$199<sup>22</sup> EA



### HEAVY BAG STAND

- 3" tubular steel construction with 3 weight pegs for stability
- Stand can hold up a heavy bag up to 100 lbs
- **Heavy bags and weights not included (please see Century heavy bags)**

1378133 \$139<sup>22</sup> EA

## FOX 40 WHISTLES/LANYARDS



### CLASSIC

- Revolutionary design allows for 3 aerodynamic wind chambers to deliver a sharp, clear tone with less effort
- No cork ball to stick or deteriorate
- Unaffected by moisture
- Extremely loud, recommended for official use only

**MSWHIFOX** Fox 40 Classic \$6.22 EA  
**I240368** With Mouth Grip \$7.22 EA



### ECLIPSE

- The Fox 40® Classic™ Eclipse™ has the authentic Classic sound in a sleek design and integrated co-molded Cushioned Mouth Grip (CMG®)
- No moving parts to freeze, jam or deteriorate
- Chambers are designed to self-clear when submerged in water
- Assortment includes: 2 black, 2 red, 2 orange, 2 yellow, 1 pink, 1 blue, 1 green, and 1 white

**I364614** Assorted Colors with Lanyard \$69.22 DZN  
**I296815** Black Whistle Only \$6.22 EA



### BREAKAWAY LANYARD

- Fox 40 Lanyards are 3/16" rope-style woven with the Fox 40 logo
- Includes J-hook and button style spring loaded adjustable cord lock
- 36" in length

**I383898** Black only \$13.22 DZN



### ACME TORNADO 2000

- Unique design specially developed to be heard over intense crowd noise and greater distances
- Black

**I376525** \$49.22 DZN



### ACME THUNDERER 60 1/2

- Famous English whistle
- Nickel-plated, tapered mouthpiece, natural cork ball

**I376531** \$79.22 DZN



### ACME THUNDERER 660

- Fitted with natural cork ball, split ring

**I376526** \$29.22 DZN



### MacGregor

#### HEAVY-DUTY NICKEL PLATED WHISTLE

**I376527** \$39.22 DZN ★



### MacGregor

#### RUBBER WHISTLE COVER

- Protects lips, teeth and whistle
- Whistle not included

**I376529** \$7.22 DZN ★



### MacGregor

#### ECONOMY BLACK PLASTIC

- Natural cork ball and split ring

**I376530** \$9.22 DZN ★



### LANYARDS

- 100% nylon lanyard with clamp and swivel
- Must order 12 per color
- Whistles not included

Color Options: **Gold, Kelly, Royal, Scarlet, White, Black, Maroon.**

**MSLNYD** \$9.22 DZN ★



### WINDSOR ELECTRONIC WHISTLE

- Loud consistent sound every time
- Easier to give verbal commands without a whistle in the user's mouth
- Each set of AAA batteries produce more than 1000 blasts
- Loud 105db whistle sound can be aimed in the exact direction intended
- Improve hygiene - hand operated instead of mouth blown is sanitary for multiple users
- Comes in single tone or 3 selectable tones (pealess whistle, buzzer or alarm tone)

**I. I309980** 3-Tone \$19.22 EA  
**2. I306989** Single Tone \$18.22 EA



### LAUNDRY BAGS

- White nylon mesh bag with drawstring

**MSLB1824** 18" x 24" \$7.22 EA ★  
**MSLB2436** 24" x 36" \$9.22 EA ★



### DELUXE LAUNDRY BAG

- Heavy duty 100% polyester mesh
- Cotton ID flag for player name or number marking
- Rubber closure attached
- Color Options: **Black, Gold, Royal, Scarlet, White.**

**I197327** Laundry Bag - 18" x 24" \$8.22 EA ★  
**I240214** Red Rubber Closure \$2.22 EA ★



### SINGLE LATCH LAUNDRY BELTS

- Washes cleaner and dries more completely than bag method
- Eliminates danger of burning hands when using pin method
- Reduces noise during washing and drying
- White tag to write players # on belt
- Sold in case of 25

Color Options: **Black, Cardinal, Columbia Blue, Dark Green, Grey, Kelly, Maroon, Orange, Purple, Royal, Scarlet, Silver, Vegas Gold, White.**



**I383899**

Specify Color

\$59.22 CASE

**EKHO STOP WATCHES**



**NEW!**

**K-350 STOPWATCH**

- 100 Lap and split memory with 1/100 second precision
- Individual lap time, total time, fastest lap, average lap time calculation
- Two individual daily alarm
- Two row time, date, and day display

**5 Year Limited Warranty**

**I376386**

\$25<sup>22</sup> EA ★



**NEW!**

**K-250 STOPWATCH**

- 30 laps and split memory with 1/100 second precision
- 2 line display
- Fastest lap and slowest lap calculation
- Countdown timer

**5 Year Limited Warranty**

**I376385**

\$18<sup>22</sup> EA ★



**NEW!**

**K-150 STOPWATCH**

- 1/100 second precision with lap counter(for the first 30 minutes)
- Calendar and Time display(12/24 hr format)
- Daily alarm
- Hourly chime

**5 Year Limited Warranty**

**I376384**

\$16<sup>22</sup> EA ★



**TABLE TOP INFLATOR**

- Lever action pump
- Heavy-duty steel cylinder, handle and clamp

**MSTTPBSNY**

\$29<sup>22</sup> EA ★



**HD INFLATOR**

- 1/6 horsepower AC motor
- 80psi with pressure gauge
- Includes needle and tire valve
- Weight: 8 lbs.

**I240672**

\$184<sup>22</sup> EA ★



**STEEL HAND INFLATOR**

- Compact, lightweight and portable
- Made of heavy duty steel to last through the years
- Needle included

**MSHNINF5Y**

\$5<sup>22</sup> EA ★



**HEAVY DUTY UPRIGHT PUMP**

- 21" reinforced hose
- In-line gauge provides correct pressure for all types of balls
- Needles sold separately

**I069273**

\$19<sup>22</sup> EA ★

**ECONOMY ELECTRIC INFLATOR**

- High impact plastic desktop inflator
- 120v and .9 amps
- 100 psi gauge
- Coiled inflation tube that will stretch to 30"
- Comes with needle and other inflation valves

**MSECOELEY**

\$99<sup>22</sup> EA ★



**BEST SELLER**

**MINI ELECTRIC INFLATOR**

- Lightweight and super quiet electric inflator
- 120v and 2.5 amps
- 150 psi gauge
- Inflation tube is 48" long
- Comes with inflation needle and other valves

**I187793**

\$129<sup>22</sup> EA ★



**ACCESSORIES**

**MSNEDPAC6**

Needle Pack

\$2<sup>22</sup> PACK OF 6 ★

**MSNED100**

Pack of 100 Needles

\$24<sup>22</sup> PACK OF 100 ★

**I369558**

Digital Pressure Gauge

\$24<sup>22</sup> EA ★



**DOUBLE ACTION HAND PUMP**

- Compact, lightweight and portable
- Pump twice the volume of air with dual action
- Needle included

**I369557**

\$9<sup>22</sup> EA ★



**AIRMAN® CORDLESS**

- Simple one handed, push button operation
- Will inflate anything from balls to bicycle tires
- 9.6v rechargeable nicad battery
- 120 psi gauge
- Includes AC power cord and charger and 12v DC cord

**I22006XXX**

\$74<sup>22</sup> EA



**MV-10S MEGAPHONE**

- 600 yard range - 16 watts of power
- Used by U.S. Army, Navy, Air Force and Marines
- For indoor/outdoor use
- Variable volume control
- Solid-state, built-in microphone
- Foghorn signal
- Operates on (6) C batteries (not included)

MV10S

\$164<sup>22</sup> EA**MV-20S MEGAPHONE**

- 1000 yard range - 25 watts of power
- Microphone hooks to end or detached with shoulder strap
- Solid state amplifier has signal alarm for warning alert
- Dynamic microphone with coiled cord and talk switch
- Pistol-trigger switch
- Operates on (8) C batteries (not included)

1271331

\$224<sup>22</sup> EA**MV-16S MEGAPHONE**

- 800 yard range - 20 watts of power
- Signal alarm switch
- Pistol-trigger talk switch
- Dynamic microphone
- Carrying strap
- Weatherproof construction
- Operates on (8) C batteries (not included)

1271324

\$189<sup>22</sup> EA**LONG RANGE MEGAPHONES**

- 1000 yard range - 25 watts of power
- Adjustable volume control
- Siren button
- High impact PVC construction
- Operates on (8) C batteries (not included)
- Weight: 7 lbs.

MSMEG61W

Hand Held Mic

\$119<sup>22</sup> EA ★

MSMEG51W

Built-in Trigger Mic

\$82<sup>22</sup> EA ★**PORTABLE SIGNAL HORN**

- Offers a loud sound with a long lasting 8 oz. canister
- Push-button style, high-impact construction
- **CANNOT BE SHIPPED BY AIR**

MSAIR8ZH

\$29<sup>22</sup> EA

MSAIR8ZR

8 oz. Refill \$19<sup>22</sup> EA**MEGAPHONE STORAGE BAG**

- Foam padded, nylon bag
- Features a heavy-duty zipper top and carrying handle
- 14"H x 9"Dia. - for all sizes of megaphones

1274891

\$17<sup>22</sup> EA ★**MINI MEGAPHONE**

- 300 yard range - 8 watts of power
- Trigger controlled; adjustable volume control; siren button
- High impact plastic with carrying strap
- Built-in microphone
- Operates on (6) AA batteries (not included)

MSMEG22W

\$52<sup>22</sup> EA ★**Optional microphone & carrying bag****PORTABLE P.A. SYSTEM**

- 5 1/2 lb., 25 watt unit is ideal for gyms, classrooms and playground
- Can be heard up to 100 yards away
- Remote microphone can be used up to 75 yards from base unit
- Includes a lapel microphone and transmitter that attaches to a belt
- Uses standard 110v receptacle or included re-chargeable battery
- Optional hand held microphone with built-in transmitter is available for multiple speakers
- 12"H x 9"W x 5"D with molded handle

1162776

\$359<sup>22</sup> EA ★

1162783

Optional Microphone \$129<sup>22</sup> EA ★

1162790

Optional Carrying Bag \$24<sup>22</sup> EA ★**VOICE RECORDING MEGAPHONE**

- 800 yard range - 20 watts of power
- Features the ability to use as a portable message center
- Record up to a 60 second message and it will repeat hands free
- Operates on (8) C batteries (not included)

1248531

\$144<sup>22</sup> EA ★**VOICE BLASTER**

- 100 yard range - 5 watts of power
- Features a 2 1/2" speaker on an adjustable belt that fits up to a 50" waist
- Includes a re-chargeable battery adapter
- Constructed of heavy duty plastic and weighs less than 2 lbs.
- Operates on 6 AA batteries (not included)

1162769

\$69<sup>22</sup> EA ★

**NEW!**

**COMSTAR PRO SERIES HEADSETS**

- Full duplex wireless intercoms that allow coaches to talk simultaneously.
- Headsets are totally self contained and operate without belt packs
- Two coach includes one single channel Com center and two single ComStar headsets, batteries, chargers and a padded case.
- Three coach includes one single channel Com center, two single ComStar headsets, one ComStar double channel headset, batteries, chargers and a padded case

1378430 Two Coach \$1,999<sup>22</sup> EA  
 1378431 Three Coach \$2,799<sup>22</sup> EA



**NEW!**

**DUAL CHANNEL FLEX SERIES**

- Totally digital, simultaneous talk wireless headsets that can be used as offense/defense or all conference
- Simply place the dual channel com center on the sideline in the pressbox, turn on and go.
- Coaches can roam anywhere in the stadium and enjoy instantaneous voice contact
- Flex 4 comes with 1 com center, 2 single wireless headsets w/switch and 2 double wireless headsets
- Flex 5 comes with 1 com center, 2 single wireless headsets, one single wireless headset w/ switch and 2 double wireless headsets
- Flex 6 comes with 1 com center, 2 single wireless headsets, 2 single wireless headset w/switch and 2 double wireless headsets

1378425 Flex 4 \$4,599<sup>22</sup> EA  
 1378426 Flex 5 \$4,999<sup>22</sup> EA  
 1378427 Flex 6 \$5,999<sup>22</sup> EA  
 1378428 Single Headset \$799<sup>22</sup> EA  
 1378429 Double Headset \$899<sup>22</sup> EA



**COACHES RADIO PACKAGE**

- 2 Motorola® RMU2040 4-watt radios
- 2 each Eartec Ultra, heavy-duty, single earmuff headsets with built-in microphone
- Rechargeable batteries
- Belt clips and chargers
- For immediate communication between field and press box



682128 \$1,199<sup>22</sup> EA ★



**SINGLE MUFF HEADSET**

- Headset to use in noisy areas without needing to remove radio from belt
- Hear audio in quiet environment without disturbing others
- Noise cancelling boom microphone
- Covers right ear
- Works on VOX equipped radios
- For use with CLS, XTN and RDX series radios



1202038 \$229<sup>22</sup> EA

**MOTOROLA® CLS1410 2-WAY RADIO**

- UHF Business 2-way radio
- 1 Watt UHF transmit power
- 56 selectable UHF frequencies (12.5KHz channel spacing)
- Interference eliminator with 121 codes (83 digital / 38 analog)
- LCD Display with battery signal strength indicator
- "Call Alert" button with 3 tones
- Vibrate mode
- Range / Coverage up to 200,000 sq feet or 15 floors
- Includes battery, charger and belt clip holster

682131 1 Watt, 4 Channels \$299<sup>22</sup> EA  
 1239553 1 Watt, 1 Channel \$249<sup>22</sup> EA

**6 UNIT CHARGER**

- Charge up to 6 radios or batteries in 3-10 hours
- Copies or clones programming from one radio to another
- Desk or wall mountable
- Radios not included

1245691 For CLS Series \$279<sup>22</sup> EA



**FRONTROW To Go PA SYSTEM**

- A simple all-in-one system - just charge it and go
- Features DuO™ technology - multiple speakers in a single cabinet
- Capable of covering an entire gym, classroom, playground or field
- Weighs only 13 lbs. and features a dual FM receiver (allows 2 transmitters to be used at once), and a rechargeable battery (with 6 1/2 hours operating time)
- Includes auxiliary to connect to TV/VCR/DVD, computer, CD player and iPod
- Includes speaker system, head worn microphone with transmitter, charging stand, auxiliary and power cords

**5 Year Limited Warranty**

1274585 \$1,599<sup>22</sup> EA

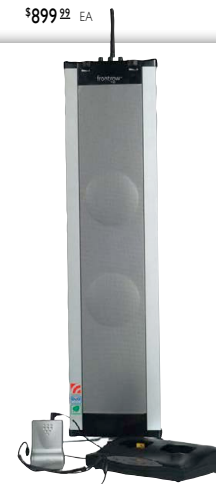

**BEHIND-THE-NECK MIC**

- Additional head-worn microphone for FrontRow To Go PA System (Item 1274585)

1274592 Requires body transmitter (1274608) \$149<sup>22</sup> EA



**BODY-WORN TRANSMITTER**

- Required to operate head-worn mic (Item 1274592)

**5 Year Limited Warranty**

1274608 \$299<sup>22</sup> EA



**WIRELESS HAND-HELD MIC**

- Hand-held microphone for FrontRow To Go PA system (Item 1274585)

1274615 \$299<sup>22</sup> EA



**CARRY BAG**

- Stores and transports the FrontRow To Go PA system (Item 1274585)

1274622 \$99<sup>22</sup> EA



**EARBUD WITH PTT MIC**

- For use with CLS, XTN and RDX radios

1239577 \$74<sup>22</sup> EA

**EARPIECE W/ CLIP-ON MIC**

- For use with CLS, XTN and RDX radios

1239560 Push to Talk \$39<sup>22</sup> EA

**RECHARGEABLE BATTERY**

- Provides up to 15 hours of service with no memory effect
- Replace every 12 months for best reliability

1202045 For CLS Series \$70<sup>22</sup> EA

COACHING



**'STEAMIN' DEMON' HOT DOG STEAMER**

- Contains stainless steel cabinet and lid (no painted parts)
- Hot dog juice tray
- Holds 80-90 hot dogs, 30-40 buns, and six quarts of water
- 1000 watts, 8.3 amps, 120 volt
- Weight: 32 lbs.

5GM8007 Size - 19"W x 16"H x 15.5"D **\$849<sup>zz</sup>** EA



**'DOGEROO' HOT DOG COOKER**

- Holds 56 hot dogs and 40 buns
- Bun warmer sits over a water pan providing moist heat to keep hot dogs in a bun and foil bag warm
- Easy to clean
- 1680 watts, 120 volts
- Weight: 60 lbs.

5GM8102 Size - 21"W x 28"H x 15"D **\$1,379<sup>zz</sup>** EA



**'MINI DOGEROO' HOT DOG COOKER**

- Small footprint is ideal for concession areas with limited space
- Holds 18 dogs
- 750 watts, 120 volts
- Weight: 47 lbs.

5GM8108 Size - 13"W x 26.5"H x 15"D **\$979<sup>zz</sup>** EA

**ECONO FLOSS COTTON CANDY MACHINE**

- Stainless steel cabinet
- Spun aluminum bowl
- "Whirl Grip" floss stabilizer
- Single 5-1/2" ribbon machine produces over 200 oz. per hour
- 1320 watts, 11 amps, 120 volts
- Size - 26-1/2"W x 26-1/2"D x 20"H.
- Weight: 37 lbs
- Optional dome not included.

5GM3017SS Cotton Candy Machine **\$1,399<sup>zz</sup>** EA  
 1033632 Optional Plastic Dome **\$349<sup>zz</sup>** EA  
 5GM3065 Cotton Candy Bags **\$89<sup>zz</sup>** CASE OF 1000  
 5GM3021 Cotton Candy Cones **\$124<sup>zz</sup>** CASE OF 4000  
 5GM320 Flossugar - 19.5 lbs (Pink or Raspberry) **\$39<sup>zz</sup>** CASE



**Emerson STAINLESS STEEL MICROWAVE**

- 1000 watts and 1.1 cubic feet of cooking space
- Black finish front with chrome handles and stainless cabinet
- 10 power levels and 8 one touch settings with speed and weight defrost
- LED display, digital clock, kitchen timer and child-safe lock
- Weight: 33 lbs.

1052466 Size - 20.5"W x 13.2"H x 17.5"D **\$229<sup>zz</sup>** EA

**SNO-KONETTE**

- Easy to operate: lift the pusher handle, fill with chunks of ice, turn on the motor and pull the handle
- 1/3 HP, 1725 RPM high-speed shaver mounted on aluminum cabinet with tempered glass windows
- Shaves up to 500 lbs. of ice per hour
- Includes: cup dispenser, sno-cone dipper, ice scoop and drain pan
- Measures 22"W x 16"D x 19"H. 816 watts 6.8 amps on 120 volts
- Weight: 67 lbs. (Will not ship UPS)

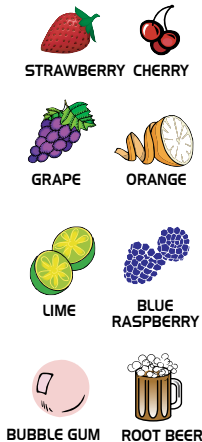

MSSK1003 Sno-Konette - Size - 22"W x 16"D x 19"H **\$1,279<sup>zz</sup>** EA  
 5GM5122 Sno-Kone Syrup - 4 Gallons **\$39<sup>zz</sup>** CASE OF 4  
 5GM1060 6 oz. Cups **\$249<sup>zz</sup>** CASE OF 5000



**HAWAII'S FINEST SHAVED ICE MACHINE**

- 1/3 HP motor and stainless steel components for trouble-free use
- Weight: 57 lbs.

1058826 Size - 15.5"W x 20"H x 21.5"D **\$2,199<sup>zz</sup>** EA





### **FRUSHEEZ™ SLUSH MACHINE**

- Popular self contained twin bowl design
- Serves two delicious frozen flavors simultaneously
- 3.7 gallon capacity per bowl
- Just add easy to use Frushee™ slush mix
- 32 7/8" H x 15" W x 15" D
- Add 3-5/8" - 4-3/4" for adjustable legs

1181302 Twin Bowl - Size - 33"H x 15"W x 15"D \$3,399<sup>22</sup> EA

### **FRUSHEEZ™ SLUSH DRINK MIX**

- Mix four parts water to one part of concentrated mix
- Specify flavor
- Flavor: **Blue Raspberry, Cherry, Lemon, Grape, Fruit Punch, Orange, Straw Daiquiri.**

1181319 1/2 Gallon \$12<sup>22</sup> EA

### **FRUSHEEZ™ PLASTIC CUPS**

- Sold by the case only
- 14 oz. plastic cups

1181388 Case of 1000 \$179<sup>22</sup> EA



### **NACHO CHIP MERCHISER**

- Stainless steel top and bottom
- Sidelight enhances chip presentation

1058857 Size - 12"W x 15.5"D x 23.5"H \$499<sup>22</sup> EA



### **DELUXE SIXTY POPPER WITH CART**

- Features antique styling, etched glass, cast filigree, brass-like antique finish and 6oz. kettle popper

1058796 Size - 18"W x 16"D x 36"H \$1,899<sup>22</sup> EA



### **DELUXE 60 POPCORN POPPER**

- 6 oz. spun aluminum kettle for fast warm up and consecutive 3 minute popping cycles
- Heavy-duty kettle drive motor, tempered glass, and strip heater corn freshener under the deck of the popper
- Measures 18"W x 16"D x 31"H.
- Weight: 56 lbs.

SGM2085 Popcorn Popper \$899<sup>22</sup> EA  
 SGM2836 6 oz. Corn Kit - 36 CT \$49<sup>22</sup> KIT OF 36  
 SGM2053 1 oz. Popcorn Bags - 1000 CT \$29<sup>22</sup> PACK OF 1000



### **EL NACHO GRANDE**

- Maintains air tight control over cheese sauce
- Eliminates messes and limits cleaning maintenance
- Has space for a second bag to pre-heat inside
- Works with all brands of bagged cheese
- Weight: 18 lbs

1058833 Size - 26"W x 10"W x 16"D \$699<sup>22</sup> EA  
 1058840 Nacho Cheese, Case of 4, 140 oz. Bags \$79<sup>22</sup> EA  
 1058802 Chili, Case of 4, 106 oz. Bags \$89<sup>22</sup> EA



**NEW!**

### **WHIZ BANG POPCORN POPPER**

- "Top of the line" 12/14oz. kettle popper
- Uni-maxx Kettle mounted in extra strong cast aluminum hanger arms
- Produces 250, one oz. servings per hour
- Removable kettle for easy cleaning
- Weight: 105 lbs.
- Voltage: 120; amps: 20; wattage: 2400

1277104 Size - 28"W x 20.5"L x 40"H \$1,799<sup>22</sup> EA

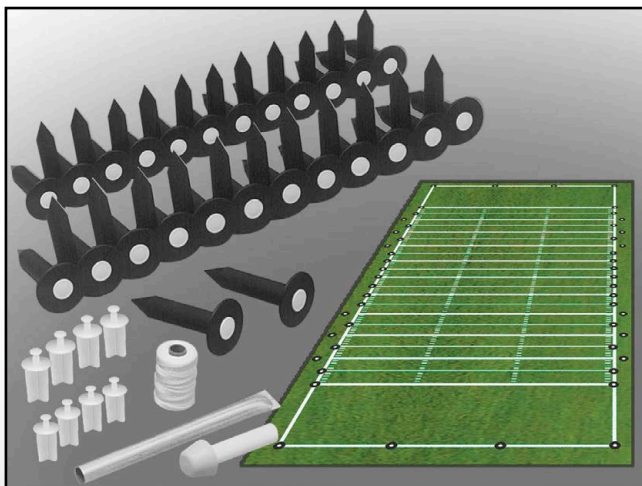
**Football Field Lining Set**

- Set includes 50 sockets with plugs
- Installation accessory kit
- Marks complete football field - 5 yard increments, goals and hash marks

MKFLP50

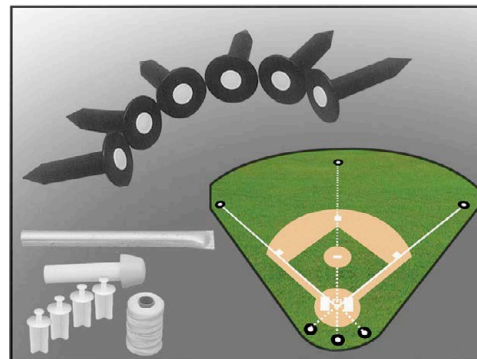
\$429<sup>22</sup> EA**Baseball Field Lining Kit**

- The essential kit to properly line all baseball or softball fields
- Provides 6 ground sockets to establish perimeter and midfield locations and hold game day markers
- Kit includes: 6 sockets with plugs, 4 lining pegs, pilot hole tube and socket setter

MKBLP6

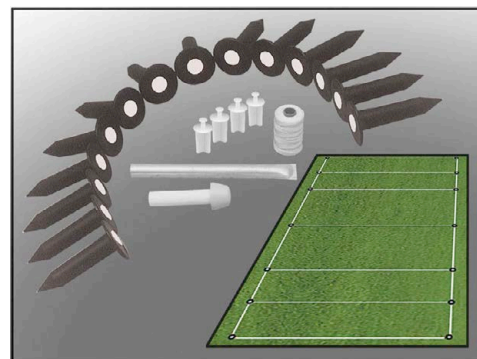
\$99<sup>22</sup> EA**Intramural Lining Package**

- Most intramural and club sports require 14 line intersection reference points of the field
- Everything you need to establish permanent reference locations for flag football, lacrosse, field hockey, rugby and others
- Set includes: 14 sockets w/plugs and installation accessory kit

MKILP14

\$154<sup>22</sup> EA

**"ANYTIME IS THE RIGHT TIME  
TO PERMANENTLY MARK  
FIELDS...BEFORE, DURING, OR  
AFTER THE SEASON!"**

**DO IT ALL WITH ONE SET**

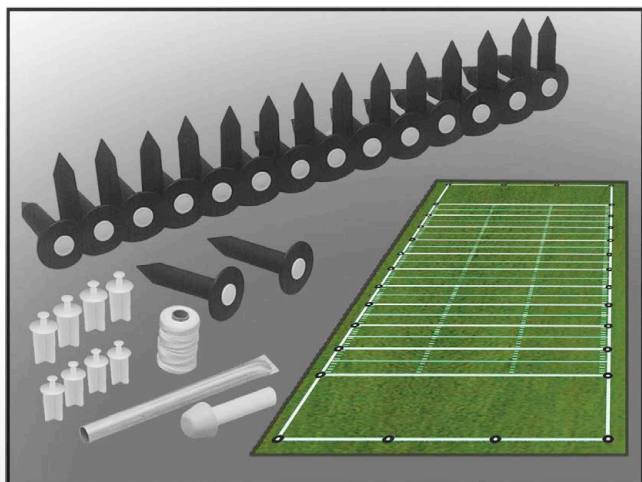
**Football Practice or Band Lining Set**

- Set boundary lines, goal lines, every ten yard lines and hash marks
- Great for band practice fields as well
- Set includes 30 sockets with plugs
- Installation accessory kit

MKPFLP30

\$299<sup>22</sup> EA**FIELD MARKING ACCESSORIES****GROUND SOCKET CAPS**

- 12 pack of plugs for MarkSmart ground sockets
- Use color coded cap for multiple field configurations

Color Options: **Orange, White, Yellow.**

MKAI03Y

Specify Color \$13<sup>22</sup> DZN**GROUND SOCKET WITH CAP**

- Individual 8" ground socket with plug

MKAI01

Ground Socket with Plug \$8<sup>22</sup> EA**HEAVY DUTY POLYESTER TWINE IN  
500 FOOT ROLL**

- Heavy duty twisted polyester rope.

MKAI02

\$13<sup>22</sup> EA**GROUND SOCKET LINING PEGS - 10/SET**

- 10 pack of lining pegs for MarkSmart lining system
- Insert in ground sockets to attach twine

MKAI04

\$14<sup>22</sup> SET**GROUND SOCKET AUGER**

- Use to set your ground sockets in place
- Attaches to any standard drill; size: 3/8" shaft, 1 1/4" diameter, 12" length

MKGSA12

\$29<sup>22</sup> EA**GROUND SOCKET PUNCH-  
PILOT HOLE TOOL**

- Easy to use pilot hole tool for ground socket installation
- Helps to remove soil/dirt and create a crevice for ground socket insertion

MKAI05

\$12<sup>22</sup> EA**PAIR OF GROUND  
SOCKET SETTERS**

- Designed to be placed in the ground socket so you can hit these instead of the ground socket directly

MKAI06

\$3<sup>22</sup> PR**TWINE OR CORD REEL -  
NO TWINE INCLUDED**

MKTCR10

\$19<sup>22</sup> EA**TWINE REEL WITH 500  
FEET OF HEAVY DUTY  
POLYESTER ROPE**

Includes 500 feet of heavy duty polyester twine

MKTCR638

\$29<sup>22</sup> EA

## COMBINATION VALUE PACKS FOR A COMPLETE SOCCER FIELD

**MARKERS, INC.**  
Quality Products at Reasonable Prices

### SPRING LOADED SOCCER CORNER FLAGS

- Spring loaded corner flags that "give" when contacted by a player and return upright automatically
- 2-Piece 1.33" O.D. PVC poles
- High visibility orange flags
- Includes: 4 flags with ground sockets with plugs, installation accessory kit and storage bag.

**MK4X4S** 60"H \$169<sup>92</sup> SET

- Includes: 6 flags with ground sockets with plugs, installation accessory kit and storage bag.

**MK6X6S** 60"H \$229<sup>92</sup> SET

- Includes: 6 flags and storage bag. Ground sockets not included.

**MK6FB** 60"H \$169<sup>92</sup> SET

**MKA101** Ground Socket with Plug \$8<sup>92</sup> EA

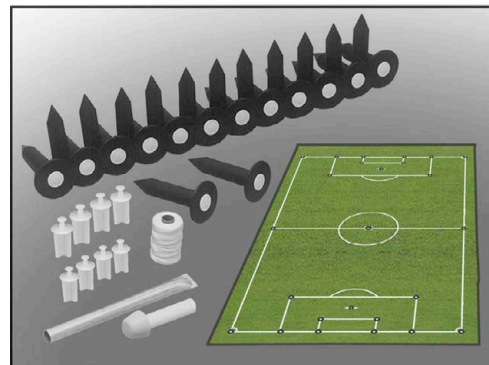

### SOCCER FIELD LINING KIT

- Set includes: 25 sockets with plugs, 8 line pegs, installation accessory kit (IAK).
- All the necessary tools and products to establish permanent reference points for a regulation soccer field

**MKSLP25** \$239<sup>92</sup> EA

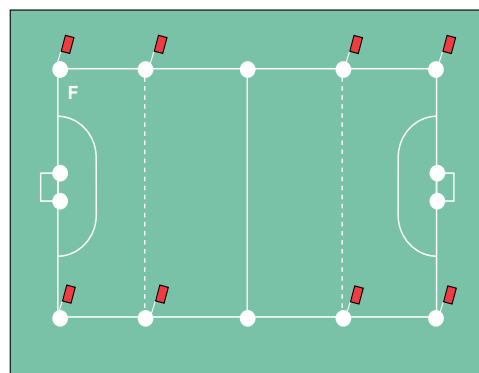

### FIELD HOCKEY MARKING SET

- 14 ground sockets with plugs
- 6 Tufflag game day flags
- Installation accessory kit
- Storage bag

**MKFHI46** \$269<sup>92</sup> SET

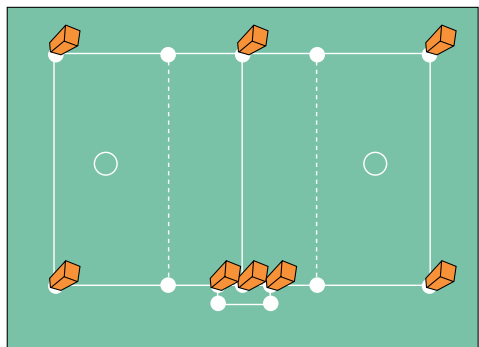

### LACROSSE MARKING SET

- 14 ground sockets with plugs
- 8 pylons
- Installation accessory kit

**I162417** \$299<sup>92</sup> SET



**MARK YOUR SOCCER FIELD WITHOUT THE HASSLE!**

**MARKERS, INC.**  
Quality Products at Reasonable Prices

### REFLEX SOCCER CORNER FLAGS

- Reflex corner flag
- 1-Piece 1.33" O.D. PVC poles
- High visibility orange flags
- Includes: 4 flags with ground sockets & plugs and installation accessory kit. Storage bag not included

**MK4RFGSP** 66"H \$145<sup>92</sup> SET

- Includes: 6 flags with ground sockets & plugs and installation accessory kit. Storage bag not included.

**MK6RFGSP** 66"H \$189<sup>92</sup> SET

- Includes: 4 flags and storage bag. Ground sockets not included.

**MK4FB** 66"H \$129<sup>92</sup> SET

**MKA101** Ground Socket with Plug \$8<sup>92</sup> EA



**TRUELINE®  
AIRLESS SPRAY  
STRIPER**

- Stainless steel paint tank
- Four 10" pneumatic tires
- 120 psi
- 10 lb. CO2 cylinder holds enough pressure to stripe 20 football fields before refilling (paint not included)
- 4" spray box
- Choose between 7 or 12 gallon paint tanks



1237030 7 Gallon Capacity  
1237047 12 Gallon Capacity

\$1,699<sup>92</sup> EA   
\$1,899<sup>92</sup> EA

NEW STRIPE

**SCOTSMAN FIELD  
MARKER**

- Our most economical field striper
- Loop handle with foam grip for better control
- Four 8" x 1.5" high impact rubber wheels
- Operates at 30-35 psi with hand pump pressure gauge
- Instantaneous shut off - no dripping
- Adjustable 2"-6" line width
- Handle mounted controls
- Optional CO2 power pack available
- 4 gallon capacity
- 3 Year Limited Warranty**



MSSCOTSX  
MSSCOTPP

W/O CO2 Tank  
Optional CO2 Power Pack

\$699<sup>92</sup> EA  
\$999<sup>92</sup> EA

NEW STRIPE

**EcoLINER™ BATTERY POWERED  
FIELD STRIPING MACHINE**

- Features a heavy duty, diaphragm pump powered by a 12-volt deep cycle battery, never flat tires and all steel construction
- Quickly paint professional quality lines for hours on a single battery charge
- Simply, place a 5-gallon pail of premixed paint on the machine and you are ready to mark your field
- No pressurized tanks. No need to release pressure to add paint or clean. No high-pressure pump output to prohibit operator injury
- Line width is fully adjustable from 2"-6", allowing for greater flexibility to meet your field marking needs
- Equipped with a quick charge 120V plug in battery charger to provide the fastest charging time available.
- 3 Year Limited Warranty**



5NSECLNR 5 Gallon Capacity

\$1,999<sup>92</sup> EA

**FIELDLAZER™  
STRIPER**

- Exclusive tall-wheel cart rolls easily over ruts and cleat marks
- Easy out filter makes tip clogs a thing of the past
- 35cc Honda 4 stroke engine
- Three semi pneumatic 14" tires
- 900 psi
- Gas tank holds .65 gallons and should be good for 45 minutes
- Adjustable spray shields make line width changes from 4"-8" fast and easy with no tools
- Siphons from the original 5 gallon paint container to eliminate tank and pot cleaning hassles
- Fold-down handle makes transportation easy; Weight: 80 lbs.



1179477  
1236286

5 Gallon Capacity  
30" Tip Extension

\$3,599<sup>92</sup> EA   
\$79<sup>92</sup> EA

**FIELD STRIPE MODEL D**

- Powered by a Honda 4 HP engine
- Floating gun assures consistent line width on even the most uneven turf surfaces
- Electronic pressure controls for use with turf or pavement striping paints; Pressure can be adjusted from 0 to 3000 psi
- Features an airless head assembly that snaps onto a multi-position spray arm delivering consistent line width
- Patented REV-TIP reversible spray tip clears clogs effortlessly
- Paint is pumped directly from any standard 5 gallon paint bucket
- Includes hand spray gun for stencils, buildings, walls, etc.



1237078 5 Gallon Capacity

\$3,999<sup>92</sup> EA

**AIRLESSCO FIELD STRIPE PLUS (+)**

- RADIUS MEMORY delivers smooth consistent curves and circles
- 160cc Honda 5.5 hp engine
- 3000 psi
- Gas tank holds 1 gallon

1237085 5 Gallon Capacity

\$4,499<sup>92</sup> EA

## DRY LINE MARKERS



### 4-WHEEL LINE MARKERS w/ PNEUMATIC TIRES

- The most durable line marker on the market
- 11 gauge steel frame
- 18 gauge galvanized steel bucket
- Tires measure 3.5"W x 10"D
- Easily adjustable to either 2" or 4" lines

<b>1. BBHDDM10</b>	100 lb. Capacity	\$354 <sup>22</sup> EA ★
<b>2. BBHDDM50</b>	50 lb. Capacity	\$324 <sup>22</sup> EA ★

### 4-WHEEL DRY LINE MARKERS

- All steel construction
- 4 hard rubber wheels for extra durability
- Easily adjustable to either 2" or 4" lines

**3. BBDLM654** 4-Wheel 65 lb. Capacity \$239<sup>22</sup> EA ★

### 2-WHEEL DRY LINE MARKER

- All steel construction
- 2 hard rubber wheels for extra durability
- Easily adjustable to either 2" or 4" lines

**4. BBDLM252** 2-Wheel 25lb. Capacity \$169<sup>22</sup> EA ★

### FIELD MARKING PAINT

- Concentrate paint eliminates the need to measure
- Helps to save storage space
- Produces bright long lasting lines



1379971	1 Gallon Pail - White	\$54 <sup>22</sup> EA
1379972	5 Gallon Pail-Specify Color	\$164 <sup>22</sup> EA



### FOOTBALL FIELD STENCIL KIT

- Kit contains 0-5, G and directional arrow
- Cut from 1/8" plastic - ultimate durability
- Keeps your field clearly and attractively marked

1385374 \$834<sup>22</sup> SET

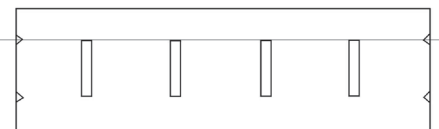

### FOOTBALL HASH MARK GUIDE

- Made from tough Coroplast material
- Easy to use - will fit between yard lines
- Paint through template
- V notches for string alignment
- Includes storage tube

1162653 \$269<sup>22</sup> EA



### STRIPING WAND

- Use for convenient touch-up of lines or stenciling
- Sturdy, lightweight construction
- Works with Markl field striping paint

1237092 \$64<sup>22</sup> EA

### ATHLETIC FIELD STRIPER

- For use on grass, dirt, concrete, pavement or gravel
- Sturdy steel construction with 4 large, easy rolling wheels and a collapsible handle for easy storage
- Lightweight housing includes windscreen, fingertip on/off lever, storage for 12 extra cans and simple 2" - 4" line width adjustment
- Non-toxic aerosol spray goes straight downward for complete coverage (paint sold separately)
- Maintenance free, no messy clean up



0795XXXX \$134<sup>22</sup> EA



### FIELD STRIPING PAINT

- Our 3 main colors, White, Orange and Yellow will give you up to 700 feet of spray based on a 4" line
- Compare that with others that offer only 300-400 feet based on a 4" line. That's like getting 2 cans for the price of one
- Will not flake or wash away
- Cans are 17 oz. by weight

#### Case Price (12 Cans)

0792XXXX	White	\$59 <sup>22</sup>	CASE OF 12 CANS
0792ORXX	Orange	\$59 <sup>22</sup>	CASE OF 12 CANS
0792YLXX	Yellow	\$59 <sup>22</sup>	CASE OF 12 CANS
0792CXXX	Other colors - Standard Nozzle	\$79 <sup>22</sup>	CASE OF 12 CANS

#### 3 Case Master (36 Cans) Save!!

0792PACK	White	\$154 <sup>22</sup>	PACK OF 36 CANS
0792CPACOR	Orange	\$159 <sup>22</sup>	PACK OF 36 CANS
0792CPACYL	Yellow	\$159 <sup>22</sup>	PACK OF 36 CANS
0792CPAC	Other colors - Standard Nozzle	\$189 <sup>22</sup>	PACK OF 36 CANS

Green

Purple

Maroon

Navy

Black

Royal

Red

Orange

Yellow



White

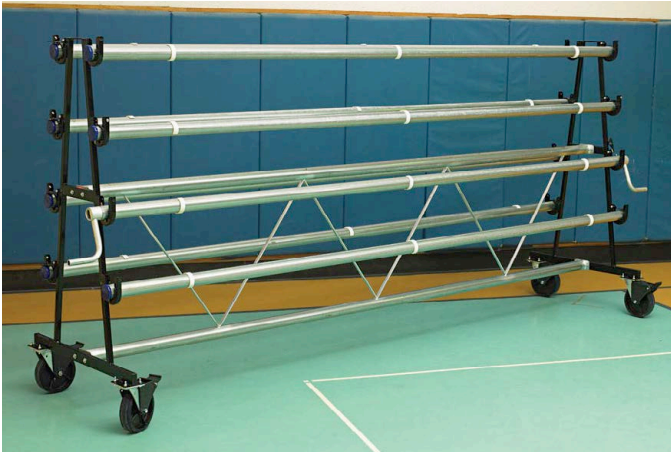

### GYM FLOOR COVER MOBILE STORAGE RACKS

- Use with 10' wide sections only
- All steel rack with Delrin roller bearings
- Supports up to 2800 lbs.
- Four 8" diameter non-marring wheels for easy rolling (2 with locks)
- Includes 2 hand cranks for winding, 3 fabric clips per roller, and instructions
- 2 1/2" diam., 14 gauge steel rollers with locks to prevent accidental unwinding
- 67"H x 34"W x 12'6"L

**6 Year Limited Warranty**

1048407	6 Roller Model	\$3,129 <sup>22</sup> EA	
1048414	8 Roller Model	\$3,649 <sup>22</sup> EA	
1048421	10 Roller Model	\$3,854 <sup>22</sup> EA	



### GYM FLOOR COVER PREMIER STORAGE RACKS

- Same design as our standard Mobile Storage Racks with added features
- 6 casters instead of 4 to spread the floor load
- Leg extenders for increased stability
- Storage bins on the ends to store accessories
- 67"H x 34"W x 12'6"L

**6 Year Limited Warranty**

1279856	6 Roller Model	\$3,849 <sup>22</sup> EA	
1279863	8 Roller Model	\$4,119 <sup>22</sup> EA	
1279870	10 Roller Model	\$4,269 <sup>22</sup> EA	



### ELECTRIC POWER WINDER

- Quickly and easily winds up each gym floor cover section

1048438	\$1,249 <sup>22</sup> EA	
---------	--------------------------	--



### RACK BRUSH ASSEMBLY

- Bolts to the rack to remove debris from your floor cover as you roll it up

1248647	\$879 <sup>22</sup> EA
---------	------------------------



### STORAGE RACK COVER

- Keeps your floor cover and rack clean and hidden
- Custom lettering available - call for options and prices

**3 Year Limited Warranty**

1248401	\$374 <sup>22</sup> EA
---------	------------------------



### WALKWAY RUNNER MATS

- Heavy duty design for heavy traffic areas in hallways, foyers and in front of bleachers
- 1/8" thick durable vinyl runner with corrugated design promotes safety and protects your floor
- Runner mats are a great supplement to a gymnasium floor cover
- Available in **Black** 105' rolls

1237580	2'W x 105'L - 158 lbs.	\$479 <sup>22</sup> EA	
1237597	3'W x 105'L - 231 lbs.	\$579 <sup>22</sup> EA	
1237610	4'W x 105'L - 273 lbs.	\$719 <sup>22</sup> EA	

### FLOOR COVER TAPE DISPENSERS

- For floor cover tape up to 3" wide

1. 1270419	Hand Held	\$39 <sup>22</sup> EA
2. 1270426	Upright Walk Behind	\$374 <sup>22</sup> EA

### FLOOR COVER TAPE

- Secures overlaps and edges without leaving residue on floor or cover
- Purchase two cases of tape and receive a "FREE" walk behind tape dispenser (1 per customer)

3. 1270587	16 Rolls - 3" X 36 yds	\$169 <sup>22</sup> CASE
------------	------------------------	--------------------------

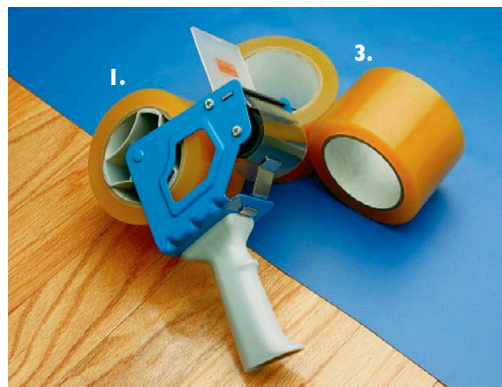

## DELUXE GYM FLOOR COVERS \*ADA Compliant\*

### BUILT TOUGH TO PROTECT YOUR INVESTMENT!

- Ultra-durable 3-ply fabrics
- Reinforcing polyester mesh yarns coated with PVC on both sides
- Seams are engineered to be as strong as the fabric itself (Meets Military and Dept. of Defense requirements)
- Use either side up - will lay smooth and flat
- Fabric is anti-bacterial, anti-fungal and rot and mildew resistant
- Meets stringent flame retardant standards including California Fire Marshall, NFPA 701 and UL 300
- Order in 10' wide sections adding 6" - 12" for overlapping
- Example: For a 75' x 110' floor, order 8 sections 10' x 110'

1369726	18 oz., 8 Yr. Warranty	\$0.75	SQ.FT.	
1048315	22oz., 10 Yr. Warranty	\$0.87	SQ.FT.	
1083743	27 oz., 15 Yr. Warranty	\$1.04	SQ.FT.	
1270433	32 oz., 17 Yr. Warranty	\$1.12	SQ.FT.	

18 oz. Color Options: **Black, Burgundy, Green, Kelly Green, Light Gray, Navy Blue, Orange, Red, Royal Blue, Tan, Yellow**

22 oz. Color Options: **Black, Brown/Tan, Burgundy, Green, Light Gray, Navy Blue, Red, Royal Blue, Tan, Tan/Royal Blue, Yellow**

27 & 32 oz. Color Options: **Black, Brown/Tan, Burgundy, Dark Gray, Green, Navy Blue, Red, Royal Blue, Tan, Tan/Burgundy, Tan/Royal Blue**

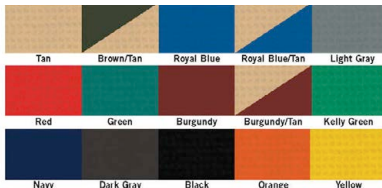

Actual colors may vary.



### FLOOR COVER LETTERING

- Customize your DELUXE floor covers with 1 or 2 color, 42" block letters

1270549	1 Color, 42"	\$79.99	EA	
1270556	2 Color, 42"	\$129.99	EA	

### PRO SHIELD GYM FLOOR COVER TILE

- Beautiful acoustic carpet tiles for all kinds of events
- No need for tape, tiles will lie flat and won't slide
- 100% solution-dyed polypropylene top surface and a non-staining polyolefin backing
- Lightweight for quick set up and breakdown
- Approximately 39 3/8" x 78 3/4" (22 lbs. per tile)

**3 Year Limited Warranty**

Color Options: **Blue, Grey.**

1384778	Specify Color	\$55.99	EA	
---------	---------------	---------	----	--

### PRO SHIELD GYM FLOOR TILE CART

- Stores and transports your gym floor cover tiles
- Steel frame with a carpeted plywood platform
- Features 5" casters and removable 29" handle
- 950 lb. capacity (70-80 tiles)

**3 Year Limited Warranty**

1384780	80"L x 43"W	\$849.99	EA	
---------	-------------	----------	----	--

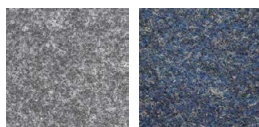

GREY

BLUE

## SAVE BY PURCHASING PRE-CUT COVERS!



### PRE-CUT GYM FLOOR COVERS \*ADA Compliant\*

- Durable, vinyl cover protects your gym floor during non-athletic events
- Covers are already cut to 10'W x 100'L sections

Color Options: **Royal Blue, Tan.**

1369718	18 oz., 8 Yr. Warranty	\$729.99	EA	
1162677	22 oz., 10 Yr. Warranty	\$839.99	EA	
1375308	27 oz., 15 Yr. Warranty	\$1,019.99	EA	
1375310	32 oz., 17 Yr. Warranty	\$1,099.99	EA	





**STIGA**  
**STS520 TABLE**

- 1" tournament blue top with silk screen lines
- 2 1/2" self opening, heavy duty steel legs with leg levelers and welded cross brace
- 2 1/2" powder coated, steel apron with full length ball storage and corner protectors
- 5" mag wheels with sports tread tires, single sided swing arms and 2 locking wheels
- 72" premium net and post system with tension adjustment and spring clip mounting
- Features an extra heavy-duty Euro design chassis for unmatched support
- Folds for playback and storage

1375131

\$999<sup>22</sup> EA 

**STIGA**  
**STS420 TABLE**

- 1" tournament blue top with silk screen lines
- 2 1/2" self opening, sturdy steel legs with leg levelers and welded cross brace
- 2 1/2" powder coated, steel apron with full ball storage and corner protectors
- 5" mag wheels with tread tires, single sided swing arms and 2 locking wheels
- 72" premium net and post system with tension adjustment and spring clip mounting
- Patented quickplay chassis for quick and easy assembly
- Folds for playback and storage

1375130

\$919<sup>22</sup> EA 

**STIGA**  
**STS385 TABLE**

- 3/4" tournament blue top with silk screen lines
- 2" self opening, heavy duty steel legs with leg levelers
- 2" powder coated, steel apron with ball storage and corner protectors
- 5" mag wheels with sports tread tires, single sided swing arms and 2 locking wheels
- 72" premium net and post system with tension adjustment and spring clip mounting
- Folds for playback and storage

1375129

\$799<sup>22</sup> EA 

**STIGA**  
**STS285 TABLE**

- 3/4" tournament blue top with silk screen lines
- 2" self opening steel legs
- 2" powder coated, steel apron with ball storage and corner protectors
- 3" mag wheels with sports tread tires, single sided swing arms and 4 locking wheels
- 72" pivoting net and post system with tension adjustments is integrated into the table to allow opening and closing without removing net
- Ready to play right out of the box - no assembly required
- Folds for playback and storage

1375128

\$679<sup>22</sup> EA 

**STIGA**  
**STS185 TABLE**

- 3/4" tournament blue top with silk screen lines
- 2" self opening steel legs
- 2" powder coated, steel apron with ball storage and corner protectors
- 3" mag wheels with sports tread tires, single sided swing arms and 2 locking wheels
- 72" pivoting net and post system with tension adjustments is integrated into the table to allow opening and closing without removing net
- Folds for playback and storage

1375127

\$579<sup>22</sup> EA 



**STIGA**
**INSTA PLAY TABLE**

- 3/4" Black top
- 2" steel support apron
- 2" square steel legs
- 3" ball bearing casters
- Heavy-duty chassis
- Includes 66" net and posts
- Corner pads for added protection
- Fully assembled - from box to play instantly
- Folds for playback and storage

1276176

 \$589<sup>22</sup> EA

**STIGA**
**THE DAYTONA TABLE**

- 5/8" Black top
- 1 1/2" steel apron for added support
- 1 1/2" round steel tube legs
- 3" mag wheel casters (2 with brakes)
- Rigid uni-body chassis for added strength
- Net and posts included
- Corner protection pads prevents snags
- From box to play in just minutes
- Folds for playback and storage
- **Paddles and balls not included**

1199550

 \$499<sup>22</sup> EA

**STIGA**
**CORONADO OUTDOOR TABLE**

- Aluminum composite top
- Welded steel support frame
- 1 1/2" steel legs
- 4" all-terrain mag wheel casters
- Oversized composite caster beam
- Patented Quickplay<sup>®</sup> chassis design
- Includes all-weather net and posts
- Molded corner protection pads with galvanized hardware
- Folds for playback and storage

1309225

 \$699<sup>22</sup> EA

**STIGA**
**TABLE COVER**

- Protect your table from unnecessary damage
- Durable PVC cover fits most tables
- Elastic hems keeps cover snug in play and storage positions

1375126

 \$29<sup>22</sup> EA



### TOURNAMENT BALLS

- Seamless ball for championship play
- 3-star - 40mm - White

**1035612** \$2<sup>22</sup> BOX OF 6 ★  
**1071160** \$60<sup>22</sup> GROSS OF 144 ★

### RECREATIONAL BALLS

- Durable, all around ball
- 1-star - 40mm - White

**1035605** \$2<sup>12</sup> BOX OF 6 ★  
**1071177** \$43<sup>22</sup> GROSS OF 144 ★

### STIGA DELUXE BALLS

- Top quality game ball
- 2-star - 40mm - White

**918XXXXX** \$65<sup>22</sup> GROSS OF 144



### STA-TITE CLAMPS AND NET

- Die-cast clamps are rigid and extra durable
- Large 1 3/4" head keeps clamp firmly in place
- No nuts, springs, etc. to work loose and lose
- Features a genuine Saran net which keeps its shape after stretching

**932XXXXX** 2 Clamps + 1 Net \$37<sup>22</sup> SET ★  
**932NXXXX** Net Only \$20<sup>22</sup> EA ★

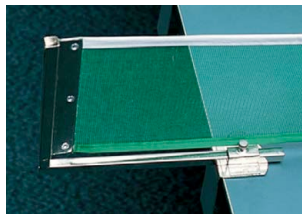

### CHAMPIONSHIP NET AND POST SET

- Slip on, heavy-duty, open mesh polyethylene net (72" long)
- Heavy-duty posts with extended net clamps

**NANPXXXX** \$20<sup>22</sup> SET ★



### ORANGE RECREATIONAL BALLS

- Durable, all purpose ball
- 40mm - Orange for greater visibility

**930** \$49<sup>22</sup> GROSS OF 144



### UNBREAKABLE PADDLE

- Plays like a rubber-padded paddle
- Felt cover won't peel off
- Indoor/outdoor use
- 2 Year Limited Warranty



**7696** Felt Face \$15<sup>22</sup> EA



### UNISTRUCTURE PADDLES

- This is the one you can drive nails with
- One-piece paddle won't delaminate like wood paddles
- Looks like wood but will outlast wood

**920E** Simulated Sand Face \$4<sup>22</sup> EA ★  
**920** Simulated Sand Face \$47<sup>22</sup> DZN ★  
**921E** Rubber Face \$5<sup>22</sup> EA ★  
**921** Rubber Face \$64<sup>22</sup> DZN ★



### PURE TABLE TENNIS RACQUET

- A Stiga 3 star product
- Concave handle with acrylic lens
- 5-ply rubber - 3-star rubber - 1.5mm sponge
- A great colorful racquet with unrivaled levels of power

#### 90 Day Limited Warranty

Color Options: **Blue, Green, Pink, Yellow.**

**1375146** Specify Color \$29<sup>22</sup> EA



### FLOW TABLE TENNIS RACQUET

- For indoor and outdoor play
- Designed to be weather and shock resistant
- Handle: Thermoplastic elastomers
- Face: Polypropylene and glass fibers

#### 90 Day Limited Warranty

Color Options: **Black, Green.**

**1375156** Specify Color \$22<sup>22</sup> EA



## PADDLES



### 1. ECONOMY SAND PAPER FACE

- Sand paper face

**NAS1XXXX** 5 ply \$3<sup>22</sup> EA ★

### 2. ECONOMY RUBBER FACE

- Pips out face

**NAR1XXXX** 5 ply \$4<sup>22</sup> EA ★

### 3. STANDARD SPONGE RUBBER 2MM

- Pips out face and tapered edging

**NAR2XXXX** 5 ply \$4<sup>22</sup> EA ★

### 4. STANDARD SPONGE RUBBER 2.2MM

- Pips out face, tapered edging and leather grip

**NAR3XXXX** 5 ply \$6<sup>22</sup> EA ★

### 5. DELUXE SPONGE RUBBER 1.5MM

- Pips in face and tapered edging

**NAF1XXXX** 5 ply \$6<sup>22</sup> EA ★

### 6. DELUXE SPONGE RUBBER 2MM

- Pips in face and tapered edging

**NAF2XXXX** 5 ply \$7<sup>22</sup> EA ★

### 7. DELUXE SPONGE RUBBER 2.2MM

- Pips in face, tapered edging and leather grip

**NAF3XXXX** 5 ply \$9<sup>22</sup> EA ★



**GLADIATOR FOOSBALL TABLE**

- Tournament quality table that is built to last
- 15" deep MDF cabinet with 2" thick sidewalls
- 3/4" MDF playing surface
- 4 3/4" square post style legs with levelers
- 5/8" solid steel rods and traditional style men
- 34 3/4"H x 31 1/4"W x 56"L
- Includes 4 balls and integrated cup holders
- Weighs 180 lbs. - assembly required

1375117

\$649<sup>99</sup> EA



**6 PACK OF FOOSBALLS**

- Replacement foosballs
- 30 Day Limited Warranty

1378324

\$9<sup>99</sup> PACK



**FOOSBALL PLAYERS w/HARDWARE**

- 6 players including attachment hardware
- 90 Day Limited Warranty
- Color Options: Black, Red.

1375152

Specify Color

\$13<sup>99</sup> PACK OF 6



**BALL DISPENSER**

- Put your table tennis and table soccer balls on a self sustaining basis
- Rugged steel and cast alloy base
- High-impact plastic globe holds 144 balls (not included)

NA936-25DS	\$.25 Slot Unit	\$179 <sup>99</sup> EA
941XXXXXDS	Dispenser Globe	\$39 <sup>99</sup> EA
937XXXXXX	Extra Key for Dispenser	\$7 <sup>99</sup> EA
NA936XXX	Dispenser Stand 27"H - Black	\$89 <sup>99</sup> EA

**SHUFFLEBOARD TABLE**



**SHUFFLEBOARD TABLE**

- Poly-Coated solid play surface for smooth, fast action
- Play area measures 14"W x 94 3/8"L
- Laminated cabinet and pedestal legs with levelers
- Abacus style scoring
- Includes 8 weights and 1 canister of wax
- Overall size: 31"H x 24 1/4"W x 108 1/4"L

1375124

220 lbs.

\$649<sup>99</sup> EA

**SHUFFLEBOARD ACCESSORIES**

**SHUFFLEBOARD TABLE CLEANER & POLISH**

- Removes dirt and produces high luster - 1 Qt.

NA7922XX

\$19<sup>99</sup> EA

**SHUFFLEBOARD POWDER WAX**

- Assures free-glide action, a must for table games - 16 oz. container

NA7924XX

\$12<sup>99</sup> EA

**SHUFFLEBOARD PASTE POLISH WAX**

- Produces hard protective coating to protect bed finish - 1 Qt.

NA7927XX

\$24<sup>99</sup> EA

**SHUFFLEBOARD TABLE WEIGHTS**

- 2" replacement weights
- 90 Day Limited Warranty
- Color Options: Blue, Red.

1379364

Specify Color



\$5<sup>99</sup> EA



**Mizerak**

**DAKOTA 8' POOL TABLE**

- 3/4" played
- Reinforced pedestal style legs with leg levelers
- 3 5/8" laminate top rails with full profile K66 nose rubber - provide uniform rebound and consistent play
- Wool blend cloth
- Features an internal ball return system
- Includes 2 cues, 1 set of balls, 1 triangle, chalk and table brush
- 31 1/4"H x 55"W x 99"L
- Assembly required



1375150 Slate - 683 lbs. \$1,499<sup>99</sup> EA   
 1375151 Slatron - 331 lbs. \$1,229<sup>99</sup> EA 



**Mizerak**

**DONOVAN 8' POOL TABLE**

- 3/4" played
- Reinforced pedestal style legs with leg levelers
- 3 5/8" Black laminate top rails
- Chrome corner posts and caps
- Full profile K66 cushions
- Deep Red wool/nylon blend cloth
- Internal drop pockets
- Includes 2 cues, 1 set of balls, 1 triangle, chalk and table brush
- 31 1/4"H x 55"W x 99"L
- Assembly required

1276497 Slate - 683 lbs. \$1,299<sup>99</sup> EA   
 1276503 Slatron - 331 lbs. \$1,149<sup>99</sup> EA 

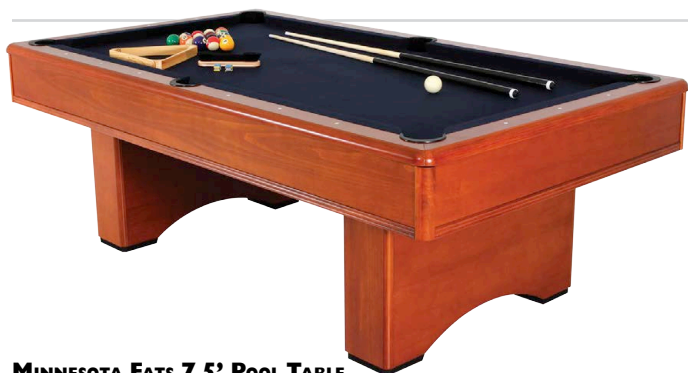

**MINNESOTA FATS 7.5' POOL TABLE**

- 1" Dur-A-Bond played
- Pedestal style legs with hidden leg levelers
- Cherry finish veneer on rails, apron and legs
- Wool blend cloth
- Concealed pockets
- 31"H x 50"W x 90"L
- Includes 2 cues, 1 set of balls, 1 triangle, chalk and table brush
- Assembly required

**90 Day Limited Warranty**

1388275 430 lbs. \$1,119<sup>99</sup> EA 



**Mizerak**

**DYNASTY 78" POOL TABLE**

- Space saver design fits into smaller areas
- Attractive bamboo laminate
- Automatic ball return provides easy access
- Pedestal style legs with cross support for added stability
- Large disk style leg levelers for leveling made easy
- Sealed MDF played with durable nylon cloth
- Includes: 2 cues, 1 set of balls, 1 triangle and 2 pieces of chalk
- Assembly required

1375125 283 lbs. \$669<sup>99</sup> EA 



**CLASSIC BUMPER POOL TABLE**

- 49 1/2" x 33 1/2" play field
- 5 1/8" square legs
- 5 7/8" top apron and 7 3/4" bottom apron
- Constructed of MDF with wood grain laminate
- Accessories Included: 1 set of bumper pool balls, 2 (48") cues, chalk and brush
- Overall Dimensions: 32"H x 41 1/2"W x 57 1/2"L
- Assembly required

1375121 274 lbs. \$629<sup>99</sup> EA 



**STIGA**

**POOL TABLE CONVERSION TOP**

- Convert your pool table into a table tennis table
- Fits 7" and 8" pool tables
- 1/2" thick Dark Green wood top
- 30" center-mounted steel stiffeners
- Side strips help align top properly
- Sponge rubber strips hold top firmly in place
- Net and post sold separately
- Approximately 100 lbs.

**STA-TITE CLAMPS AND NET**

- Die-cast clamps are rigid and extra durable
- Large 1 3/4" head keeps clamp firmly in place
- No nuts, springs, etc. to work loose and lose
- Features a genuine Saran net which keeps its shape after stretching

**932XXXXX** 2 Clamps + 1 Net \$37<sup>99</sup> SET ★

20020817 \$329<sup>99</sup> EA 

## BILLIARD ACCESSORIES



**MizeraK**

### BILLIARD ACCESSORY PACK

- Includes two 57" 2-piece cues, set of balls, one rack and six pieces of chalk

1138764

\$152<sup>99</sup> PACK



**CHALK**

**NACHK122**  
**NACHK144**

\$5<sup>99</sup> BOX OF 12 ★

\$49<sup>99</sup> BOX OF 144 ★



### SOLID WOOD ONE-PIECE CUES

**NAQ481XX**  
**NAQ521XX**

48" \$13<sup>99</sup> EA ★  
52" \$14<sup>99</sup> EA ★

Weight: 17 oz., 18 oz., 19 oz., 20 oz., 21 oz..

**NAQ57117** 57" - Specify Weight \$16<sup>99</sup> EA ★



### ALUMINUM CUES

- Warp-proof with wood-like polystyrene butt end
- Extremely tough and durable

**NA261XXX**  
**NA259XXX**

48" \$27<sup>99</sup> EA ★  
52" \$29<sup>99</sup> EA ★

Weight: 18 oz., 19 oz., 20 oz., 21 oz..

**NA260X** 57" - Specify Weight \$30<sup>99</sup> EA ★

### Screw In Tips For Wood & Aluminum Cues

**NASCRTIP**

\$11<sup>99</sup> DZN ★



### Slip-On Cue Tips

100 per set.  
Size: 11mm, 12mm, 13mm.

**NA252100**

\$29<sup>99</sup> BOX OF 100 ★

### Billiard Bridge Stick

- Hardwood bridge cue with 5 position aluminum bridgehead
- Helps reach shots anywhere on the table

**90 Day Limited Warranty**

**1378290**

\$21<sup>99</sup> EA



### BELGIAN PHENOLIC BILLIARD BALLS

- 2 1/4" - Screened on stripes and numbers
- Cue ball included

**NA270XXX**

\$99<sup>99</sup> SET ★

### 9-BALL RACK - PLASTIC

**NATRPL9X**

\$12<sup>99</sup> EA



### PLASTIC TRIANGLE 2 1/4"

**NATRPLXX**

\$9<sup>99</sup> EA ★



### 9" TABLE BRUSH

**NABRSH9X**

\$12<sup>99</sup> EA ★



### REPLACEMENT CLOTH

- 85% Wool, 15% Nylon, 20 oz. Green cloth

<b>NA232/7X</b>	For 7' Bed Pool Table	\$137 <sup>99</sup> EA
<b>NA232/8X</b>	For 8' Bed Pool Table	\$157 <sup>99</sup> EA
<b>NA232/9X</b>	For 9' Bed Pool Table	\$167 <sup>99</sup> EA
<b>NA232/4X</b>	For Bumper Pool Table	\$52 <sup>99</sup> EA
<b>NA233XXX</b>	Cushion Cloth	\$74 <sup>99</sup> EA
<b>NA233/4X</b>	Cushion Cloth For Bumper Table	\$62 <sup>99</sup> EA



### TABLE COVER

- Protects table from dirt and spills
  - Heavy-duty vinyl fits tables up to 8' long
  - 8" deep elastic box corners allow for snug fit
- 90 Day Limited Warranty**

**1375538**

\$15<sup>99</sup> EA



### BUMPER POOL BALLS

Set of Belgian Aramith® 2 1/8" high quality phenolic

**NA274XXX**

\$54<sup>99</sup> SET OF 10

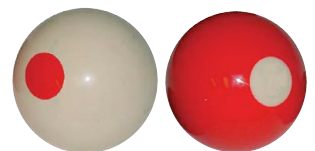



### 8' Air Powered Hockey Table

- Commercial grade blower maximizes air-flow eliminating dead spots
- Super slick, scuff resistant melamine surface for fast, smooth play
- Hide-away LED scoreboard with oversized numbers
- Solid 6" square leg posts with leg levelers for added stability
- Includes 4 strikers and 4 pucks
- Some assembly required
- 32"H x 50"W x 96"L - Weight: 400 lbs.

1296266

\$1,429<sup>99</sup> EA



### Blazer 7' Air Powered Hockey Table

- Heavy-duty 120V blower motor
- 3/4" gloss PVC laminated playing surface
- 4 1/2" MDF aprons
- Overhang rails to reduce puck bounce
- 6" pedestal style legs with 5" leg levelers
- Flip-up electronic scoring
- Includes (4) strikers and (4) 3" pucks
- Assembly required
- 32"H x 48"W x 84"L - Weight: 190 lbs.

1375118

\$659<sup>99</sup> EA



### Victory 6' Air Powered Hockey Table

- Heavy-duty 120V blower motor
- 3/4" PVC laminated playing surface
- 4 5/8" MDF aprons
- 6" pedestal style legs with 1 1/2" leg levelers
- Battery powered LED scoring
- Includes (2) strikers and (2) pucks
- Assembly required
- 32"H x 40"W x 72"L - Weight: 150 lbs.

1375119

\$499<sup>99</sup> EA



### 7' Flip Table

- Billiard Table - simply flip the top over - and you have an Air-Powered Hockey Table
- New locking mechanism - locks table top securely in place
- Billiard Table - high density MDF playbed
- Red nylon blend cloth
- Hockey Table - glossy PVC laminate playbed with 110V blower motor
- 3" solid rails and heavy-duty aprons
- 4 1/2" boxed and tapered legs with levelers
- Manual inlaid scoring
- Includes: 2 cues (48"L), 1 set of billiard balls, 1 rail brush, 1 triangle, 2 chalk, 2 strikers and 2 pucks
- Assembly required
- 32"H x 44"W x 90 1/4"L

1378531

\$829<sup>99</sup> EA



### TABLE HOCKEY ACCESSORIES

- Strikers and pucks for air powered hockey tables
- Colors vary

NA6107XX	2 Strikers & 2 (2 1/2") Pucks	\$17 <sup>99</sup> SET ★
I402XXXX	5 (2 1/2") Pucks	\$13 <sup>99</sup> SET OF 5 ★
I403XXXX	2 Strikers	\$11 <sup>99</sup> SET OF 2 ★
I404XXBM	3 (3") Pucks	\$13 <sup>99</sup> SET OF 3 ★



### ECONOMY CARROM® BOARD

- 28"W x 28"L wood frame with corner pockets
- Two-sided board plays 100+ games including Checkers, Carroms and Billiards
- Includes 44 playing pieces, 2 cues, number discs and instructions
- For ages 13 and up

**2850XXXX**

 \$99<sup>99</sup> SET

### REPLACEMENT CARROMS® SET

- Complete set of replacement equipment, excluding cues

**2852XXXX**

 \$18<sup>99</sup> SET

### POCKET GOLF

- 34"W x 50"L hardwood frame with steel corners
- Colorful silk-screened, coated surface
- Includes two 36" cue sticks and set of carroms®
- Up to 4 players enjoy all the excitement of real golf including sand traps and water hazards
- Recommended for ages 7 and up

**HMI2500XBM**

 \$219<sup>99</sup> EA ★

**HMI1004X**

Extra Playing Pieces

 \$6<sup>99</sup> SET OF 4 ★

### HEAVY DUTY MULTI-GAME BOARD

- 28 1/2" x 28 1/2" maple hardwood side rails, birch plywood playing surface and cast aluminum pockets
- Comes with two 24" hardwood cue sticks and 26 playing pieces
- Recommended for ages 7 and up

**HMI1000XBM**

 \$159<sup>99</sup> EA ★

**HMI1002XBM**

Extra Playing Pieces

 \$19<sup>99</sup> SET OF 26 ★

### DOUBLE SHOT BASKETBALL GAME

- The ultimate arcade style shootout for casual use
- Each goal equipped with infrared eyes for enhanced scoring accuracy
- Two player scoring and timing
- Heavy-duty MDF backboard and nylon netting
- Rectangular steel tube cage adds support and stability
- Includes 6 mini balls and inflator
- 88"H x 47"W x 89"L
- Weight: 200 lbs.

**90 Day Limited Warranty**

1375122

 \$569<sup>99</sup> EA

### DELUXE SHOOT OUT

- Designed for casual use
- Each goal equipped with infrared eyes
- Frame is 1 1/4" steel tubing
- Two player electronic scoring and timer
- Includes 4 mini basketballs and pump
- 89"H x 45"W x 106"L

**90 Day Limited Warranty**

1378530

 \$239<sup>99</sup> EA

## GAME BOARD ACCESSORIES

### GAME BOARD ACCESSORIES

**90 Day Limited Warranty**
**1362398**

24" Cue Stick

 \$9<sup>99</sup> PR

**HMI0360XBM**

36" Cue Stick

 \$22<sup>99</sup> PR ★

**NA7924XX**

Powder Wax

 \$12<sup>99</sup> EA

### QUADPODS

- Perfect for table top games
- Strong 1" steel legs pivot on steel pins mounted in the center block
- Rubber-tipped legs protect floor
- Folds and stores easily - weight: 9 lbs. - 36" tall
- For games 30" x 30" or larger (game not included)

**HM40230XBM**

36" Quadpod Sr.

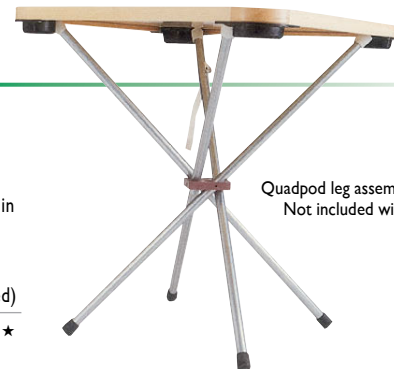
 \$64<sup>99</sup> EA ★

 Quadpod leg assembly sold separately.  
Not included with table top games.



**STANDARD PLAYING CARDS**

- Plastic coated, linen finish
- Packed per dozen
- Half Blue and half Red

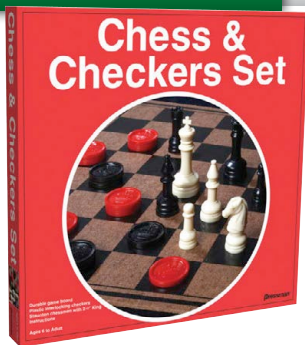
**NAPC-1XX** Poker \$27.99 DZN ★  
**NAPC-2XX** Pinoche \$27.99 DZN ★



**CHESS & CHECKERS SET**

- Combination chess and checkers
- Includes board, pieces and instructions

**NA636XXX** \$15.99 EA

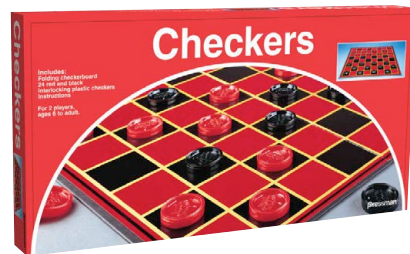

**CHECKERS SET**

- 15" x 15" folding board
- (24) 1 1/4" checkers

**NA637XXX** \$7.99 EA  
**2203XXXX** Checker Pieces Only \$4.99 SET

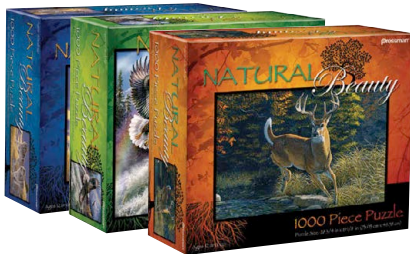

**PUZZLES - 1000 PIECES**

- 6 puzzles with 3 assorted scenes
- All 3 scenes are duplicated (total of 6)

**1369717** \$36.99 PACK OF 6

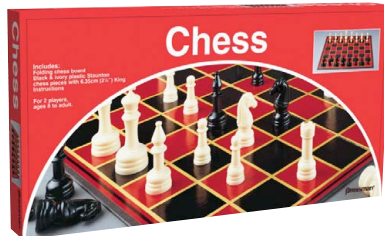

**CHESS SET**

- 15" x 15" folding board
- (32) plastic chess pieces

**2261XXXX** \$8.99 SET  
**2204XXXX** Chess Pieces Only \$6.99 SET

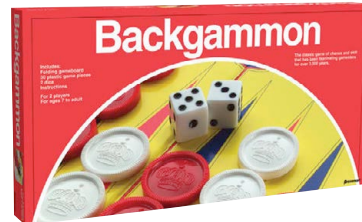

**ECONOMY BACKGAMMON**

- 15" x 15" folding board
- Includes 30 playing pieces, 2 pair of dice, and instructions
- For 2 players ages 7 and up

**2245XXXX** \$10.99 EA



**CLASSIC BINGO SET**

- 8.5" diameter metal cage on sturdy stand
- Complete with 50 bingo cards, 1000 assorted color markers, 75 wooden balls and 1 master board
- For 2 or more players ages 7 and up

**NA646XXX** \$79.99 SET



**UNO CARD GAME**

- Yell UNO! when you have only one card left
- America's #1 card game
- Includes 108 cards
- 2 to 10 players ages 7 and up

**4036XXXX** \$10.99 EA



**WOOD CRIBBAGE WITH CARDS**

- Players use card combinations to peg points along the wood board
- Includes wood cribbage board with storage compartment, compartment cover, 9 pegs, deck of cards and instructions
- For 2 or 3 players, ages 8 and up

**1244335** \$12.99 EA



**CHESS/CHECKERS/BACKGAMMON SET**

- Three classics in one box!
- Double sided game board, 30 plastic checkers, Staunton chess pieces, dice and instructions
- For 2 players, ages 8 and up

**1238228** \$10.99 EA



**DELUXE DOUBLE SIX DOMINOES WITH CASE**

- 28 jumbo crystalline dominoes, vinyl case and rules
- For 2 to 4 players ages 7 and up

**1238211** \$16.99 EA



**DOUBLE SIX DOMINOES**

- 28 solid, hardwood dominoes
- For 2 to 4 players ages 7 and up

**2240XXXX** \$6.99 EA



**DOUBLE NINE DOMINOES**

- 55 large, solid hardwood dominoes
- For 2 to 7 players ages 7 and up

**2552XXXX** \$8.99 EA



**DELUXE TRI-OMINOS**

- The classic triangular domino game
- Score points by matching numbers on the three sided tiles with brass spinners
- For 2 to 4 players ages 8 and up

**2302XXXX** \$22.99 EA



Board Game Graphics subject to Change



**BATTLESHIP**

- Plan your strategy and sink your opponent's ships
- For 2 players ages 7 and up

4020XXXX

\$29<sup>99</sup> EA



**CANDYLAND**

- Classic beginner game
- For 2-4 players ages 3-6

4019XXXX

\$17<sup>99</sup> EA

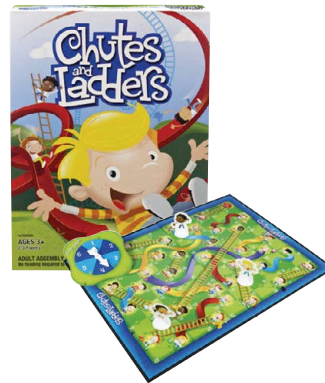

**CHUTES AND LADDERS**

- Up the ladders and down the chutes
- For 2-4 players ages 3-7

4018XXXX

\$15<sup>99</sup> EA



**CONNECT FOUR**

- Five games in one
- For 2 players ages 7 and up

4071XXXX

\$26<sup>99</sup> EA



**JENGA**

- Keep the tower from falling
- For 1 or more players ages 6 and up

4793XXXX

\$23<sup>99</sup> EA



**MONOPOLY**

- The classic game of buying and selling
- For 2 to 8 players ages 8 and up

4034XXXX

\$29<sup>99</sup> EA

1371283

Monopoly Deal  
Card Game \$7<sup>99</sup> EA



**MONOPOLY ELECTRONIC GAME**

- The classic game of buying and selling electronic version
- Requires 2 AAA batteries not included
- For 2-6 players ages 8 and up

1375317

\$37<sup>99</sup> EA



**RISK**

- Rally your armies to march across continents
- Keep advancing until you've taken over the world!
- For 2 to 5 players ages 10 and up

4037XXXX

\$47<sup>99</sup> EA



**SCRABBLE**

- Classic crossword game
- For 2 to 4 players ages 8 and up

4044XXXX

\$29<sup>99</sup> EA

1371282

Scrabble Slam  
Card Game \$7<sup>99</sup> EA



**SORRY!**

- Bump, slide and switch until somebody gets all the way home
- For 2 to 4 players ages 6 and up

4042XXXX

\$30<sup>99</sup> EA



**TRIOPOLEY DELUXE**

- A fast-paced, 3-in-1 challenge in which players use a single card hand to play a round of Michigan Rummy, Hearts and Poker
- For 2 or more players ages 8 and up

1255713

\$18<sup>99</sup> EA



**YAHTZEE**

- Throw the dice to build straights, full houses, 5 of a kind - Yahtzee
- For 1 or more players ages 8 and up

4024XXXX

\$15<sup>99</sup> EA

4025XXXX

80 Replacement  
Score Cards \$5<sup>99</sup> EA

<b>Mancala</b>	2401XXXX	\$18 <sup>99</sup> EA
<b>Clue</b>	4038XXXX	\$29 <sup>99</sup> EA
<b>Monopoly Junior</b>	4919XXXX	\$21 <sup>99</sup> EA
<b>Game of Life</b>	4011XXXX	\$31 <sup>99</sup> EA
<b>Memory</b>	4073XXXX	\$15 <sup>99</sup> EA
<b>Guess Who®</b>	1159998	\$19 <sup>99</sup> EA

<b>Operation</b>	4078XXXX	\$28 <sup>99</sup> EA
<b>Perfection®</b>	1160000	\$14 <sup>99</sup> EA
<b>Rook</b>	4714XXXX	\$8 <sup>99</sup> EA
<b>Scrabble Dictionary</b>	4915XXXX	\$11 <sup>99</sup> EA
<b>Trouble</b>	4023XXXX	\$20 <sup>99</sup> EA
<b>Twister</b>	4072XXXX	\$30 <sup>99</sup> EA



## 24 Designer Colors



### LOCKERS

#### Standard Locker Features

- HD steel, electrically welded frame construction
- Powder coat baked enamel finish
- 1" steel top and bottom channels
- Recessed handles (ADA compliant)
- Full loop 5-knuckle design hinges welded to door frame, securely riveted to doors
- Ventilating louvers
- Coat hooks
- Number plates (up to four numerals)
- 6" legs
- Shipped unassembled with complete instructions

#### 1. SINGLE TIER

72"H x 12"W x 18"D (size of opening)

1053210	3 Wide - 3 Openings	\$549 <sup>22</sup>	SET OF 3	
1053371	1 Wide - 1 Opening	\$229 <sup>22</sup>	EA	

#### 2. DOUBLE TIER

36"H x 12"W x 18"D (size of opening)

1053531	3 Wide - 6 Openings	\$649 <sup>22</sup>	SET OF 6	
1053692	1 Wide - 2 Openings	\$269 <sup>22</sup>	EA	

#### 3. MULTI TIER

12"H x 12"W x 12"D (size of opening)

1053852	3 Wide - 18 Openings	\$699 <sup>22</sup>	SET OF 18	
1054019	1 Wide - 6 Openings	\$299 <sup>22</sup>	EA	



### STADIUM LOCKERS

- Ideally suited for athletic team rooms or anywhere easy access to uniforms and/or equipment is required
- Open front and visually perforated sides create full ventilation
- Made from prime grade mild cold rolled sheet steel, powder coat finish and painted the same color inside and out
- 72"H x 24"W with your choice of 18" or 24" depths and 4 different configurations

#### 72"H x 24"W x 18"D

1246186	With Shelf	\$374 <sup>22</sup>	EA	
1246391	With Shelf and Security Box	\$409 <sup>22</sup>	EA	
1246735	With Shelf and Footlocker	\$529 <sup>22</sup>	EA	
1246940	With Shelf, Footlocker and Security Box	\$624 <sup>22</sup>	EA	

#### 72"H x 24"W x 24"D

1247152	With Shelf	\$416 <sup>22</sup>	EA	
1247367	With Shelf and Security Box	\$519 <sup>22</sup>	EA	
1247572	With Shelf and Footlocker	\$579 <sup>22</sup>	EA	
1247787	With Shelf, Footlocker and Security Box	\$676 <sup>22</sup>	EA	

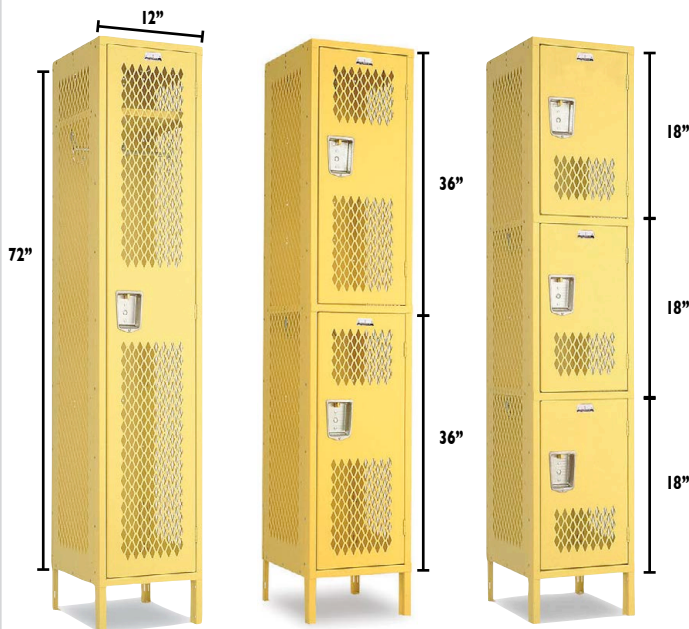

### ATHLETIC LOCKERS

- Constructed from heavy gauge steel
- Doors and sides are perforated allowing maximum air circulation while maintaining security
- Includes a stainless steel recessed handle and multi-point latching
- Lockers can be built in small groups and then placed into long rows
- To end a group or row of lockers, order either a perforated or solid 16 gauge group end (for solid group ends on lockers with common perforated sides, be sure to order a solid end for each row end)
- All units are 72"H x 12"W x 18"D

1215656	Single Tier	\$289 <sup>22</sup>	EA	
1215854	Double Tier	\$339 <sup>22</sup>	EA	
1216059	Triple Tier	\$374 <sup>22</sup>	EA	
1216257	Perforated End	\$114 <sup>22</sup>	EA	
1216455	Solid End	\$114 <sup>22</sup>	EA	

## Master Lock

### BlockGuard Anti-Shim Technology

- Unique flat latch technology that actually blocks typical shimming tools from opening the lock – deterring break-ins
- Hardened steel shackle resists cutting and prying
- Double-reinforced stainless steel case with cold-rolled steel construction shields locking mechanism from physical attack
- Thousands of possible combinations
- Dial automatically locks under shackle tension to prevent “feeling out” of combination
- Combination automatically scrambles when closed to prevent accidental opening
- Fits lockers with a padlock eye of at least 5/16” (8 mm) diameter



	DESCRIPTION	LOCK TYPE	CASE	SIZE	CODE	PRICE
1.	Padlock	Keyed alike, all-purpose double locking shackle with 2 brass keys	Solid body construction, brass cylinders	1-1/2" wide, 3/4" thick, 1" hardened steel shackle	20027893	\$13 <sup>22</sup> EA
2.	Combination lock - keyless	Combination - no keyway	Stainless steel body, black dial	7/8" hardened steel shackle	20021502	\$8 <sup>22</sup> EA
3.	Master lock 1525 (Specify color/series)	Keyed alike combination locks (Keys sold sep.)	Stainless Steel body, Specify Color and Keyway	7/8" hardened steel shackle	MSLK1525	\$9 <sup>22</sup> EA
4.	Master combination lock-Ka v69 series	Keyed alike combination locks (Keys sold sep.)	Stainless Steel Body, Black, Blue, Green or Red Dial	7/8" hardened steel shackle	1022858	\$9 <sup>22</sup> EA
5.	Control keys - specify keyway				20029474	\$5 <sup>42</sup> EA

## WADDELL

a GMI company

### TROPHY CASES

- Classic styled, durable, hardwood cases
- Sliding tempered safety glass doors, built-in locks and levelers, white laminate backs and the full length is available with an optional cornice light fixture
- Available finishes: Cordovan, Danish Walnut or Honey Maple (Oak finish is available for an extra charge)
- Free remembrance plaque (not engraved) also available on request
- Mirrored or plaque fabric backs are available for an extra charge
- Overall measurements include a 10" base
- Light fixture adds 6" to height of 70" case

PTA949XX	40"H x 36"W x 14"D - 112 lbs.	\$899 <sup>22</sup> EA	
3421XXXX	70"H x 48"W x 18"D - 243 lbs.	\$1,879 <sup>22</sup> EA	
PTA8931X	Light Fixture For 70"H Case	\$419 <sup>22</sup> EA	



## WADDELL

a GMI company

### SPIRIT DISPLAY CASE

- Display all of your achievements in these vibrant color cases
- Anodized aluminum framing with a 12" base cabinet
- Features sliding tempered glass doors and (4) 14" deep half shelves with brackets
- Built-in locks and levelers
- 72"H x 16"D
- Optional cornice/lighting fixture available in 10 colors
- Please specify color of frame, base and back panel
- Backing Color Options: **Plaque, White**
- Base Color Options: **Black, Forest Green, Gold, Kelly Green, Maroon, Navy, Orange, Purple, Red, Royal**
- Frame Color Options: **Bronze, Gold, Satin.**

1364410	1) 48"W Display Case	\$2,089 <sup>22</sup> EA	
1364470	2) 60"W Display Case	\$2,399 <sup>22</sup> EA	
1364630	48"W Cornice/Lighting Fixture	\$389 <sup>22</sup> EA	
1364640	60"W Cornice/Lighting Fixture	\$449 <sup>22</sup> EA	



### BULLETIN BOARD

- Satin aluminum frame
- 36"H x 48"W with natural cork display area
- Includes 2 key lock shatter-resistant acrylic doors

1162806

\$469<sup>22</sup> EA



2.



## HEAVY DUTY RECTANGULAR TABLE

- 6', 8', 10' and 12' lengths available
- 2-3/8" diameter all welded frame with powder coat finish
- Diamond and Perforated patterns available
- 1 or 2 sided ADA 8' versions
- Table is both Portable and Surface Mount (mounting hardware not included)

**5 Year Limited Warranty**



Wide Walk Through Design for Easy Entry & Exit



SIZE	STYLE	DIAMOND	PERFORATED	PRICE EA.	DELIVERY
6'	Walk-thru	1275353	1275360	\$1,049 <sup>22</sup>	
8'	Walk-thru	1275377	1275384	\$1,149 <sup>22</sup>	
8' ADA	Double sided	1275438	1275445	\$1,049 <sup>22</sup>	
8' ADA	Single sided	1275452	1275469	\$1,049 <sup>22</sup>	
10'	Walk-thru	1275391	1275407	\$1,479 <sup>22</sup>	
12'	Walk-thru	1275414	1275421	\$1,549 <sup>22</sup>	

## THE THERMOPLASTIC ADVANTAGE!

- High thermal stability keeps seats and tables cooler
- More corrosion and rust-resistant than other coatings
- Products are more durable and last longer
- FDA approved non-stick surface confidence in user safety for food contact



### 46" SQUARE AND ROUND TABLES

- 1-5/8" diameter steel frame with powder coat finish
  - Diamond and Perforated patterns available
  - Portable and/or Surface Mount (mounting hardware not included)
  - Includes center umbrella hole
- 5 Year Limited Warranty**



SIZE	STYLE	DIAMOND	PERFORATED	PRICE EA.	DELIVERY
46"	Square	1275476	1275483	\$1,049 <sup>22</sup>	
46"	Round	1275490	1275506	\$1,099 <sup>22</sup>	

### RECTANGULAR PEDESTAL TABLE

- 4' and 6' lengths available
  - Heavy-duty 4" square steel center post
  - 3" square steel support arm posts
  - Diamond and Perforated patterns available
  - In-Ground or Surface Mount
  - ADA compliant
- 5 Year Limited Warranty**



SIZE	PATTERN	IN-GROUND	SURFACE MOUNT	PRICE EA.	DELIVERY
4'	Diamond	1275513	1275520	\$1,099 <sup>22</sup>	
4'	Perforated	1275537	1275544	\$1,249 <sup>22</sup>	
6'	Diamond	1275551	1275568	\$1,279 <sup>22</sup>	
6'	Perforated	1275575	1275582	\$1,379 <sup>22</sup>	

## THERMOPLASTIC & POWDER COAT COLOR OPTIONS:

Tables, benches & receptacles feature rounded corners with either diamond expanded or perforated pattern. All items can be coated with any color shown here.

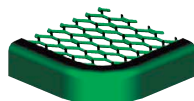

Diamond Expanded

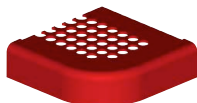



Perforated

- BLACK
- BROWN
- GREEN
- DARK BLUE
- BURGANDY
- BLUE
- RED
- BEIGE



**HEAVY DUTY PICNIC TABLES**

- 6' and 8' lengths available
- 2-3/8" diameter all welded walk through frame
- Pressure treated pine or aluminum plank options available
- 1 or 2 sided ADA 8' versions
- Pre-drilled holes for Portable and Surface Mount (mounting hardware not included)
- Made in the USA

SIZE	STYLE	PRESSURE TREATED		ALUMINUM	
		 PRICE	PRICE	 PRICE	PRICE
6'	Walk-thru	1275995	\$599 <sup>22</sup>	1276039	\$899 <sup>22</sup>
8'	Walk-thru	1276008	\$649 <sup>22</sup>	1276046	\$1,049 <sup>22</sup>
8' ADA	Double sided	1276015	\$649 <sup>22</sup>	1276053	\$1,049 <sup>22</sup>
8' ADA	Single sided	1276022	\$649 <sup>22</sup>	1276060	\$1,049 <sup>22</sup>



8' Pressure Treated Table

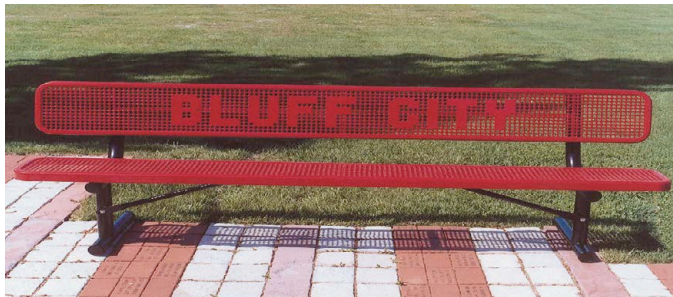



1275629 - 8' Perforated portable bench with punched custom lettering

**THERMOPLASTIC BENCHES W/CUSTOM LETTERING**

- Benches and receptacles can be customized with either punched or laser-cut lettering for a specialized look
- Custom lettering is available for both benches and trash receptacle below.
- Available colors: Black, Brown, Green, Dark Blue, Burgundy, Light Blue, Red and Beige
- Call for lettering details

5 Year Limited Warranty

SIZE	PORTABLE	IN-GROUND	SURFACE MOUNT	PRICE EA.	DELIVERY
6'	1275599	1275605	1275612	\$849 <sup>22</sup>	
8'	1275629	1275636	1275643	\$899 <sup>22</sup>	

\*Price includes custom lettering





Laser Cut Lettering  
1275667 - 5' Lexington Wave Bench

Entire bench (frame included)  
available only in one thermoplastic finish

**LEXINGTON WAVE BENCH**

- Benches and receptacles can be customized with either punched or laser-cut lettering for a specialized look.
- Custom lettering is included
- 12 letter spaces maximum for 4' benches
- 18 letter spaces maximum for 6' benches

- 5 Year Limited Warranty

1275650	4' Portable and/or Surface Mount	\$1,399 <sup>22</sup> EA	
1275667	6' Portable and/or Surface Mount	\$1,599 <sup>22</sup> EA	



6' Bench w/Back - Diamond

**ULTRACOAT™ THERMOPLASTIC COATED BENCHES**

- 6' and 8' lengths available
- 12" wide seat
- Diamond and Perforated patterns available
- All welded frame made from 2-3/8" O.D. pipe
- Made in the USA

5 Year Limited Warranty

BENCH WITH BACK SUPPORT 				
SIZE	PORTABLE	IN-GROUND	SURFACE MOUNT	PRICE EA.
6' DIA.	1275759	1275797	1275834	\$699 <sup>22</sup>
6' PERF.	1275766	1275803	1275841	\$749 <sup>22</sup>
8' DIA.	1275773	1275810	1275858	\$769 <sup>22</sup>
8' PERF.	1275780	1275827	1275865	\$799 <sup>22</sup>



6' Bench - Perforated

BENCH WITHOUT BACK SUPPORT 				
SIZE	PORTABLE	IN-GROUND	SURFACE MOUNT	PRICE EA.
6' DIA.	1275872	1275919	1275957	\$699 <sup>22</sup>
6' PERF.	1275889	1275926	1275964	\$749 <sup>22</sup>
8' DIA.	1275896	1275933	1275971	\$769 <sup>22</sup>
8' PERF.	1275902	1275940	1275988	\$799 <sup>22</sup>



**32 Gallon Trash Receptacle - Diamond**



**32 Gallon Trash Receptacle - Perforated**



**Dome Lid**

**Rain Bonnet Lid**



**32 Gallon Custom Laser Cut Trash Receptacle**

**THERMOPLASTIC TRASH RECEPTACLES**

- 32 gallon trash receptacle is available in Diamond or Perforated patterns.
  - Plastic liner and lids sold separately.
  - Available colors: Black, Brown, Green, Dark Blue, Burgundy, Light Blue, Red and Beige.
- 5 Year Limited Warranty**

1275698	Diamond - Specify Color	\$379 <sup>22</sup> EA		1275728	Flat Lid (8" Opening) - Specify Color	\$149 <sup>22</sup> EA	
1275704	Perforated - Specify Color	\$489 <sup>22</sup> EA		1275735	Rain Bonnet - Specify Color	\$189 <sup>22</sup> EA	
1275711	Dome Lid - Black	\$149 <sup>22</sup> EA		1275742	Plastic Liner - Black	\$79 <sup>22</sup> EA	

**CUSTOM TRASH RECEPTACLES**

1275674	Diamond Pattern	\$649 <sup>22</sup> EA	
1275681	Perforated	\$799 <sup>22</sup> EA	

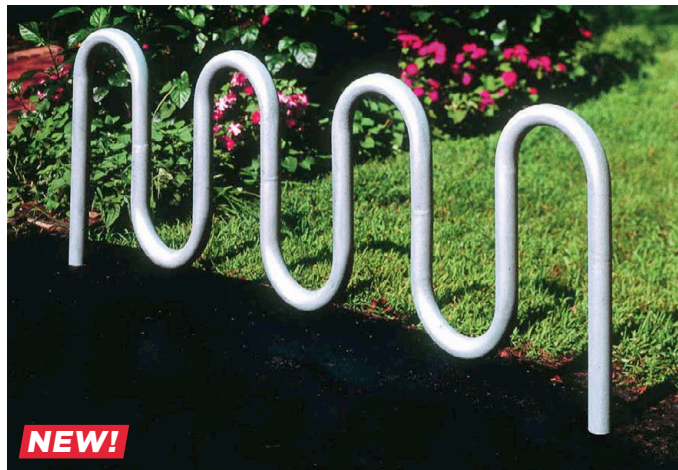

**NEW!**

**CONTEMPORARY BIKE RACKS**

- All one piece - no assembly required
  - Comprised of 2 3/8"OD steel tubing
  - Available as in ground design or surface mount (mounting hardware not included)
- 5 Year Limited Warranty**

**7 loop Bike Rack**

1375247	1 Loop - 2 Bike - In ground design	\$219 <sup>22</sup> EA	
1375249	1 Loop - 2 Bike - Surface mount design	\$219 <sup>22</sup> EA	
1375250	3 Loop - 5 Bike - In ground design	\$399 <sup>22</sup> EA	
1375251	3 Loop - 5 Bike - Surface mount design	\$439 <sup>22</sup> EA	
1375252	5 Loop - 7 Bike - In ground design	\$449 <sup>22</sup> EA	
1375253	5 Loop - 7 Bike - Surface mount design	\$489 <sup>22</sup> EA	
1375254	7 Loop - 9 Bike - In ground design	\$519 <sup>22</sup> EA	
1375255	7 Loop - 9 Bike - Surface mount design	\$559 <sup>22</sup> EA	
1375256	9 Loop - 11 Bike - In ground design	\$649 <sup>22</sup> EA	
1375257	9 Loop - 11 Bike - Surface mount design	\$709 <sup>22</sup> EA	

**TRADITIONAL BIKE RACKS**

- Available as either in-ground, portable or surface mount design (mounting hardware not included)
  - Constructed of 1 5/8"OD steel
  - 5/8"OD rung bars
  - All zinc plated hardware
- 5 Year Limited Warranty**



**5' Double-Sided Bike Rack**

1375258	5' Single sided - In ground	\$469 <sup>22</sup> EA	
1375259	5' Single sided - Portable	\$449 <sup>22</sup> EA	
1375260	5' Single sided - Surface Mount	\$509 <sup>22</sup> EA	
1375261	8' Single sided - In ground	\$539 <sup>22</sup> EA	
1375262	8' Single sided - Portable	\$519 <sup>22</sup> EA	
1375263	8' Single sided - Surface Mount	\$579 <sup>22</sup> EA	
1375264	10' Single sided - In ground	\$599 <sup>22</sup> EA	
1375265	10' Single sided - Portable	\$579 <sup>22</sup> EA	
1375266	10' Single sided - Surface Mount	\$639 <sup>22</sup> EA	
1375267	5' Double sided - In ground	\$499 <sup>22</sup> EA	
1375268	5' Double sided - Portable	\$479 <sup>22</sup> EA	
1375269	5' Double sided - Surface Mount	\$519 <sup>22</sup> EA	
1375270	8' Double sided - In ground	\$599 <sup>22</sup> EA	
1375271	8' Double sided - Portable	\$579 <sup>22</sup> EA	
1375272	8' Double sided - Surface Mount	\$639 <sup>22</sup> EA	
1375273	10' Double sided - In ground	\$709 <sup>22</sup> EA	
1375274	10' Double sided - Portable	\$689 <sup>22</sup> EA	
1375275	10' Double sided - Surface Mount	\$739 <sup>22</sup> EA	

**HITCH POST BIKE RACKS**

- Classic Bollard style rack for settings tight on space
  - Capacity up to two bikes
  - 36"H x 20"W
  - 2 3/8"OD 12 gauge galvanized steel tubing
  - Rings are 1 5/16" 14 gauge zinc tubing
- 5 Year Limited Warranty**



1375276	In-ground	\$189 <sup>22</sup> EA	
1375277	Surface Mount	\$199 <sup>22</sup> EA	

**HORSESHOE BIKE RACKS**

- Blends elegance with practicality
  - Capacity up to two bikes
  - 37"H x 42"W
  - Framework is 1.9"OD - 11 gauge galvanized steel tubing
- 5 Year Limited Warranty**



1375278	In-ground	\$379 <sup>22</sup> EA	
1375279	Surface Mount	\$419 <sup>22</sup> EA	



4' Hamilton Bench

**HAMILTON SERIES BENCHES**

- 4' and 6' lengths
- Vertical slats
- Framework is fully welded 1" x 1" solid steel
- Ships fully assembled
- **5 Year Limited Warranty**

1375280	4' Bench with back	\$1,549 <sup>22</sup> EA	
1375281	6' Bench with back	\$1,599 <sup>22</sup> EA	
1375282	4' Bench without back	\$1,249 <sup>22</sup> EA	
1375283	6' Bench without back	\$1,349 <sup>22</sup> EA	

**Powder Coat Color Options:**



6' Hamilton Bench w/Back



**PIONEER GRILL**

- A great all around campfire grill
- Four strong support bars combined with chrome plated, thick gauged steel wire
- Permanently attached and rigidly braced legs fold flat
- 12 1/2"W x 24"L with 12" legs
- **Must order in increments of 6 each**

1376522	\$20 <sup>22</sup> EA
---------	-----------------------



**FIRE RING**

- 30" diameter ring is 3/16" thick steel and has a 1" formed flange around the top for extra rigidity
- 15" x 20" grate offers 300 sq inches of cooking space and is 1/2" steel rods welded on 1" centers
- Easy flip-up grate has cool spring handles
- 7" high tilt back hinges on 1/2" dia. staple rods for easy clean out
- Painted with a non-toxic, heat and rust-resistant black enamel
- Weight: 69 lbs.

1376523	69 lbs.	\$199 <sup>22</sup> EA
---------	---------	------------------------



**CAMPFIRE RING & GRILL**

- A combination grill and fire ring
- Coil grip handles allow easy movement of the sliding grill for heat control and fire building
- The non-removable grill is made of 1/2" round bars on 1 1/8" centers
- Cooking surface is 15 1/2" x 18 1/2" providing 286 square inches
- The fire box and fire ring are made of 3/16" steel
- Fire box measures 21"W x 10"H x 15"D
- The three piece fire ring is 6"H x 29" side to side x 33" front to back including the fire box

1376524	79 lbs.	\$199 <sup>22</sup> EA
---------	---------	------------------------



**ROTATING FLIPBACK GRILL**

- 280 sq. inches of cooking area
- Cool coil handles
- Adjustable to 4 different levels
- Easy cleanup and fire building
- High temp. powder coat finish
- Mounts in-ground

1276077	2-3/8" Post	\$249 <sup>22</sup> EA	
1276084	3-1/2" Post	\$269 <sup>22</sup> EA	



**ADA ACCESSIBLE GRILL**

- Same specs. as Rotating Flipback Grill
- 3-1/2" post
- ADA accessible at 28" height

1276091	280 sq. inch Cooking Area	\$249 <sup>22</sup> EA	
1276107	300 sq. inch Cooking Area	\$269 <sup>22</sup> EA	



**BI-LEVEL GRILL**

- 1008 square inches of cooking area
- Utility shelf, grate adjusts to 4 different levels
- 4" square post
- High temp. powder coat finish

1276114	In-Ground	\$729 <sup>22</sup> EA	
1276121	Surface Mount	\$799 <sup>22</sup> EA	



## MacGregor

### 4' x 2' MULTISPORT INDOOR SCOREBOARD

- 6" LED numerals with 3 digit scoring, digital periods, bonus and possession indicators, (fouls can be kept on controller) last minute counts down in 1/10th seconds
- Durable plastic cabinet with plexiglass face
- Scores basketball, volleyball, wrestling and can function as a stopwatch or clock
- Includes rechargeable wireless remote control with 300' range and 12 frequency settings for operating multiple units independently in the same area
- Controller changes sports easily and can turn scoreboard on and off remotely
- Built in wall mount slots or use with portable stand (sold separately)
- Includes 100' of power supply cord for scoreboard
- Weight: 24 lbs.
- Assembled stand measures 60"H x 56"W x 31"D

# \$999<sup>99</sup>

SK3048 ★ Complete Unit

OPTIONS		
1317107	Optional Stand	\$199 <sup>99</sup> EA ★
1375095	Replacement Remote	\$199 <sup>99</sup> EA ★



**NEW!**

### COUNT DOWN TO GAME DAY CLOCK

- Count down to game time in Days, Hours, Minutes and Seconds
- 2-1/4" bright LED digits for easy viewing
- Quick and easy set up
- Change out customer supplied graphics for each event
- Hinged front window allows for easy access to event panel
- Graphics window size - 26"W x 11"H

1388090 Cabinet Size - 28"W x 22"H \$399<sup>99</sup> EA ★



**SIDE CONTROL PANEL**



**BEST SELLER**

Built in control panel



### INDOOR TABLETOP SCOREBOARD

- Dimensions: 16"H x 24"W x 10"D - 13 lbs.
- LED clock digits: 4.75" , LED score digits: 4.25"
- Scores basketball, volleyball and wrestling and can function as a metronome, stopwatch, clock with alarm and program timer
- Included wireless remote (100' range) allows operator to change score and start/stop the clock
- 4 user-programmable frequency settings for operating multiple units independently in the same area
- Includes digital periods, bonus, team fouls and possession indicators
- Indoor use only
- Optional assembled stand measures 43"H x 28"W x 28"D

**SK2229R** Indoor Tabletop Scoreboard \$499<sup>EE</sup> EA ★

#### OPTIONS

<b>1293784</b>	Wheeled Stand	\$99 <sup>EE</sup> EA ★
<b>1240597</b>	Extra Loud Horn	\$63 <sup>EE</sup> EA ★
<b>1142266</b>	Carry Bag	\$74 <sup>EE</sup> EA ★
<b>1201789</b>	Replacement Remote	\$53 <sup>EE</sup> EA ★
<b>1167443</b>	Replacement Power Cord/Adaptor	\$24 <sup>EE</sup> EA ★



### WIRELESS SHOTCLOCKS & CONTROLLER

Module included for use with the SK2229R or SK999 tabletop scoreboards

- Dimensions: 20"H x 15"W x 7"D - 12 lbs. ea
- 8" LED shot clock digits (300' viewing distance) 4.7" game clock digits
- Power supplied by built-in rechargeable batteries or 110v AC power cord
- Built in horns
- Assembled stand measures 48"H x 16"W x 26"D

**1171525** \$819<sup>EE</sup> SET ★

#### OPTIONS

<b>1171556</b>	Optional Stand	\$99 <sup>EE</sup> EA ★
<b>1167443</b>	Replacement Power Cord/Adaptor	\$24 <sup>EE</sup> EA ★
<b>1171570</b>	Replacement Battery	\$39 <sup>EE</sup> EA ★

Built in control panel



### INDOOR/OUTDOOR TABLETOP SCOREBOARD

Same as our popular SK2229R tabletop scoreboard with the following added features:

- Dimensions: 16"H x 24"W x 10"D - 24 lbs.
- Dual LED setting for indoor and outdoor brightness
- AC/DC, with built-in rechargeable battery (up to 6 hour battery life depending on brightness setting)
- Portable use only (do not store outside or use during inclement weather)
- Assembled stand measures 43"H x 28"W x 28"D

**SK999** Tabletop Scoreboard \$599<sup>EE</sup> EA ★

#### OPTIONS

<b>1293784</b>	Wheeled Stand	\$99 <sup>EE</sup> EA ★
<b>1240597</b>	Extra Loud Horn	\$63 <sup>EE</sup> EA ★
<b>1142266</b>	Carry Bag	\$74 <sup>EE</sup> EA ★
<b>1201789</b>	Replacement Remote	\$53 <sup>EE</sup> EA ★
<b>1167443</b>	Replacement Power Cord/Adaptor	\$24 <sup>EE</sup> EA ★
<b>1171570</b>	Replacement Battery	\$39 <sup>EE</sup> EA ★

8'

4'

## Westview High School HOME OF THE TITANS

**HOME** 15:18 **GUEST**

04 4 03

**BONUS** **POSS** **POSS** **BONUS**

Color options: **Black** **Green** **Maroon**  
**Navy** **Purple** **Red** **Royal**



### 8' X 4' INDOOR SCOREBOARD

- 15" super-bright, 100,000 hour rated LED numerals (750' viewing distance)
- Scores 0-199 and clock will also count down from 99:59
- 1/10th second timing feature during final minute
- Galvanized steel cabinet with powder-coated finish
- Includes horn and 150 feet of control cable (if operated by cable)
- Weight: 180 lbs.

#### 5 Year Limited Warranty

MSBBB4	Basic (as shown)	\$3,099 <sup>22</sup> EA	★	
MSBBB4DB	Double Bonus	\$3,199 <sup>22</sup> EA	★	

#### OPTIONS

MSBREMI	Wireless Remote Control*	\$1,199 <sup>22</sup> EA	★
I376992	Handi-Score	\$799 <sup>22</sup> EA	
MSBCBL	Control Cable	\$0.83 FT	★
MSBPP4	Battery for Wireless Remote	\$124 <sup>22</sup> EA	★
MSBNET5	Protective Net (9' x 4.5')	\$479 <sup>22</sup> EA	★
MSBSPN2	Sponsor Panel (21" X 8")	\$449 <sup>22</sup> EA	★
MSBBB4L	Logo Above Home/Guest	\$229 <sup>22</sup> EA	
I366507	Receiver for 2nd Scoreboard**	\$599 <sup>22</sup> EA	

\*Must be factory installed  
\*\*Two scoreboards only work together on one controller with wireless option



8'

5'

**HOME** 15:18 **GUEST**

42 2 23

**BONUS** **PERIOD** **BONUS**

**FOULS** **PLAYER** **FOULS**

Color options: **Black** **Green** **Maroon**  
**Navy** **Purple** **Red** **Royal**

### 8' X 5' INDOOR SCOREBOARD

- 15" super-bright, 100,000 hour rated LED numerals (750' viewing distance)
- Scores 0-199 and clock will also count down from 99:59
- 1/10th second timing feature during final minute
- Interchangeable panels for volleyball and wrestling
- Galvanized steel cabinet with powder-coated finish
- Includes horn and 150' of control cable (if operated by cable)
- Weight: 260 lbs.

#### 5 Year Limited Warranty

MSBBBI	Basic (As Shown)	\$3,499 <sup>22</sup> EA	★	
MSBBBIDB	Double Bonus	\$3,699 <sup>22</sup> EA	★	
MSBBBITO	Timeouts Left	\$3,699 <sup>22</sup> EA	★	
MSBBBIDT	Double Bonus/Timeouts Left	\$3,799 <sup>22</sup> EA	★	

#### OPTIONS

MSBREMI	Wireless Remote Control*	\$1,199 <sup>22</sup> EA	★
MSBCBL	Control Cable	\$0.83 FT	★
MSBPP4	Battery for Wireless Remote	\$124 <sup>22</sup> EA	★
MSBNET7	Protective Net (9' x 8')	\$519 <sup>22</sup> EA	★
MSBSPN2	Sponsor Panel (21" X 8")	\$449 <sup>22</sup> EA	★
MSBBB4L	Artwork Left/Right of Fouls	\$229 <sup>22</sup> EA	
I366507	Receiver for 2nd Scoreboard**	\$599 <sup>22</sup> EA	

\*Must be factory installed  
\*\*Two scoreboards only work together on one controller with wireless option



8'

7'

**HOME** 11:46 **GUEST**

99 4 85

**BONUS** **PERIOD** **BONUS**

**FOULS** **PLAYER** **FOULS**

**WON** **GAME** **WON**

Color options: **Black** **Green** **Maroon**  
**Navy** **Purple** **Red** **Royal**

### 8' X 7' INDOOR SCOREBOARD

- 15" super-bright, 100,000 hour rated LED numerals (750' viewing distance)
- Scores 0-199 and clock will also count down from 99:59
- 1/10th second timing feature during final minute
- Interchangeable panels for volleyball and wrestling
- Galvanized steel cabinet with powder-coated finish
- Includes horn and 150' of control cable (if operated by cable)
- Weight: 260 lbs.

#### 5 Year Limited Warranty

MCSBI86M	Basic (as shown)	\$4,799 <sup>22</sup> EA	★	
MCSBI86MDB	Double Bonus	\$4,899 <sup>22</sup> EA	★	
MCSBI86MTO	Timeouts Left	\$4,899 <sup>22</sup> EA	★	
MCSBI86MDT	Dbl Bonus/Time Out	\$5,099 <sup>22</sup> EA	★	

#### OPTIONS

MSBREMI	Wireless Remote Control*	\$1,199 <sup>22</sup> EA	★
MSBCBL	Control Cable	\$0.83 FT	★
MSBPP4	Battery for Wireless Remote	\$124 <sup>22</sup> EA	★
MSBNET7	Protective Net (9' x 8')	\$519 <sup>22</sup> EA	★
MSBSPN2	Sponsor Panel (21" X 8")	\$449 <sup>22</sup> EA	★
I366507	Receiver for 2nd Scoreboard**	\$599 <sup>22</sup> EA	

\*Must be factory installed  
\*\*Two scoreboards only work together on one controller with wireless option



## ADDITIONAL SCOREBOARD OPTIONS

Call for details

### Electronic Team Names



### Sponsor Truss Panels



### Basketball Backboard Lights





### ULTIMATE SCOREBOARD

- 12" and 8" super-bright, 100,000 hour rated LED numerals (500' viewing distance)
- Scores 0-99 and clock will count down from 99:59
- Galvanized steel cabinet with powder-coated finish
- Includes horn, bonus and possession indicators
- Wireless remote standard
- Weight: 100 lbs.

#### 5 Year Limited Warranty

MSBULTB	Black	\$2,699 <sup>22</sup>	EA ★	
MSBULTC	Specify Color	\$2,899 <sup>22</sup>	EA ★	
MSBNET4	Protective Net (7' x 3.5')	\$419 <sup>22</sup>	EA ★	

#### Color options:



### Unleash Your Scoring Capabilities!

#### HANDI-SCORE PORTABLE CONTROLLER

- Eliminates the need for additional scorekeepers
- Allows umpires and referees to control the scoreboard from the field
- Slim 1.25" easy-to-hold profile makes one-handed operation simple
- Light and portable with 1,000' + wireless range
- Recharging cradle (included) keeps HandiScore ready for your next game
- Lithium-ion rechargeable battery included
- Back-up power via mini-USB port (USB cable included)
- 8+ hours of operation from each charge
- Operate multiple scoreboards simultaneously
- 2.4 GHz, frequency hopping spread spectrum technology insures strong wireless signal

#### 5 Year Limited Warranty

1376992	Basketball/Volleyball/Wrestling	\$799 <sup>22</sup>	EA ★
1376993	Baseball/Softball	\$799 <sup>22</sup>	EA ★
1376994	Soccer/Lacrosse/Multi-Sport	\$799 <sup>22</sup>	EA ★
1376995	Football	\$799 <sup>22</sup>	EA ★

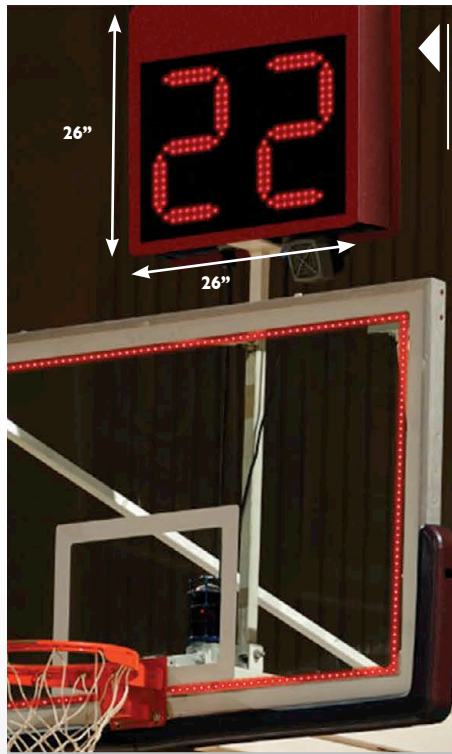

#### PERMANENT MOUNT BASKETBALL SHOT CLOCKS

- 15" super-bright, 100,000 hour rated LED numerals (750' viewing distance)
- Includes 2 Shot Clocks and (2) 100' control cables
- Program up to 99-second count down
- Built-in horns
- Must operate off an existing MacGregor basketball scoreboard controller
- Weight - 35 lbs. each
- 5 Year Limited Warranty



#### 8' x 3' INDOOR SCOREBOARD

- 15" super-bright, 100,000 hour rated LED numerals (750' viewing distance)
- Scores 0-199; clock counts down from 99:59
- 1/10 second timing feature during final minute
- Galvanized steel cabinet with powder-coated finish
- Includes horn, bonus & possession indicators and 150' of control cable (if operated by cable)
- Weight - 135 lbs.
- 5 Year Limited Warranty

#### OPTIONS

MSBREMI	Wireless Remote Control*	\$1,199 <sup>22</sup>	EA ★
1376992	Handi-Score	\$799 <sup>22</sup>	EA
MSBCBL	Control Cable	\$0.83	FT ★
MSBPP4	Battery for Wireless Remote	\$124 <sup>22</sup>	EA ★
MSBNET5	Protective Net (9' x 4.5')	\$479 <sup>22</sup>	EA ★
MSBSPN2	Sponsor Panel (21" X 8')	\$449 <sup>22</sup>	EA ★
1366507	Receiver for 2nd Scoreboard**	\$599 <sup>22</sup>	EA



MSBBB3	Basic Scoreboard***	\$2,499 <sup>22</sup>	EA ★	
MSBBB3DB	Double Bonus	\$2,699 <sup>22</sup>	EA ★	
MSBPSC	Basketball Shot Clocks	\$2,099 <sup>22</sup>	SET ★	

#### Color options:



\*Must be factory installed

\*\*Two scoreboards only work together on one controller with wireless option

\*\*\*Electronic team name available as additional options

Optional Truss shown. Call for pricing



### 20' X 8' FOOTBALL SCOREBOARD

- 26" super-bright, 100,000 hour rated LED numerals with digit protective shields (1000' viewing distance)
- Galvanized steel cabinet with powder-coated finish
- Includes operator keyboard with AC wall transformer (customer must order cable length separately), junction box cover, and mounting rails
- Complete operation, installation and service manual
- Logo shown not included in basic price
- Weight: 1250 lbs.

**5 Year Limited Warranty**

MSBFB4	Basic	\$8,899 <sup>22</sup> EA	★
MSBFB4TO	With Timeouts Left	\$9,399 <sup>22</sup> EA	★



**Color options:**

- Black
- Green
- Maroon
- Navy
- Purple
- Red
- Royal

**OPTIONS**

MSBREM4	Wireless Remote Control *	\$1,149 <sup>22</sup> EA	★	MSBSPN5	Sponsor Panel (20' X 31")	\$1,099 <sup>22</sup> EA	★	
MSBCBL	Control Cable	\$0.83	FT	★	MSBFB4L	Custom Logo on Scoreboard	\$499 <sup>22</sup> EA	★
MSBPPP4	Battery for Wireless Remote	\$124 <sup>22</sup> EA	★	MSBFB4CKB	Baseball Conversion Kit	\$459 <sup>22</sup> EA	★	
MSBHORN	Loud Outdoor Horn	\$599 <sup>22</sup> EA	★	MSBFB4CKS	Soccer Conversion Kit	\$459 <sup>22</sup> EA	★	

\*Must be factory installed

16'

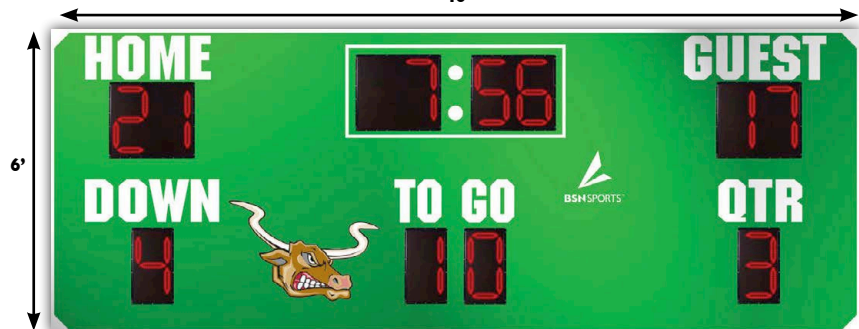

**OPTIONS**

MSBREM4	Wireless Remote Control *	\$1,149 <sup>22</sup> EA	★	
I376995	Handi-Score	\$799 <sup>22</sup> EA	★	
MSBCBL	Control Cable	\$0.83	FT	★
MSBPPP4	Battery for Wireless Remote	\$124 <sup>22</sup> EA	★	
MSBHORN	Loud Outdoor Horn	\$599 <sup>22</sup> EA	★	
MSBBSPN4	Sponsor Panel (21" x 16')	\$749 <sup>22</sup> EA	★	
MSBCKBS3	Baseball Conversion Kit	\$429 <sup>22</sup> EA	★	
MSBCKSC3	Soccer Conversion Kit	\$429 <sup>22</sup> EA	★	

\*Must be factory installed



**Color options:**

- Black
- Green
- Maroon
- Navy
- Purple
- Red
- Royal

### 16' X 6' FOOTBALL SCOREBOARD

- 15" Super-bright, 100,000 hour rated LED numerals with digit protective shields (750' viewing distance)
- Optional conversion kits for baseball and soccer (see options)
- Galvanized steel cabinet with powder coated finish

- Includes operator keyboard with AC wall transformer (customer must order cable length separately), junction box cover and mounting rails
- Complete installation, operation and service manual
- Weight - 275 lbs.

**5 Year Limited Warranty**

MSBFB3	As Shown	\$7,299 <sup>22</sup> EA	★
--------	----------	--------------------------	---

### 8' X 5' FOOTBALL SCOREBOARD

- 15" super-bright, 100,000 hour rated LED numerals with digit protective shields (750' viewing distance)
- Optional conversion kits for baseball and soccer (see options)
- Galvanized steel cabinet with powder-coated finish
- Includes operator keyboard with AC wall transformer (customer must order cable length separately), junction box cover and mounting rails
- Complete operation, installation and service manual
- Weight: 275 lbs.

**5 Year Limited Warranty**

MSBFB2	As Shown	\$4,999 <sup>22</sup> EA	★
--------	----------	--------------------------	---

**OPTIONS**

MSBREM4	Wireless Remote Control *	\$1,149 <sup>22</sup> EA	★	
I376995	Handi-Score	\$799 <sup>22</sup> EA	★	
MSBCBL	Control Cable	\$0.83	FT	★
MSBPPP4	Battery for Wireless Remote	\$124 <sup>22</sup> EA	★	
MSBHORN	Loud Outdoor Horn	\$599 <sup>22</sup> EA	★	
MSBSPN2	Sponsor Panel (21" X 8')	\$449 <sup>22</sup> EA	★	
MSBCKBS	Baseball Conversion Kit	\$299 <sup>22</sup> EA	★	
MSBCKSC	Soccer Conversion Kit	\$299 <sup>22</sup> EA	★	

\*Must be factory installed



**Color options:**

- Black
- Green
- Maroon
- Navy
- Purple
- Red
- Royal



**FOOTBALL DELAY-OF-GAME CLOCK**

- 26" super bright 100,000-hour rated LED displays (1000' viewing distance)
- Available as an independent system or for attachment to an existing MacGregor football scoreboard
- Optional wheel stand available
- Galvanized steel cabinet with powder-coated finish
- Weight - 85 lbs. (each clock)
- (Wireless remote required for Hand Held Controller option)

**5 Year Limited Warranty**

MSBFB6	Independent System	\$4,199 <sup>22</sup>	PR ★	SeH
MSBFB6S	Independent System w/Stand	\$4,799 <sup>22</sup>	PR ★	SeH
MSBFB7	Existing Scoreboard	\$3,599 <sup>22</sup>	PR ★	SeH
MSBFB7S	Existing Scoreboard w/ Stands	\$4,199 <sup>22</sup>	PR ★	SeH

**OPTIONS**

MSBCBL	Control Cable	\$0.83	FT ★
MSBPP4	Battery for Wireless Remote	\$124 <sup>22</sup>	EA ★
MSBREM8	Wireless Remote - Independent System	\$1,749 <sup>22</sup>	EA ★
MSBREM9	Wireless Remote - Existing System	\$1,199 <sup>22</sup>	EA ★
I376996	Hand Held Controller	\$659 <sup>22</sup>	EA ★



- Color options:**
- Black
  - Green
  - Maroon
  - Navy
  - Purple
  - Red
  - Royal

**FOOTBALL SEGMENT TIMER**

- 13" super-bright, 100,000 hour rated LED numerals (300' viewing distance)
- Interchangeable colon and white divider line allows user to change the configuration of the timer so the period can go to 9 or 99
- Count down from 9:59 or 99:59
- Built-in horn
- Galvanized steel cabinet with powder-coated finish
- Includes controller with 10' control cable and 25' control cable extension
- Weight: 45 lbs.

**2 Year Limited Warranty**

MSBFB5	Segment Timer	\$1,999 <sup>22</sup>	EA ★
--------	---------------	-----------------------	------

**OPTIONS**

MSBFB5ST	Portable Stand	\$209 <sup>22</sup>	EA ★
MSBREM3	Wireless Remote Control*	\$899 <sup>22</sup>	EA ★
MSBDPS2	Dual Power System*	\$259 <sup>22</sup>	EA ★
MSBBAT3	External Battery	\$199 <sup>22</sup>	EA ★

\*Must be factory installed



**PRO-DOWN**

**SEGMENT TIMER w/WIRELESS REMOTE**

- 8" and 13" super-bright, LED numerals (300' viewing distance)
- Program your practice schedule and workout drills
- All steel cabinet with built in handle, weather protector, fence attachment and storage pouch for remote programmer
- AC or DC with built-in, 8 hour rechargeable battery
- 140 decibel horn sounds after each segment, 3 short beeps after each rest period
- Program up to 99 segments from 1 second to 99 minutes. The last minute always counts down in seconds
- Wireless remote remembers last entry and has a range of 65 feet
- Weight: 26 lbs.

I239645	Segment Timer	\$1,499 <sup>22</sup>	EA ★
I239652	Replacement Wireless Remote	\$79 <sup>22</sup>	EA ★
I171570	Replacement Battery	\$39 <sup>22</sup>	EA ★



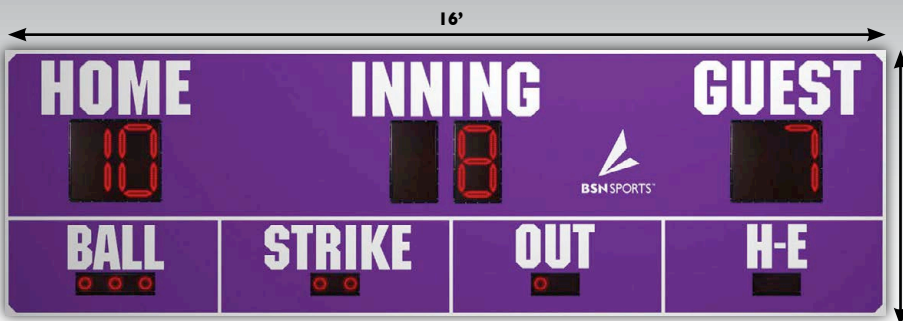

**16' X 5' BASEBALL SCOREBOARD**

- 20" super-bright, 100,000 hour rated LED numerals with digit protective shields (750' viewing distance)
- Galvanized steel cabinet with powder-coated finish

- Scores & innings up to 99
- Weight: 650 lbs.
- 5 Year Limited Warranty**

MSBBSI As Shown \$4,199<sup>22</sup> EA ★ **Set H**

**OPTIONS**

MSBREM2	Wireless Remote Control*	\$899 <sup>22</sup> EA ★
I376993	Handi-Score	\$799 <sup>22</sup> EA ★
MSBCBL	Control Cable	\$0.83 FT ★
MSBBSPN4	Sponsor Panel (21" x 16")	\$749 <sup>22</sup> EA ★
MSBBSIL	Custom Logo Left/Right of Inning	\$599 <sup>22</sup> EA ★

\*Must be factory installed



**Color options:**

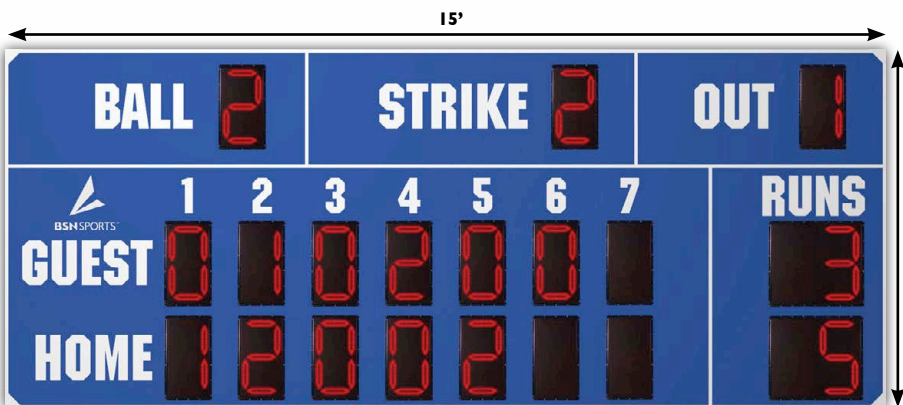

**BSN 15' X 6'6" BASEBALL SCOREBOARD**

- 15" super-bright, 100,000 hour rated LED numerals with digit protective shields (750' viewing distance)
- Galvanized steel cabinet with powder-coated finish
- Displays home & guest scores by inning up to 7 innings

- Operates by wireless remote or direct cable (see OPTIONS)
- Weight 650 lbs.
- 5 Year Limited Warranty**

MSBBSII As Shown \$7,699<sup>22</sup> EA ★ **Set H**

**OPTIONS**

MSBREM1	Wireless Remote Control*	\$1,199 <sup>22</sup> EA ★
MSBCBL	Control Cable	\$0.83 FT ★
MSBPP4	Battery for Wireless Remote	\$124 <sup>22</sup> EA ★
MSBSPN6	Sponsor Panel (15' X 21")	\$739 <sup>22</sup> EA ★

\*Must be factory installed



**Color options:**

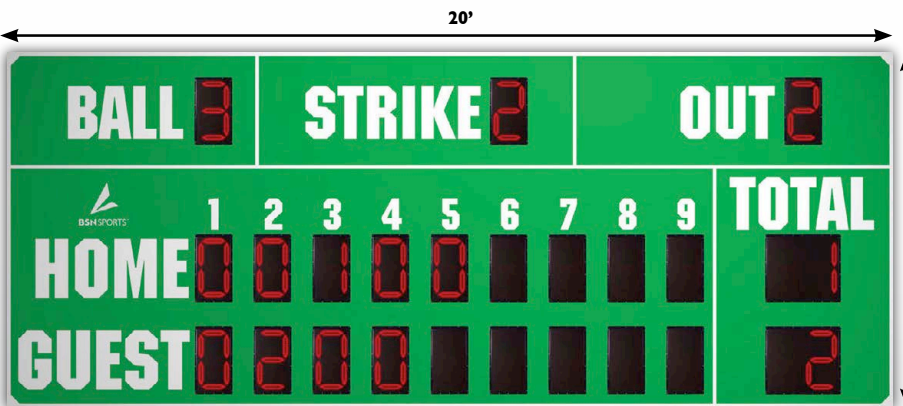

**20' X 8' BASEBALL SCOREBOARD**

- 15" super-bright, 100,000 hour rated LED numerals with digit protective shields (750' viewing distance)
- Galvanized steel cabinet with powder-coated finish
- Displays home and guest scores by inning up to 9 innings
- 10-inning scoreboard is also available

- Weight: 1250 lbs.
- 5 Year Limited Warranty**

MSBBS9 9-Inning (As Shown) \$8,999<sup>22</sup> EA ★ **Set H**  
 MSBBS3 10-Inning \$12,999<sup>22</sup> EA ★ **Set H**

**OPTIONS**

MSBREM1	Wireless Remote Control*	\$1,199 <sup>22</sup> EA ★
MSBCBL	Control Cable	\$0.83 FT ★
MSBPP4	Battery for Wireless Remote	\$124 <sup>22</sup> EA ★
MSBSPN5	Sponsor Panel (20' X 31")	\$1,099 <sup>22</sup> EA ★

\*Must be factory installed



**Color options:**



## 60" x 27" BASEBALL PITCH COUNTER

- 15" Super-bright displays, 100,000 hour rated LED numerals (750' viewing distance)
- HOME and GUEST pitch count to 99
- Add on model works with existing MacGregor Baseball/Softball scoreboards.
- Stand alone model includes controller
- Galvanized steel cabinet with power-coated finish
- Weight: 120 lbs

5 Year Limited Warranty

Color options:



## 8' x 4' BASEBALL SCOREBOARD

- 15" red, super-bright, 100,000 hour rated LED numerals with digit protective shields (750' viewing distance)
- Galvanized steel cabinet with powder-coated finish
- Scores to 99, innings to 9
- Operated by wireless remote or direct cable (see OPTIONS)
- Weight - 275 lbs.

5 Year Limited Warranty

MSBBS5	Scoreboard Only	\$2,999 <sup>22</sup> EA ★	
MSBPCB	Add-on Pitch Counter	\$1,799 <sup>22</sup> EA ★	
MSBPCA	Stand Alone Pitch Counter	\$2,199 <sup>22</sup> EA ★	



### OPTIONS FOR MSBBS5 & MSBBSI3

MSBREM2	Wireless Remote (Board Only)*	\$899 <sup>22</sup> EA ★
MSBREMI	Wireless Remote (Board & Pitch Count)*	\$1,199 <sup>22</sup> EA ★
I376993	Handi-Score	\$799 <sup>22</sup> EA
MSBCBL	Control Cable	\$0.83 FT ★
MSBSPNI	Sponsor Panel (21" X 8')	\$449 <sup>22</sup> EA ★

\*Must be factory installed

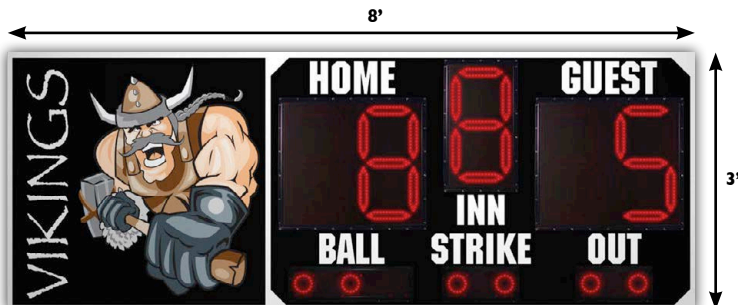

MSBBSI3 As Shown \$3,199<sup>22</sup> EA ★



## 8' X 5' BASEBALL SCOREBOARD

- 15" super-bright, 100,000 hour rated LED numerals with digit protective shields (750' viewing distance)
- Galvanized steel cabinet with powder-coated finish
- Scores to 99, innings to 9
- Clock counts down from 99 minutes, final minute in seconds
- MCSBBS86 clock can be used as a pitch count
- Weight: 275 lbs.

5 Year Limited Warranty

MCSBBS86	As Shown	\$3,999 <sup>22</sup> EA ★	
----------	----------	----------------------------	--

Color options:



### OPTIONS

MSBREMI	Wireless Remote Control*	\$1,199 <sup>22</sup> EA ★	MSBHORN	Loud Outdoor Horn	\$599 <sup>22</sup> EA ★
I376993	Handi-Score	\$799 <sup>22</sup> EA	MSBSPNI	Sponsor Panel (21" X 8')	\$449 <sup>22</sup> EA ★
MSBCBL	Control Cable	\$0.83 FT ★	MSBKISC	Soccer Conversion Kit	\$249 <sup>22</sup> EA ★
MSBPP4	Battery for Wireless Remote	\$124 <sup>22</sup> EA ★	MSBKIFB	Football Conversion Kit	\$249 <sup>22</sup> EA ★

\*Must be factory installed





### 8' x 4' Soccer Outdoor Scoreboard

- 15" red, super-bright, 100,000 hour rated LED numerals with digit protective shields (750' viewing distance)
- Galvanized steel cabinet with powder-coated finish
- Scores to 99, periods to 9
- Clock counts down from 99:59 with 1/10th seconds during final minute
- Operated by wireless remote or direct cable (see OPTIONS)
- Weight - 180 lbs.

5 Year Limited Warranty

MSBMT2 As Shown \$2,999<sup>EA</sup> ★ **S&H**

OPTIONS		
MSBREMI	Wireless Remote Control*	\$1,199 <sup>EA</sup> ★
I376994	Handi-Score	\$799 <sup>EA</sup> ★
MSBCBL	Control Cable	\$0.83 FT ★
MSBPP4	Battery for Wireless Remote	\$124 <sup>EA</sup> ★
MSBHORN	Loud Outdoor Horn	\$599 <sup>EA</sup> ★
MSBSPNI	Sponsor Panel (21" X 8')	\$449 <sup>EA</sup> ★

\*Must be factory installed

Color options:

- Black
- Green
- Maroon
- Navy
- Purple
- Red
- Royal

### MULTI-SPORT MANUAL OUTDOOR SCOREBOARD

- 9" Yellow fluorescent numbers (300' viewing distance)
- Scores to 99, Period / Inning to 9
- "Moveable window" numbers slide in and out of view
- Economical and easy to use, requires no electricity
- Leg assembly, fence mount hardware and sponsor panel lettering sold separately
- Weight: 20 lbs.

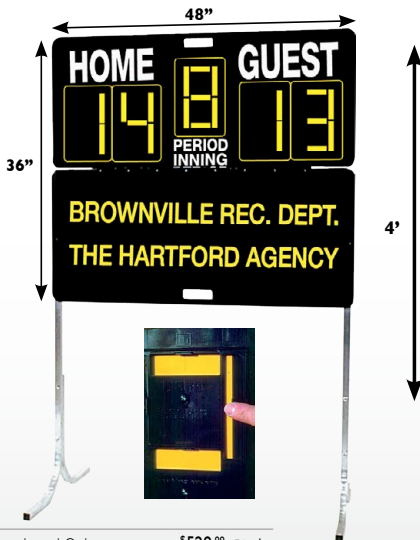

MSBBS4 Scoreboard Only \$529<sup>EA</sup> ★

OPTIONS		
MSBBS4LA	Leg Assembly	\$189 <sup>EA</sup> ★
MSBBS4FW	Fence/Wall Mount	\$29 <sup>EA</sup> ★
MSBBS4LT	Sponsor Panel Lettering (1 Color)	\$199 <sup>EA</sup> ★



### 8' x 4' HANGING NUMBERS BASEBALL SCOREBOARD

- 9" plastic numbers (300' viewing distance)
- Galvanized steel cabinet with powder-coated finish
- Scores to 9 for each inning, 99 for total
- Comes complete with (1) set of hanging numbers and hooks
- Designed to mount on two 4" X 4" posts (not included)
- Weight: 100 lbs.

MSBBS8 Scoreboard Without Lettering \$849<sup>EA</sup> ★ **S&H**  
 MSBLTR3 Sponsor Panel Lettering (1 color) \$209<sup>EA</sup> ★  
 MCSBNU84 Extra Set Hanging Numbers \$219<sup>SET</sup> ★

Color options:

- Black
- Green
- Navy
- Purple
- Red
- Royal
- Maroon



### BASEBALL PORTA-SCORE

- Constructed of white enamel steel and uses magnetic numbers
- Easily hangs on fence or can sit on a table, roof of dugout
- Includes (50) 4" x 5" magnetic numbers, (2) 10" magnets for home and visitors and a canvas storage bag which holds numbers and scoreboard panel
- Board folds in half for easy storage
- Weight: 25 lbs.
- 70" W x 18" H

1270337 Complete Unit As Shown \$329<sup>EA</sup> EA  
 1245950 Numbers Only \$149<sup>SET</sup> SET





## 8' x 5' LACROSSE SCOREBOARD

- 15" red, super-bright 100,000 rated LED numerals with LED digit protective shields (750' viewing distance)
- Scores up to 99, periods up to 9
- Operated by wireless remote or direct cable but customer must order cable length separately (see OPTIONS)
- Includes standard keyboard controller with Lacrosse keypad insert
- Clock counts down from 99 minutes max, last minute in seconds
- Galvanized steel cabinet with powder coat finish

### 5 Year Limited Warranty

MCSBSC86

Scoreboard Only

 \$3,899<sup>22</sup> EA ★ 

### OPTIONS

MSBREMI	Wireless Remote Control*	\$1,199 <sup>22</sup> EA ★
I376994	Handi-Score	\$799 <sup>22</sup> EA ★
MSBCBL	Control Cable	\$0.83 FT ★
MSBHORN	Loud Outdoor Horn	\$599 <sup>22</sup> EA ★
MSBPP4	Battery for Wireless Remote	\$124 <sup>22</sup> EA ★
MSBSPNI	Sponsor Panel (21" X 8')	\$449 <sup>22</sup> EA ★



Color options:



\*Must be factory installed

## NEW!

### LACROSSE SHOT CLOCK

- 15" super bright 100,000-hour rated LED displays (up to 750' viewing distance)
- Galvanized steel cabinet with powder-coated finish
- Built in horn with two preset times
- Includes two shot clocks, wireless LCD controller and wireless hand held ref switch
- AC powered with optional power pack available
- Portable wheel stands available as optional purchase
- Weight - 40 lbs. (each clock)

### 5 Year Limited Warranty

I388068	Clocks, Controller & Ref Switch	\$4,999 <sup>22</sup> PR ★
I388073	Optional Stands - Pair	\$599 <sup>22</sup> PR ★
I388078	Optional Port Power Pack - Pair	\$1,699 <sup>22</sup> PR ★



Color options:



### PORTABLE MULTI-SPORT SCOREBOARD

- 9" and 6" super-bright, 100,000 hour rated LED numerals (750' viewing distance)
- Galvanized steel cabinet with powder-coated finish
- Ships standard as basketball board but easily converts to other sports using magnetic conversion kits (included)
- Scores baseball, softball, football, soccer, field hockey, lacrosse, volleyball, basketball, wrestling & track
- 1/10th and 1/100th second timing standard
- Comes with controller, 25' of control cable, built in rechargeable 12v battery and charger
- Does not come with sponsor panel, must be purchased with initial order
- 12 hour charge will provide 6 hours of run time
- Weight: 95 lbs.

MSBMT1

 \$3,299<sup>22</sup> EA ★ 

### OPTIONS

MSBREM3	Wireless Remote Control*	\$899 <sup>22</sup> EA ★
MSBBAT3	External Battery	\$199 <sup>22</sup> EA ★
MSBLTR7	Sponsor Panel and Lettering	\$359 <sup>22</sup> EA ★

\*Must be factory installed

Color options:

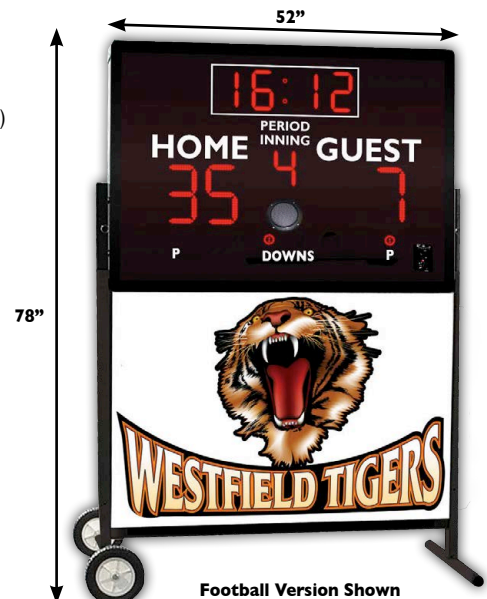

Football Version Shown



**PORTABLE MANUAL SCOREKEEPER**

- 6" score digits
- 2.5" Period/Games digit up to 5
- Scores game up to 99 for each side
- No assembly required
- Lays flat for storage



**I196177** 11"H x 23"W \$49<sup>99</sup> EA ★

**TABLETOP FLIP SCOREBOARD**

- Flip style scoring with 5.5" heavy plastic board numerals
- Scores 0 through 99
- Suction cups stick to table
- Weight: 5 lbs.



**MSTTSCOR** 13"H x 18"W \$84<sup>99</sup> SET ★

**REPLACEMENT NUMBERS**

- 100 black numbers (0-99)
- 7.25"H x 6.75"W
- 3.125" spacing between holes
- For use with MSTTSCOR

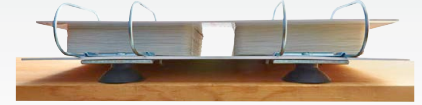

**MSTTSNUM** 0 - 99 \$32<sup>99</sup> SET ★



**MANUAL TABLETOP DOUBLE SIDED SCOREBOARD**

- 6" numbers for scoring
- 2.5" numbers to score games (0-5 for each side)
- Scores up to 30 for each team
- Double-sided, see the score from front and back
- Folds up for easy transport and storage

**DOUBLE SIDED**



**MSMLTSCR** 7"H x 15"W \$55<sup>99</sup> EA ★



**PORTABLE FENCE MOUNTED SCOREBOARD**

- 7" numbers connect using hook and loop
- Made of heavy duty 14 oz. vinyl
- Includes dry erase panels for team names
- 3 pockets attach to the bottom to hold numbers
- Includes 19 numbers for scoring and 9 numbers for innings / periods
- Rolls up for easy storage in the included bag



**I240009** 30"H x 48"W \$82<sup>99</sup> EA ★  
**I378630** Replacement Numbers - White on Red \$24<sup>99</sup> SET ★  
**I378631** Replacement Numbers - Red on White \$24<sup>99</sup> SET ★



**MANUAL SCOREKEEPER WITH ADJUSTABLE STAND**

- 7" numbers printed on vinyl
- Scores up to 99 for each team
- Two erasable team panels
- PVC stand measures 38"H with a 15" x 15" base
- Converts from floor model to 12"H table top unit

**I162448** \$51<sup>99</sup> EA ★



**BUDGET POSSESSION INDICATOR**

- Rigid plastic triangular design with arrow
- Simply turn to indicate possession
- Weight: 1 lb.

**I248395** \$22<sup>99</sup> EA ★



**LED BASKETBALL POSSESSION INDICATOR**

- Bright, 10,000 hour LED lights
- Toggle switch operation
- Includes 15' cord
- Weight: 4 lbs.

**I162639** 5"H x 20"W x 2"D \$139<sup>99</sup> EA ★



### DELUXE GAME CLOCK

- Large, easy to read 4 3/4" face
- Start/stop/reset functions
- Includes (1) AA battery

**20014031**

 \$164<sup>22</sup> EA

**MacGregor**

### COUNT UP/DOWN CLOCK

- 4" LED numbers
- Timer counts up or down to 99:59
- 120 a/c power with 8 hour rechargeable battery
- Perfect device designed for any timed activities in your P.E. or Athletic program
- Built in control on top of timer with horn

**1126631**

6"H x 13"W x 4"D

 \$279<sup>22</sup> EA ★

### Robic BIG GAME TIMER

- Track two events at the same time
- Shows time remaining as a value and percentage of total
- Easy to operate rotary switch sets countdown time
- Local time of day and calendar
- AAA battery included

**1369566**

M803

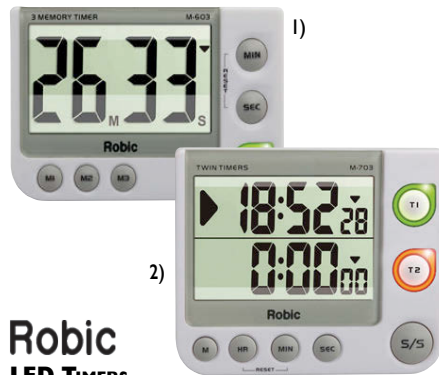
 \$36<sup>22</sup> EA

### Robic LED TIMERS

- Flashing LED indicators confirm countdown status - active (green) or stopped (red)
- Use for timing any sport or recreational activity
- Count up or down functions
- Three alarm options - silent, regular or extra loud
- Single up to 99:59, Twin up to 99:59:59
- (2) AAA alkaline batteries included

**1271355**

M603 - 3 Memory Timer

 \$20<sup>22</sup> EA

**1369565**

M703 - Twin Timer

 \$24<sup>22</sup> EA

**MacGregor**

### HANDHELD GAME TIMER

- Counts down from 99 minutes
- Features 1/100th second LED display, unlimited start-stop, audible end signal
- Includes clip with magnetic attachment
- (1) AAA battery included

**MSSTP500**

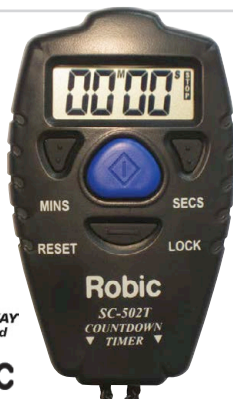
 \$19<sup>22</sup> EA ★

**BREAK AWAY  
Safety Lanyard**

### Robic COUNTDOWN TIMER

- Countdown in seconds (up to 99 min. & 59 sec.)
- Can be used silently or with audible beep
- Onetouch reset to preset time
- Start & restart for time-outs
- Lock Function protects current setting
- Break-away Safety Lanyard
- Extralarge display; uses LR44 battery

**MSSTP502**

SC-502T

 \$24<sup>22</sup> EA

### Robic COUNTDOWN TIMER PRISM PACK

- Counts down in seconds or minutes
- Can be used silently or with audible beep confirmation
- Resets to preset time
- Stop and re-start for time outs
- Lock function to protect current setting
- Break-away safety lanyard
- Includes LR44 battery

**1271362**

SC-512

 \$89<sup>22</sup> PACK OF 6

### Robic COUNT-UP & COUNTDOWN TIMER

- Track two events at the same time
- Count up/down from zero
- Select time in seconds or minutes
- Automatically resets to preset time
- Stop & restart for time-outs
- LR44 battery included

**1369564**

SC-522

 \$19<sup>22</sup> EA

**BRACES**

Fits standard size shoe



**THE ONE ANKLE BRACE**

- Comfortable in cleats or shoes during competition
- Very light and low profile
- Seamless construction under the foot
- Features anti slip criss-crossing side straps, side pulling stirrups, and cushioned tongue
- Fits either foot
- Color - black only



**1375722** Specify Size **\$38<sup>22</sup>** EA

	MD	LG	XL	2XL	3XL
U.S. MEN	9-11	11-13	13-15	15-17	17-19
U.S. WOMEN	10-12	12-14	14-16	16-18	18-20



**PRO LEVEL HINGED KNEE BRACE**

- Extra large triaxial hinge properly tracks the knee joint producing near normal motion
- Removable patellar buttress can be cut to desired shape for proper tracking
- Extra long for maximum stability
- Lockout option for complete immobilization or limited range of motion (tool included)
- Fits either knee



**1362673** Specify Size **\$64<sup>22</sup>** EA

	7 in above center of knee	7 in below center of knee
MD	19-20 in (48-50 cm)	14-15 in (35-38 cm)
LG	21-22 in (53-55 cm)	15-16 in (38-40 cm)
XL	23-24 in (58-60 cm)	16-17 in (40-43 cm)
2XL	25-26 in (63-66 cm)	17-18 in (43-45 cm)

If measurements indicate different sizes, choose the larger size.



**T2 ACTIVE ANKLE**

- Durable quick fitting single strap system adjustable for both high and low top shoes
- Feather-light E.V.A. padding that hugs every contour of the ankle



**1050929** Specify Size **\$49<sup>22</sup>** EA

	S	MD	LG
U.S. MEN	5-8	9-12	12-16



**PRO LEVEL ATF2 ANKLE BRACE**

- Next generation inner straps help protect against inversion sprains
- Single layer of comfortable fabric over the ankle bones
- Rigid plastic stays act like tendons to reinforce both sides
- Permanently bonded antimicrobial barrier
- Fits either foot



**1362663** Black - Specify Size **\$29<sup>22</sup>** EA  
**1362658** White - Specify Size **\$29<sup>22</sup>** EA

	XS	SM	MD	LG	XL
U.S. MEN	6-7	7-9	9-11	11-13	13-15
U.S. WOMEN	7-8	8-10	10-12	12-14	14-16



**Hg80 HINGED KNEE BRACE**

- Triaxial hinge properly tracks the knee joint producing near normal motion
- Tibial containment system with secondary shell and patella buttress
- Upper and lower trapping system
- Highly comfortable Mueller exclusive HydraCinn fabric
- Permanently bonded antimicrobial barrier
- Free carry bag included!
- Fits either knee



**1362668** Specify Size **\$59<sup>22</sup>** EA

S	MD	LG	XL	2XL
12-114 in 30-35 cm	14-16 in 35-40 cm	16-18 in 40-45 cm	18-20 in 45-50 cm	20-22 in 50-55 cm

Measure the center of the knee



**ZK-7 KNEE BRACE**

- Strongest knee support for moderate to severe sprains
  - Provides 4-way ligament support with resin to support medial and lateral stability
  - Flow thru ventilation enhances cooling while in motion
- Size: **SML, MED, LRG, XLG, 2XL, 3XL, 4XL.**



**1377449** Specify Size **\$79<sup>22</sup>** EA



**A2-DX ANKLE BRACE**

- Strongest ankle support for moderate to severe ankle sprains
  - Anatomically (right & left) correct fit
  - Dual exterior molded support structure that prevents ankle from rolling inward and outward
  - Helps prevent high ankle sprains by reducing the separation of the two lower leg bones where they meet the ankle.
- Size: **S/R, M/R, L/R, XL/R, S/L, M/L, L/L, XL/L.**



**1377434** Specify Size & Left or Right Ankle **\$64<sup>22</sup>** EA



**ZK-3 KNEE BRACE**

- Provides moderate support for mild to moderate sprains
  - Two way support features unique resin stays to provide support to ligaments during activity
  - Allows for individualized fit with an open panel design
  - Equipped with adjustable fasteners to enhance comfort and allow variable compression levels
  - Flow thru ventilation enhances cooling while in motion
- Size: **SML, MED, LRG, XLG, 2XL, 3XL, 4XL.**



**1377442** Specify Size **\$64<sup>22</sup>** EA

ICE20 ICE THERAPY



**DOUBLE ANKLE**

- Compression wrap for ankle
- Comes with two 11" refillable ICE20 ice bags
- Durable mesh carry bag included

1385287 Fits L or R \$49<sup>22</sup> EA



**LARGE KNEE**

- Compression wrap for adult knee
- Comes with one 11" refillable ICE20 icebag
- Durable mesh carry bag included

1385289 Fits L or R \$49<sup>22</sup> EA



**DOUBLE KNEE**

- Compression wrap for knee
- Comes with two 11" refillable ICE20 ice bags
- Durable mesh carry bag included

1385290 Fits L or R \$79<sup>22</sup> EA



**BACK / HIP**

- Use for upper, mid, lower back
- Also used for hip, glutes, abs, pelvis
- Comes with one refillable 11" ICE20 icebag
- Durable mesh carry bag included

1385293 Fits L or R \$59<sup>22</sup> EA



**SINGLE SHOULDER**

- Pleated fabric design enables the ice bag to contour around the body
- Comes with one refillable 11" ICE20 icebag
- Durable mesh carry bag included

1385291 Fits L or R \$59<sup>22</sup> EA



**COMBO ARM**

- Compression wrap for shoulder to elbow
- Comes with two 11" and one 9" refillable ICE20 icebags
- Durable mesh carry bag included

1385294 Fits L or R \$119<sup>22</sup> EA



**TUF-SKIN® COLORLESS SPRAY**

- Helps secure all tapes, underwrap and elastics to the skin in order to reduce friction and help prevent blisters and chafing
- Same formula as original Tuf-Skin® without the color; will not stain skin or clothes
- FAA regulations, can not ship via overnight air or 2nd day air.



1078626 10 oz. Can \$19<sup>22</sup> EA



**REUSABLE HOT-KOLD GEL PAK**

- Packs are non-toxic, non-hazardous and FDA registered.
- Our "EASY PRESS" inner bag requires only finger pressure to activate.

1125894 4" x 6" \$29<sup>22</sup> DZN  
1099287 6" x 9" \$37<sup>22</sup> DZN



**INSTANT COLD PACKS**

- Simply shake granules to the bottom on package, squeeze until inner water bag breaks, shake package to mix contents, wrap package in soft cloth and apply to injured area
- Contains UREA for cold reaction; Once activated cold starts round 30B ends around 38B (lasts on average 30-35 minutes)
- Single use only

2215XXXX Small (4" X 6") \$19<sup>22</sup> PACK OF 16  
1125917 Large (6" X 9") \$27<sup>22</sup> PACK OF 16

**FLEX-I-WRAP**

- 4" wide plastic film on a roller makes wrapping a one-handed task
- Replaces elastic wraps at a fraction of the cost
- Provides compression while clear film allows inspection of injury
- Patented, built-in hand brake on roller makes tearing easy



MDFLXWRP 6 rolls w/ handle \$67<sup>22</sup> SET  
1082555 6 rolls only \$59<sup>22</sup> EA  
1082562 Handle only \$9<sup>22</sup> EA

**PRO-DOWN Ice BAGS**

- 1500 each, 10" x 18" bags per roll
- 1 mil thick clear bags
- Dispenser sold separately

1082579 Roll of 1,500 bags \$119<sup>22</sup> ROLL ★  
1089356 Dispenser only \$59<sup>22</sup> EA



**1.** **2.** **3.**

**Trainer Bags**

- Multiple layers of external storage makes space better organized and more accessible so you can quickly find what you need, when you need it
- Semi-rigid shell is encased in a combination of our new super durable and stylish Tuf-Tek material and our 1680 ballistic nylon
- Rigid supports in the main walls make this the most protective soft-sided kit in the Cramer line. It also helps the kit keep its shape and keep it looking new
- Rounded corner design gives a large, more aerodynamic and sleek look

<b>1. TUFF TEK SUPER</b>			
<b>1375586</b>	Equipped		\$259 <sup>22</sup> EA
<b>1375587</b>	Empty		\$209 <sup>22</sup> EA
<b>2. TUFF TEK PRO</b>			
<b>1375582</b>	Equipped		\$199 <sup>22</sup> EA
<b>1375583</b>	Empty		\$159 <sup>22</sup> EA
<b>3. TUFF TEK JUNIOR</b>			
<b>1375584</b>	Equipped		\$189 <sup>22</sup> EA
<b>1375585</b>	Empty		\$129 <sup>22</sup> EA

**ATHLETIC TRAINER REFILL KIT**

- Contains all the products you need to restock your trainer's kit in one easy purchase
- Contents: (1) 3" Elastic Wrap, (1) Tuf-Skin®, (1) PVP Pack, (1) Roll Athletic Tape, (1) Instant Cold Pack, (2) Latex Gloves, (1) Bulk Bandage Pack, (1) Skin Lube, (1) Sam™ Finger Splint, (1) Iso-Quin®, (1) Sports Injury Handbook, (1) Zip-Cut™, (1) Atomic Balm®, (1) Cinder Suds®, (1) Tape Underwrap, (1) Pocket Mirror, (1) Sterile Eye Wash, (10) Antibiotic Creams
- **Cannot be shipped by air**

**MDKITRFL** \$99<sup>22</sup> EA

### 25 PERSON FIRST AID KIT

- 9" x 6 5/16" x 2 3/8" Plastic Case with Waterproof Gasket and Wall Mount/Handle
- Kit Contents: (2) 1/2" x 5yd Adhesive Tape, (1) Instant Cold Pack, (10) Antiseptic Towelettes, (2 pair) Disposable Gloves, (10) 1/32 oz. First Aid Cream, (100) 1" x 3" Adhesive Strips, (1) 5" x 9" Combine Pad, (6) 3" x 3" Gauze Pads, (2) Oval Eye Pads, (1) Triangular Bandage, (1) 2" x 4yd Conforming Bandage, Scissors and Forceps

**1202106** OSHA Compliant \$29<sup>22</sup> EA



### COACH'S TEAM FIRST AID KIT

- Designed by athletic trainers to meet the first aid needs of competitive sports
- Contents: (2) Instant Cold Packs, (3) Knuckle Bandages, (5) Butterfly Bandages, (3) After Bite Sting Relief, (6) Tongue Depressors, (1) Tuf-Skin® Tape, (1) Tape Underwrap, (12) Antiseptic Towelettes, (10) 3" x 3" Gauze Pads, (3) Fingertip Bandages, (1) Scissors, (5) Antibiotic Cream, (1) Sports Injury Care Handbook, (1) Sam Finger Splint, (5) Acetaminophen, (10) 3/4" x 3" Bandages, (5) 2" x 4" Bandages, (6) Alcohol Prep Pads, (6) Latex Gloves, (1) 3" Elastic Wrap, (1) Skin Lube, (1) Triangle Bandage

**1089332** 14.5" x 10.25" x 14.25" \$89<sup>22</sup> EA

### 50 PERSON FIRST AID KIT

- 9" x 9" x 2 3/8" Plastic Case with Waterproof Gasket and Wall Mount/Handle
- Kit Contents: (2) 1/2" x 5yd Adhesive Tape, (2) Instant Cold Pack, (10) Antiseptic Towelettes, (2 pair) Disposable Gloves, (10) 1/32oz First Aid Cream, (8) Fingertip Bandages, (8) Knuckle Bandages, (2) Eye Wash Bottles, (100) 1" x 3" Adhesive Strips, (2) XL Adhesive Strips, (3) Insect Sting Relief, (1) 5" x 9" Combine Pad, (12) 2" x 2" Gauze Pads, (12) 3" x 3" Gauze Pads, (4) Oval Eye Pads, (2) Triangular Bandage, (2) 2" x 4yd. Conforming Bandage, (1) 4" x 2 yd. Conforming Bandage, (1) 3" Elastic Bandage, Scissors and Forceps

**1202113** OSHA Compliant \$52<sup>22</sup> EA



### PERSONAL FIRST AID KIT

- Plastic case with waterproof gasket
- Kit Contents: (10) 3/4" x 3" Adhesive Strips, (1) XL Adhesive Strip, (1) Fingertip Bandage, (1) Knuckle Bandage, (1) 2" Sterile Conforming Bandage, (2) 3" x 3" Gauze Pads, (2) Latex Gloves, (1) 1/2" x 5yd Adhesive Tape, (2) 1/32 oz. Triple Antibiotic, (2) 1/32 oz. First Aid Cream, (6) Antiseptic Towelette, (1) Instant Cold Pack, (1) Instant Sting Relief, (1) PAWS Antimicrobial Wipe

**1202090** 6.5" x 5" x 2" \$17<sup>22</sup> EA

**SPORT MEDICAL KIT**

- Soft padded cordura nylon bag with shoulder strap, heavy duty zipper, cold-pack holder with Velcro, waterproof bottom, and cell-phone compartment; 12" x 9" x 7", 7 lbs
- Kit includes: (1) 9" Reusable Ice Bag, (4) 6" x 8" Instant Cold Packs, (1) 6" x 30" Cold Pack Holder, (1) Blister Kit, (20) 1" x 3" Bandages, (6) 2" x 4.5" Large Bandages, (1) 3" x 5" Elastic Wrap, (1) Scissors, (10) Blood-Off Cloth Towelettes, (20) Latex-free Gloves, (1) 4 oz. Eye Wash, (2) Rolls 1.5"x15 yd. Athletic Tape, (1) Roll 2.75" x 30 yd. Pre-wrap, (20) Antimicrobial Skin Wipes, (1) Sport Wound Care Kit
- **Note: The Refill Pack includes all of the items above with the exception of the Reuseable Ice Bag, Cold Pack Holder and Scissors**
- Both the Medical Kit and Refill Pack cannot be shipped by air

<b>MDSPTMED</b>		
Equipped		\$229 <sup>22</sup> EA
Refill Pack		\$149 <sup>22</sup> KIT
<b>791IRFK</b>		



**BSN SPORTS PRE-WRAP**

- Pre-taping foam underwrap that protects athlete's skin from chafing and irritation
- Each roll is 2.75" x 30 yards long
- 48 rolls per case

**1378416** \$56<sup>22</sup> CASE



**BSN SPORTS ATHLETIC TAPE**

- 100% cotton backcloth, zinc oxide white trainer's tape
- High tensile strength with excellent tackiness
- 1 1/2" x 15 yard rolls

**1405995** 32 rolls per case \$62<sup>22</sup> CASE



**750 ATHLETIC TAPE**

- Zinc Oxide tape offers maximum tensile strength and comfortability
- Latex free adhesive
- Computer calibrated unwind for consistency and performance roll to roll
- Roll: 1.5" x 15 yd
- 32 rolls per case

**2190XXX** Case of 32 \$67<sup>22</sup> PACK 32 ROLLS



**Mueller M-WRAP**

- Pre-taping foam underwrap
  - Helps protect skin from tape chafing
  - Can be used to keep hair out of face, hold pads and socks in place and as a protective wrap inside athletic footwear
  - 48 rolls per case
  - Specify color
- Color Options: **Black, Blue, Gold, Green, Lime, Maroon, Natural, Navy, Orange, Pink, Purple, Red.**

**1405975** 2.75" x 30 yards per roll \$59<sup>22</sup> CASE

- Red
- Blue
- Pink
- Green
- Orange
- Natural
- Lime
- Gold
- Purple
- Navy
- Black
- Maroon



**Mueller MTAPE**

- 100% cotton backcloth, zinc oxide white trainer's tape
- High tensile strength with excellent tackiness
- Easy unwind to core
- 1 1/2" x 15 yard rolls

**1292695** 32 rolls per case \$79<sup>22</sup> CASE



**Johnson & Johnson**

**5188 ATHLETIC TAPE**

- High-quality, breathable porous athletic tape protects joints from sprains and injury
- Provides support to speed recovery after injury
- Packaged in SPEED PACK®
- Each roll is 1 1/2" x 15 yds
- 32 rolls per case

**1420363** Case of 32 \$89<sup>22</sup> CASE



**Mueller TAPE WRAP PREMIUM**

- Excellent alternative to pre-wraps, compression wraps, wound care and fixation bandages.
  - Cohesive, breathable, sweat-resistant, high tensile, lightweight and easy tearing.
  - 2" x 6 yards is 24 rolls per case
  - 3" x 6 yards is 16 rolls per case
  - Specify color
- Color Options: **Black, White.**

**1348606** 2" - Specify Color \$54<sup>22</sup> EA  
**1348613** 3" - Specify Color \$64<sup>22</sup> EA



**BANDAGE SCISSORS**

- Flat-tipped bottom blade slips safely under tape and bandages
- Stainless steel, 7.25" blade

**1078695** \$19<sup>22</sup> EA



**Mueller TEAR-LIGHT TAPE**

- Superior adhesive
- Excellent comfort
- Ideal for securing lateral knee braces as well as compression wrap or fixation bandages for padding and cold packs
- Available in 2" or 3" wide rolls

**1419991** 2" x 5 yd - 24 rolls/case \$69<sup>22</sup> CASE  
**1155143** 3" x 5 yd - 16 rolls/case \$79<sup>22</sup> CASE



**SHARK TAPE CUTTER**

- Cuts through tape and bandage material with ease.
- Made of the highest quality Valox resin, fiberglass-reinforced for durability.
- 8.25" L

**1082517** \$16<sup>22</sup> EA

**COURT GRIP™**

**COURT GRIP**

- Simply apply to the bottom of player's sneakers
- Increases court traction on dusty courts
- Helps prevent injuries from court slippage
- Durable microfiber applicator

<b>1366543</b>	Basketball	\$92 <sup>22</sup>	CASE OF 8
<b>1348057</b>	Basketball	\$399 <sup>22</sup>	CASE OF 36
<b>1348071</b>	Volleyball	\$139 <sup>22</sup>	CASE OF 12



**ENDURACOOOL™**  
INSTANT COOLING TOWEL-LG

**ENDURACOOOL™ TOWEL**

- Cools instantly when wet - last up to 2 hours
  - Wearable Ultra Violet Protection Factor (UPF) 45 provides sun protection when covering the skin
  - Reusable and machine washable with detergent
- Color Options: **Black, Blue, Pink.**

<b>1366539</b>	Specify Color	\$12 <sup>22</sup>	EA
----------------	---------------	--------------------	----



**PUREGREEN24® DISINFECTANT**

- The first "green" hard surface disinfectant registered with the EPA; Recognized as a ChildSafe product by Grassroots Environmental Education
- Fast bacterial/ viral/ fungal kill times and can be applied in the presence of humans and animals
- **Kills MRSA AND HINI (SWINE FLU)**
- 24 hr. residual protection against Staph & Salmonella
- Non-toxic, non-caustic and non-staining
- Safe for use on synthetic turf fields
- No rinsing or protective gear required for skin contact
- No fumes, disinfects without bleaching

<b>1250022</b>	4 oz. Spray Bottle	\$9 <sup>22</sup>	EA
<b>1250039</b>	32 oz. Spray Bottle	\$22 <sup>22</sup>	EA
<b>1250046</b>	1 Gallon Refill	\$72 <sup>22</sup>	EA



**2XL GYM WIPES**

- EPA registered disinfectant wipes in a 700 count (extra-thick, super-absorbent 8" x 6" towelette size) designed to sanitize surfaces
- Alcohol-free, bleach-free and phenol-free
- Gym Wipes Antibacterial Towelettes, are pre-moistened, disposable, surface disinfecting wipes, that have been developed to stop cross-contamination on surfaces
- Gym Wipes will sanitize surfaces and kill 99.9% of germs that can cause illness
- Antibacterial Towelettes are proven to kill bacteria such as Salmonella choleraesuis, ATCC #10708, and E. coli, ATCC #11229

<b>1240689</b>	2 Reusable Buckets (700 sheets each)	\$99 <sup>22</sup>	EA
<b>1240696</b>	4 Refill Packs (700 sheets each)	\$194 <sup>22</sup>	EA
<b>1249163</b>	Wall Mount Dispenser	\$64 <sup>22</sup>	EA



**MATT-KLEEN™ ALL PURPOSE DISINFECTANT CLEANER**

- Helps stop the spread of skin diseases and infections
- Ideal for wrestling and gymnastic mats, training tables and shower floors
- Highly concentrated; 2 oz. makes one full gallon

<b>1092479</b>	Gallon	\$79 <sup>22</sup>	EA
----------------	--------	--------------------	----



**WHIZZER®**

- Multipurpose concentrate kills HIV-1 (AIDS virus), MRSA, Hepatitis B & C, and other viruses. Kills strep, staph and fungus germs on contact.
- Cleaner, fungicide, mildewstat, virucide and deodorizer - all in one. Comes complete with 2 FREE Pint spray bottles.
- Economical. One ounce of concentrate mixed with water makes a gallon of full-strength disinfectant. 128 dilutions per gallon.
- Fast. Apply directly to mats, floors, walls, training tables, locker rooms, or personal items. Just wipe dry.

<b>1155235</b>	1 Gallon + 2 FREE Pint Spray Bottles	\$59 <sup>22</sup>	EA
----------------	--------------------------------------	--------------------	----



**BIO HAZARD KIT**

- Kit includes: safety shield/mask, impervious gown, Disposable gloves, bio-waste bag, antimicrobial hand wipe, Disposal bag with ties, germicidal disinfectant with dry wipe, pick-up scoop with scraper and a red Z pouch.

<b>1205503</b>		\$39 <sup>22</sup>	EA
----------------	--	--------------------	----





### LIGHTED WAND

- Ideal for traffic direction in school zone
- Easy on-off with blinking or solid light
- Requires (2) size D batteries (not included)
- 16" long

I277173

\$19<sup>22</sup> EA



### PENNANT STREAMERS

- Rope streamers with 18" plastic pennants in a variety of colors: Blue, Green, Red, White and Yellow
- Use to dress up your field, crowd control or for cross-country events
- Sold in lengths of 100' (approx. 48 flags per 100')

I260XXXX

Streamers

\$17<sup>22</sup> EA ★

### STORAGE BAG

- Zippered nylon bag with handles holds 3 deflated cones

I245097

Storage Bag

\$2<sup>22</sup> EA ★



### ROPE POSTS

- 5' galvanized steel post with pointed end for easy insertion into ground
- Minimum order of 6

1041392

Post only

\$31<sup>22</sup> EA



### TRAFFIC SAFETY VESTS

- Class II 100% solid polyester fluorescent lime safety vest with 2" silver reflective striping and adjustable front closure
- Vest has a left bottom pocket, a left chest pocket and a right inside pocket
- Ideal for a crossing guard or for traffic safety



I276879

Size: Large \$18<sup>22</sup> EA

I276886

Size: XXL \$18<sup>22</sup> EA

### ORANGE GAME CONES

- Flexible PVC with weighted base for added stability
- Stack easily for storage



I040814

12"

\$8<sup>22</sup> EA ★

I040838

18"

\$10<sup>22</sup> EA ★

I040845

28"

\$29<sup>22</sup> EA

I040852SET

36"

\$209<sup>22</sup> SET OF 5

### PLASTIC CLIP-ON CONE SIGN

- 13"H x 12"W message sign fits open top cones
- Simply clip into the cone opening and you have a double-sided dry erase sign for station messages, directions and more
- Uses dry erase markers only
- Cones sold separately

73558

\$24<sup>22</sup> EA



Sign not included

### ECONO CLASSIC SIGN STAND

- Holds 24" x 36" signs (signs not included)
- Displays (2) signs per frame
- Accepts signs made of Colorplast™ foamboard, acrylic, or aluminum
- All plastic: no rust, splinters or maintenance
- White only - 11 lbs.

I292121

Size: 42"H x 27"W

\$69<sup>22</sup> EA



Sign not included

### SIMPO SIGN II STAND

- Holds 22" x 28" signs (signs not included)
- Displays (2) signs per frame
- Blank signs quickly slide in and out and stay securely in place
- All plastic: no rust, splinters, or maintenance
- White only - 8 lbs.

I276664

Size: 36"H x 24"W

\$59<sup>22</sup> EA





**MONSTER BALL CART**

- Fabricated from 1" square steel
  - Black powder coated finish
  - Holds 15 official size basketballs
- 7 Year Limited Warranty**

**1162608** 30"H x 49"W x 20"D - 30 lbs. \$299<sup>99</sup> EA ★



**DOUBLE MONSTER BALL CART**

- Fabricated from 1" square steel
  - Black powder coated finish
  - Holds 30 official size basketballs
- 7 Year Limited Warranty**

**1162615** 30"H x 49"W x 24"D - 54 lbs. \$429<sup>99</sup> EA ★



**BASKETBALL BUTLER**

- Keep basketballs off the ground and ready to use
- Welded steel with powder coated finish
- Attaches to round posts up to 4 1/2" O.D. (hardware included)
- Can also be wall mounted (hardware not included)

1249156 2 Ball \$59<sup>99</sup> EA  
1253641 4 Ball \$109<sup>99</sup> EA



3-Row

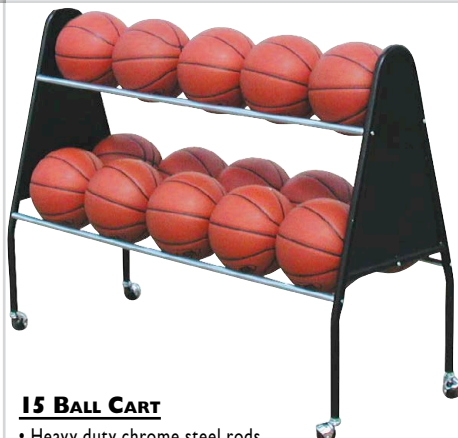

**15 BALL CART**

- Heavy duty chrome steel rods
- Solid triangular frames for strength and stability
- Non-marring casters
- Wide base design prevents tip over
- Holds 15 official size basketballs

**1159639** 38"H x 51"W x 19"D - 10 lbs. \$99<sup>99</sup> EA ★



**WALL MOUNT BALL RACK**

- Chrome plated 1" steel tubing construction
- Easy to install with 4 screws (not included)
- Will hold up to 18 balls on 3 levels

**1197739** 40"H x 60"W x 15"D - 18 lbs. \$154<sup>99</sup> EA ★

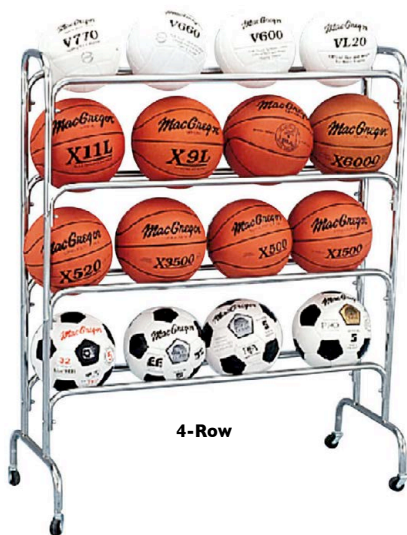

4-Row



**HEAVY-DUTY BALL CARTS**

- Welded 1" square wall tubing with 3/4" steel chrome plated, ball support arms
  - Non-marring, high quality 360° swivel casters
  - Extra wide wheel base avoids tipping
  - Add a school or mascot name, up to (10) letters, to the end panels (lettering sold separately and is not applied by manufacturer)
- 5 Year Limited Warranty**

Color Options: **Grey, Royal Blue, Scarlet, White.**

1048452 12 Ball Cart \$349<sup>99</sup> EA  
1048490 18 Ball Cart \$399<sup>99</sup> EA  
1245899 Lettering \$69<sup>99</sup> EA



**DOUBLE-WIDE STEEL BALL CART**

- Made of 1" rugged chrome steel
- Holds 30 full size basketballs
- Comes with heavy duty swiveled rubber casters

**1237634** 33"H x 45"W x 24"D - 35 lbs. \$179<sup>99</sup> EA ★

**WIDE BODY BALL CARTS**

- Heavy duty chromed steel tubing
- Non-marring, hard rubber casters with a wide, no-tipple base
- Designed for easy storage and removal of balls

**MCCRT12W** 3 Row, 12 Balls \$69<sup>99</sup> EA ★  
**MCCRT16W** 4 Row, 16 Balls \$74<sup>99</sup> EA ★



### STANDARD PORTABLE BALL LOCKER

- 1" steel tubing frame
- Holds up to 20 basketballs
- Hinged cover can be locked (lock not included)

**12002100** 43"H x 46"W x 26"D - 35 lbs. \$279<sup>22</sup> EA ★



### DOUBLE-SIDED BALL LOCKER

- Heavy duty 1" powder coated steel outside frame
- 5mm PVC coated steel mesh
- Allows for divided storage of balls
- Each side can be locked (locks not included)
- Holds up to 30 basketballs or volleyballs
- 8" back wheels allow for easy movement
- Fits through a standard doorway

**1237627** 44"H x 63"W x 24"D - 60 lbs. \$359<sup>22</sup> EA ★ **S&H**



### E-Z FOLD CART

- Aluminum square frame
- Nylon top with mesh bottom
- Holds 20 basketballs or 30 volleyballs
- Non-marring swivel casters
- Folds to only 6" wide for easy storage

**MCVBCARTY** 40"H x 24"W x 24"D \$124<sup>22</sup> EA ★



1. 2.

### WALL MOUNTED BALL LOCKERS

- Constructed of 1" black powder coated steel tubing
- Permanently mounts to your gym wall (hardware not included)
- Holds 6 basketballs; Double model holds 16 basketballs or 30 volleyballs
- Double model includes locking bars at the top and bottom to secure balls (locks sold separately)

**1. 1173123** 66"H x 15"W x 12"D \$159<sup>22</sup> EA ★  
**2. 1162578** 66"H x 37"W x 12"D \$229<sup>22</sup> EA ★



### COMPACT BALL LOCKER

- Constructed of 1" powder coated steel tubing
- Holds up to 30 inflated balls
- Can be padlocked (lock not included)
- Larger rear wheels roll smoothly over rough terrain
- Includes mesh ball bag

**1362605** 46"H x 26"W x 28"D - 42 lbs. \$159<sup>22</sup> EA ★



### MONSTER BALL LOCKER

- Constructed of 1" powder coated steel tubing
- Holds 30 official basketballs or 40 volleyballs
- Features over sized 4" wheels for easy movement
- The top is lockable (lock not included) and contains special hinges and safety chains to prevent top from falling over

**1162622** 37"H x 47"W x 24"D - 75 lbs. \$479<sup>22</sup> EA ★



### LOK-RACK BALL STORAGE

- Constructed of 1/2" square steel tubing
- Can be stood on end in storage rooms
- Balls can be secured with any standard padlock (lock not included)

**1237641** 10 Balls: 28"H x 49"W x 16"D - 50 lbs. \$499<sup>22</sup> EA  
**1237658** 15 Balls: 38"H x 49"W x 16"D - 75 lbs. \$649<sup>22</sup> EA **S&H**  
**1237665** 20 Balls: 28"H x 49"W x 26"D - 100 lbs. \$799<sup>22</sup> EA **S&H**



### ALL TERRAIN BALL LOCKER

- 7/8" steel tubing frame w/ red powder coated finish
- Durable, welded wire mesh body
- Can be padlocked (lock not included)
- Heavy duty, 16" poly spoked wheels on rear
- 4" swivel casters on front
- Holds 15 official basketballs or 25 volleyballs

**1342758** 38"H x 46"W x 30"D - 50 lbs. \$409<sup>22</sup> EA ★



### DELUXE PORTABLE BALL LOCKER

- Constructed of 3/4" powder coated steel tubing
- Lockable, hinged cover (lock not included)
- Heavy duty multi-directional wheels

**STBALLOC** 40"H x 40"W x 26"D - 50 lbs. \$299<sup>22</sup> EA ★ **S&H**



### MULTI-PURPOSE EQUIPMENT WAGON

- All steel construction with pneumatic tires
- Use for carrying equipment, water containers, or field storage
- Front, rear, and side panels fold away for easy loading/unloading
- 1400 lb. weight capacity

1291766 11"H (sides) x 24"W x 48"L \$309<sup>22</sup> EA ★



### DELUXE TEACHING CART

- Powder coated steel frame, vinyl coated basket with foam grip
- Rubber 4" wheels with sealed ball bearings
- Locking lid that lays flat against the side
- Includes basket hanger and convenient water bottle holder
- Holds 325 tennis balls
- Basket Height - 42 1/2"H
- Top Basket - 19" W x 23"L

1342550 \$259<sup>22</sup> EA ★



### COLOSSAL VOLLEYBALL CART

- Nylon basket includes side pockets for storage
- Holds 40 volleyballs
- Black only

1274417 38"H x 42"W x 32"D \$199<sup>22</sup> EA



### BATTING PRACTICE BALL CART

- Constructed of heavy duty 1.5" O.D. powder coated steel
- Large capacity basket: 16"H x 20"W x 25"L
- Holds hundreds of balls
- Oversize 14" No-flat tires

1291568 \$219<sup>22</sup> EA ★



### MULTI-PURPOSE EQUIPMENT CART

- Constructed of 1" powder coated steel tubing
- Great for carrying PE and baseball equipment
- Polyester bag measures 24"H x 24"W x 12"D

1197655 46"H x 29"W x 30"D - 29 lbs. \$199<sup>22</sup> EA ★



### RACQUET CART

- Galvanized steel construction
- Holds up to 64 tennis rackets or 100 table tennis paddles
- Non-marring casters for easy transport

1690XXXX 32"L x 14"W x 28"H \$79<sup>22</sup> EA ★



### LARGE PORTABLE EQUIPMENT CART

- Safe, secure, highly visible wire storage center
- 2" square grid, nickel chrome finish
- Double door opens a full 270° and is lockable
- Comes with (4) 5" polyurethane swivel casters
- Interior shelves sold separately
- Assembly required - 1000 lb. capacity

92448XXX 69"H x 50"W x 26"D \$999<sup>22</sup> EA  
92449XXX Shelf 48"W x 24"D \$99<sup>22</sup> EA



### SCOOTER BOARD/CONE CART

- 1" diameter, powder coated silver, steel tubing
- Holds up to (28) 12" scooters with or without handles
- Large 10" rubber wheels
- Stores and transports game cones too

1375089 47"H x 32"W x 19"D \$199<sup>22</sup> EA ★



**NEW!**

### CONE CART

- Holds (60) 12" pvc or (200) plastic cones
- 1" diameter steel tube frame w/ silver powder coated finish
- 10" semi pneumatic wheels with roller bearings

1362619 45"H x 26"W x 16"D - 30 lbs. \$149<sup>22</sup> EA ★

**NEW!****BULK STORAGE CART**

- Transport most anything in this heavy-duty PVC cart
- Durable plastic bottom board will hold laundry, balls or equipment
- Rolls easily

1366522 17"H x 47"W x 23"D - 47 lbs. \$289<sup>22</sup> EA**P.E. RECESS CART**

- Store and transport equipment and balls frequently used during recess
- Holds up to (30) basketballs, soccer balls, 8.5" playground balls or volleyballs
- Also holds (100) jump ropes and (50) hoops of various sizes

1188318 72"H x 63"W x 19"D \$329<sup>22</sup> EA ★**FOLDING LAUNDRY CART**

- Commercial cart that folds for easy storage
- Complete with nylon laundry bag and 3" casters
- Assembly required

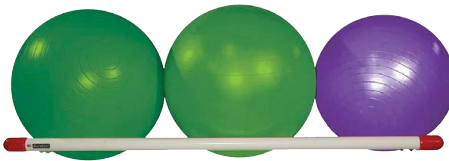
**Lifetime Warranty**1378278 36"H x 25"W x 25"D \$229<sup>22</sup> EA**NEW!****STABILITY BALL WALL RACK**

- Wall-mounted stability ball rack (hardware not included)
- Conveniently holds 3 medium or 2 large fitness balls

1369556 55"W x 18"D - 6 lbs. \$69<sup>22</sup> EA**FITNESS STEP CART**

- Large capacity storage rack and transporter for fitness steps and resistance tubes
- Lightweight and durable
- This cart will safely store up to (32) 4" steps or (16) 6" steps plus resistance tubes
- Features include heavy-duty, ball bearing, swivel, non-marring casters with a roll lock feature
- Easily goes through standard doorway

1188332 60"H x 45"W x 19"D \$269<sup>22</sup> EA

2. Divided

1. Single

**LARGE LAUNDRY CARTS**

- Bag is constructed of heavy duty canvas and removes easily with hook and loop fasteners
- Chrome plated steel frame
- Load capacity: 7 bushels, 51 gallons, 100 lbs.
- Support bars under bag
- 2½" casters, two with brake and 4 caster bumpers
- Outer dimensions: 36½"H x 38½"W x 24¼"D
- Inner dimensions: 23"H x 30½"W x 19½"D
- Assembly required

**Lifetime Warranty**1. 1378279 Single Compartment \$209<sup>22</sup> EA2. 1378280 Divided Compartments \$229<sup>22</sup> EA**STABILITY BALL CART**

- Stores and safely transports stability balls with a diameter of 16" or larger, plus jump ropes, exercise bands and resistance tubes
- Lightweight PVC, yet strong, durable and maintenance free
- Roll lock casters secure cart in place with the push of a lever
- Easily passes through a standard doorway

1257557 67"H x 67"W x 19"D \$279<sup>22</sup> EA **JUMP ROPE/HOOP RACK**

- Stores and transports over 120 jump ropes (up to 10' long) plus hoops
- Large base for increased stability
- Bar heights of 56", 62" and 68" allow children and adults to easily access the correct size jump rope
- Easily goes through standard doorway

1188325 68"H x 27"L x 19"D \$169<sup>22</sup> EA**MULTI TERRAIN ALL PLAY CART**

- Large rubber wheels on back
- Non-marring swivel, locking casters on front
- Cart will transport up to (24) soccer balls or basketballs plus jump ropes, hoops and more
- Includes (2) heavy-duty baskets
- Easily goes through standard doorway

1257526 65"H x 52"W x 24"D \$389<sup>22</sup> EA

*Show Your Opponents That They Are In Your House!*



### Wall Mat Construction

- Used primarily behind basketball goals to absorb impact and reduce injuries
- Constructed of 1/2" Novaply wood backing with your choice of either Crosslink Polyethylene Foam, 100 ILD High Density Polyurethane or combine both for a dual density pad
- Covered in 18 oz. vinyl with a 1" lip at the top and bottom for attachment to the wall
- Corner round molding or aluminum channel (not included) may be used to cover bolt heads after installation (installation hardware not included)

### Combine Art With Performance

- Special, durable inks are used that produce extreme and intense, life size outdoor quality images
- The vinyl is protected with a special lamination process to add durability and prevent fading

### It's Quick and Easy

- Send us a (copyright free) high resolution digital vector file or choose from our library of in-house mascot images
- For an additional charge, our designers will create or enhance your existing artwork
- All images and additional charges will be sent to you for approval prior to printing on pads

### WALL PADS WITH GRAPHICS

#### 1 3/8" Crosslink Polyethylene

20028347	2' x 5' x 1 3/8"	\$197 <sup>22</sup> EA	
20028353	2' x 6' x 1 3/8"	\$218 <sup>22</sup> EA	
20028360	2' x 7' x 1 3/8"	\$249 <sup>22</sup> EA	

#### 2" High Density Polyurethane

20028351	2' x 5' x 2"	\$207 <sup>22</sup> EA	
20028358	2' x 6' x 2"	\$229 <sup>22</sup> EA	
20028364	2' x 7' x 2"	\$269 <sup>22</sup> EA	

#### 2 1/2" Combination Wall Pads

20028349	2' x 5' x 2 1/2"	\$218 <sup>22</sup> EA	
20028355	2' x 6' x 2 1/2"	\$239 <sup>22</sup> EA	
20028362	2' x 7' x 2 1/2"	\$280 <sup>22</sup> EA	

### WALL PADS WITHOUT GRAPHICS\*

#### 1 3/8" Crosslink Polyethylene

20028348	2' x 5' x 1 3/8"	\$103 <sup>22</sup> EA	
20028354	2' x 6' x 1 3/8"	\$124 <sup>22</sup> EA	
20028361	2' x 7' x 1 3/8"	\$145 <sup>22</sup> EA	

#### 2" High Density Polyurethane

20028352	2' x 5' x 2"	\$124 <sup>22</sup> EA	
20028359	2' x 6' x 2"	\$145 <sup>22</sup> EA	
20028365	2' x 7' x 2"	\$156 <sup>22</sup> EA	

#### 2 1/2" Combination Wall Pads

20028350	2' x 5' x 2 1/2"	\$134 <sup>22</sup> EA	
20028356	2' x 6' x 2 1/2"	\$156 <sup>22</sup> EA	
20028363	2' x 7' x 2 1/2"	\$166 <sup>22</sup> EA	

### WALL PAD ACCESSORIES

G870YXXX	6' Aluminum Channeling	\$53 <sup>22</sup> SET	
20028346	Cut Out	\$83 <sup>22</sup> EA	
20028345	Corner Pad	Call for Pricing	
20028357	I-Beam Pad For Up to 8" Face	\$312 <sup>22</sup> EA	

**COLOR CHOICES: Choose from 14 school colors, in solids or alternating panel colors.**

Due to dye lots and natural variations, vinyl colors may vary slightly if ordered at separate times.

**Black**

**Columbia**

**Dark Green**

**Grey**

**Kelly**

**Maroon**

**Navy**



*Enhance The Safety & Appearance Of Your Gym & Play Areas!*

**LET US GUIDE YOU THROUGH THE ENTIRE ORDERING PROCESS!**



**WALL PADS**



**WALL PADS**

- Provides protection for indoor impact areas
- Perfect for basketball courts, gymnastics areas, wrestling facilities, rehab centers and more
- Installs easily and the brightly colored pads will enhance the appearance of your facility
- Made of 7/16" thick wood backing, 18 oz. vinyl, and have a 1" lip at the top and bottom for attachment to the wall
- We recommend our Aluminum Channeling for mounting your wall pads, but can be bolted in place - hardware not included
- Covered material meets California Fire Marshall's specifications for flammability
- Available colors: **Black, Columbia Blue, Dark Green, Grey, Kelly Green, Maroon, Navy Blue, Orange, Purple, Red, Royal Blue, Tan, White or Yellow**
- You may also order a combination of colors
- **Please contact us for pricing on custom wall pads, column pads or cut outs**

G875YXXX	2' x 5' x 1 3/8" Cross Link Polyethylene	\$119 <sup>22</sup> EA
G876YXXX	2' x 6' x 1 3/8" Cross Link Polyethylene	\$134 <sup>22</sup> EA
G877YXXX	2' x 7' x 1 3/8" Cross Link Polyethylene	\$150 <sup>22</sup> EA
G872YXXX	2' x 5' x 2" High Density Urethane	\$129 <sup>22</sup> EA
G873YXXX	2' x 6' x 2" High Density Urethane	\$150 <sup>22</sup> EA
G874YXXX	2' x 7' x 2" High Density Urethane	\$166 <sup>22</sup> EA
1045826	Cutouts for Wall Fixtures (Standard Sizes)	\$45 <sup>22</sup> EA



**ALUMINUM CHANNELING FOR WALL PADS**

- Fastest and easiest method for attaching wall padding to your walls
- Pads fit into the channeling securely and lock-in at the top for a smooth, neat appearance (no ugly bolts or screws to cover up)
- Worn or damaged pads can be easily removed and replaced one panel at a time by simply removing the top channel
- Includes top and bottom channels
- Sold in 6' lengths

G870YXXX	6' Aluminum Channeling	\$53 <sup>22</sup> SET
----------	------------------------	------------------------

**Orange**

**Purple**

**Red**

**Royal**

**Tan**

**White**

**Yellow**





### FLAME RETARDANT WALL PADS

- Class A pads are constructed of 7/16" OSB Board, with 2" highly flame resistant polymerized open cell foam and covered with 16 oz. FR rated vinyl
- Pads have a 1" lip top and bottom for attachment to the wall
- Corner round molding or aluminum channel (**not included**) may be used to cover bolt heads after installation (**installation hardware is not included**)
- Pads comply with the standards set forth by ASTM E84
- Meets NFPA 255, UL 723, ANSI 2.5 and UBC 8-1 (42-1)
- Available colors: Black, Columbia Blue, Dark Green, Grey, Kelly Green, Maroon, Navy Blue, Orange, Purple, Red, Royal Blue, Tan, White and Yellow

**CERTIFICATE OF COMPLIANCE**



#### With Graphics

I248029	2' x 5' x 2"	\$239 <sup>22</sup> EA	
I248036	2' x 6' x 2"	\$279 <sup>22</sup> EA	
I248043	2' x 7' x 2"	\$322 <sup>22</sup> EA	

#### Without Graphics

I247992	2' x 5' x 2"	\$166 <sup>22</sup> EA	
I248005	2' x 6' x 2"	\$197 <sup>22</sup> EA	
I248015	2' x 7' x 2"	\$218 <sup>22</sup> EA	



### I-BEAM PADS

- Designed to minimize the risk for injury from contact with a steel support I-beam
- Crafted to provide maximum protection, durability and ease of installation
- Pads are 6' H, covered with 18 oz. vinyl and filled with 4" high density polyfoam
- Fits beams up to 8" wide
- Available in **Black, Columbia Blue, Dark Green, Grey, Kelly Green, Maroon, Navy Blue, Orange, Purple, Red, Royal Blue, Tan, White or Yellow**
- Please specify color

G862YXXX \$329<sup>22</sup> EA



### COLUMN PADS

- Provide protection against collisions with support posts and poles
- Easily installed and enhances the appearance of your facility
- Available for both free-standing and in-wall supports

Call for more information and pricing on our column pads.



### MADE IN 8" WIDE SECTIONS

### STAGE PADS

- If your gymnasium is also used as an auditorium or theater, you need our stage pads to reduce the chance of injury
- Custom made to your specific application
- The inboard side of the fold is beveled so the edge of the stage is fully padded
- Fastener strips are included to prevent the pad from shifting, sliding or detaching while in use
- Manufactured using 1 3/8" crosslink polyethylene foam covered in 18 oz. vinyl
- Available in **Black, Columbia Blue, Dark Green, Grey, Kelly Green, Maroon, Navy Blue, Orange, Purple, Red, Royal Blue, Tan, White or Yellow**
- Please specify color

G861YXXX \$18<sup>22</sup> SQ.FT

### COLOR CHOICES: Choose from 14 school colors, in solids or alternating panel colors.

Due to dye lots and natural variations, vinyl colors may vary slightly if ordered at separate times.

**Black Columbia Dark Green Grey Kelly Maroon Navy Orange Purple Red Royal Tan White Yellow**





**BUY THE PACK AND SAVE!**



### RECESS PACKAGE

**Package Includes:**

- 6 cones (6")
- 1 set of throwdown bases
- 1 poly bat (29 1/2")
- 6 plastic baseballs
- 6 flying discs
- 2 Poof foam footballs
- 2 Poof foam soccerballs
- 1 Poof foam basketball
- 4 rubber basketballs (2 each official, junior)
- 2 size 4 rubber soccerballs
- 2 Enduro playground balls (8 1/2")
- 1 Fun Gripper football (8 1/2")
- 10 segmented jump ropes (4 each 7', 8' and 2 each 16')
- 4 hi-bounce spongy balls
- 1 hand inflator
- 1 mesh ball bag

**1179354** 54 Pieces \$259<sup>22</sup> SET ★



### SIX-COLOR STARTER SET

Package includes: One **Blue, Green, Orange, Purple, Red and Yellow** of each item.

- Junior footballs
- Junior basketballs
- Size 4 soccer balls
- Official volleyballs
- 8 1/2" playground balls
- 6" color cones
- Mesh bags

**99916XXX** 42 Pieces \$349<sup>22</sup> PACK ★



### DELUXE FIELD DAY PACKAGE

Includes everything needed to have a great day of fun-filled activities.

**Package Includes:**

- 12 Plastic batons
- 12 Potato sacks
- 1 Tug-o-war rope (75' long)
- 6 Game cones (12" high)
- 12 Low profile field cones
- 12 Flying discs
- 12 Plastic hoops (30" diameter)
- 24 Foam hoop holders
- 150 Latex balloons
- 6 Playground balls (8 1/2")
- 1 Stopwatch
- 150 Award ribbons (50 each 1st-2nd-3rd place)

**1251562** 398 Pieces \$409<sup>22</sup> PACK ★



### HAVE A BALL VALUE PACK!

**Package includes:**

- 12 VOIT® 8 1/2" colored playground balls
- 6 VOIT® Enduro CB2 official basketballs
- 6 MacGregor® size 5 rubber soccer balls
- 2 VOIT® Soft Shot rubber volleyballs
- 2 VOIT® CF9 senior size footballs

**999912XX** 28 Pieces \$229<sup>22</sup> SET ★

## Voit

### TUFF FOAM BALL PACKAGE

**Package includes:**

- 6 Voit 8 1/4" "Special" Tuff balls
- 6 Voit 6 1/4" "Softi" Tuff balls
- 6 Voit 5" Mini Tuff balls
- 3 Voit 6 1/4" Tuff dodgeballs
- 3 Voit Tuff soccerballs - size 4

**2 Year Limited Warranty**

**1179378** 24 Pieces \$399<sup>22</sup> SET ★

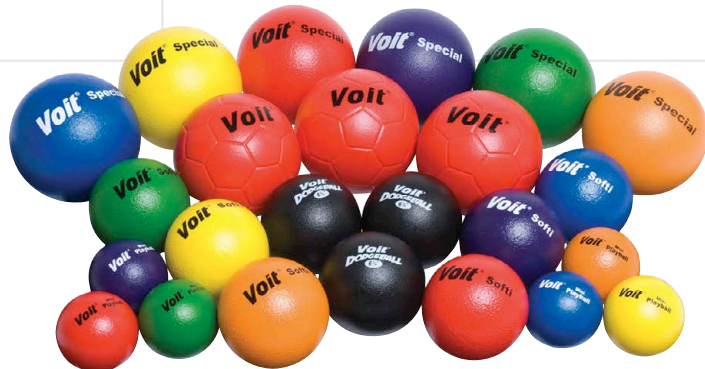

Add fun and excitement to your class and playground with our color management system. Use our system and provide each group with its own unique color. Eliminate arguments over whose equipment was left on the field or whose turn it is to play. If it's your color, it's yours. Color My Class® products are available in **Blue, Green, Orange, Purple, Red and Yellow**. Prism packs include - 1 of each color.



**MacGregor**

### MULTICOLOR BASKETBALLS

- Durable rubber construction
- Deep channels and enhanced pebbling
- Indoor/Outdoor use

Color Options: **Blue, Green, Orange, Purple, Red, Yellow.**

93602I	Official Size (29.5")	\$12.42	EA ★
93600	Official Size Prism Pack	\$65.22	PACK OF 6 ★
93502I	Intermediate Size (28.5")	\$12.42	EA ★
93500	Intermediate Size Prism Pack	\$62.22	PACK OF 6 ★
93402I	Junior Size (27.5")	\$12.42	EA ★
93400	Junior Size Prism Pack	\$59.22	PACK OF 6 ★
1308099	Colt (25.5") Prism Pack	\$57.22	PACK OF 6 ★
1268935	Lil' Champ (22") Prism Pack	\$55.22	PACK OF 6 ★



**MacGregor**

### MULTICOLOR SOCCERBALLS

- Top quality rubber construction
- Nylon windings and butyl bladder for superior strength and air-retention

Color Options: **Blue, Green, Orange, Purple, Red, Yellow.**

94502I	Size 5	\$12.22	EA ★
94500	Size 5 Prism Pack	\$59.22	PACK OF 6 ★
94402I	Size 4	\$11.22	EA ★
94400	Size 4 Prism Pack	\$52.22	PACK OF 6 ★
94300	Size 3 Prism Pack	\$49.22	PACK OF 6 ★



**MacGregor**

### MULTICOLOR FOOTBALLS

- Durable rubber construction
- Pebble grain exterior with raised laces for a superior grip
- Nylon windings and butyl bladder provides added strength and air-retention

Color Options: **Blue, Green, Orange, Purple, Red, Yellow.**

95902I	Official Size	\$12.22	EA ★
95900	Official Size Prism Pack	\$69.22	PACK OF 6 ★
95702I	Youth Size	\$11.22	EA ★
95700	Youth Size Prism Pack	\$66.22	PACK OF 6 ★
95602I	Junior Size	\$11.22	EA ★
95600	Junior Size Prism Pack	\$64.22	PACK OF 6 ★



**MacGregor**

### MULTICOLOR VOLLEYBALLS

- Durable rubber construction
- Regulation size and weight
- Nylon windings and butyl bladder construction provides added strength and increased air-retention

Color Options: **Blue, Green, Orange, Purple, Red, Yellow.**

91302I	Regulation Size	\$11.22	EA ★
91300	Prism Pack	\$59.22	PACK OF 6 ★

**INDIVIDUAL COLORS**

**WSU**  
WHILE SUPPLIES LAST



**MacGregor**

### COLOR MY CLASS® XTRA™

**Step Into The Next Generation!!**

- Launch your programs to the next level with these vibrantly colored balls
- Eye-popping colors make these balls easy to track
- Synthetic leather balls with PVC cushioned covers feature a swirling 3-D hologram
- Footballs have an "E-Z" grip material on each end that enhances catching and throwing
- Each set includes 1 of each neon color: **Blue, Green, Orange, Purple, Red and Yellow**

1255829	Junior Football	\$69.22	SET OF 6 ★
1255843	Size 4 Soccer Ball	\$69.22	SET OF 6 ★
1255850	Size 5 Soccer Ball	\$69.22	SET OF 6 ★
1255836	Regulation Volleyball	\$69.22	SET OF 6 ★



**Voit**

### ENDURO CS3 KICKBALL

- The original 8 1/2" playground kickball
- **Nylon wound** construction provides increased shape and air retention
- Durable but soft rubber cover for all your tough kicking activities

YCS3HXXX	Yellow	\$11.22	EA ★
1282108	Prism Pack	\$59.22	SET OF 6 ★



**Voit**

### 4-SQUARE UTILITY BALLS

- 8 1/2" nylon wound utility ball for increased air and shape retention
- Designed for the game of 4-Square or for kicking, striking and hard impact activities
- Prism Pack includes 1 of each color: **Blue, Green, Orange, Purple, Red and Yellow**

YCG8HXXX	Yellow	\$7.22	EA ★
1026634	Prism Pack	\$36.22	SET OF 6 ★



**Voit**

### LIGHT SPIKE

- Double knit soft polyester fabric cover allows players to practice skills without discomfort
- 30% lighter than official volleyball
- Ideal trainer for developing fundamentals safely

1342536		\$13.22	EA ★
---------	--	---------	------



# Voit

## PLAYGROUND BALLS

- The most widely used playground ball in the country!
- Please specify color where applicable

	Diameter	Color Options	
VPG5HXXX	5"	Red Only	\$4.62 EA ★
VPG6HXXX	6"	Blue, Green, Orange, Purple, Red, Yellow	\$5.12 EA ★
VPG7HXXX	7"	Red Only	\$5.62 EA ★
VPG85HXXX	8 1/2"	Blue, Green, Orange, Purple, Red, Yellow	\$6.12 EA ★
VPG10HXXX	10"	Blue, Green, Orange, Purple, Red, Yellow	\$7.12 EA ★
VPG13HXXX	13"	Red Only	\$11.22 EA ★
VPG16HXXX	16"	Red Only	\$15.22 EA ★

## PLAYGROUND BALL PRISM PACKS

- All prism packs include one of each color: **Blue, Green, Orange, Purple, Red and Yellow**

I369484	6"	\$30.22 SET OF 6 ★
I033472	8 1/2"	\$35.22 SET OF 6 ★
I369485	10"	\$41.22 SET OF 6 ★



2-PLY PLAYGROUND BALLS!



## COLOR MY CLASS® P.G. Sof's

- Roto-molded from foamed vinyl
- Combine the best features of playground balls and coated foam balls
- Supple, squeezable, sting-free and bounce like a rubber ball
- Vary the diameter of each ball for desired softness and bounce
- Each set includes 1 of each color: **Blue, Green, Orange, Purple, Red and Yellow**

I064957	8" Diameter Special	\$37.22 SET OF 6
I251913	7" Diameter Allround	\$36.22 SET OF 6
I251920	6" Diameter Playball	\$31.22 SET OF 6
I251937	3 1/2" Diameter Softball	\$21.22 SET OF 6
I255119	9 1/4" Long Football	\$38.22 SET OF 6
I255102	7 1/2" Long Football	\$34.22 SET OF 6



# Voit

## THE RAINBOW 48 PACK

- Pack includes forty eight 8 1/2" playground balls
- 8 each **Blue, Green, Orange, Purple, Red and Yellow**

**BUY THE PACK AND SAVE!**

I233179

\$259.22 PACK OF 48 ★



# Voit

## YELLOW ENDURO SERIES PLAYGROUND BALLS

### KICK 'EM - BAT 'EM - BOUNCE 'EM

- Designed for tough playground activities - kicking, batting, bouncing
- **Nylon wound** construction adds durability and air and shape retention
- Harder than standard playground balls
- Not recommended for bombardment activities

VPG6HNYL	6"	\$7.12 EA ★
VPG10HNY	10"	\$11.02 EA ★



# Voit

## 8 1/2" ENDURO SERIES PLAYGROUND BALLS

- Our toughest most durable playground ball!
  - **Nylon wound** for more durability and shape retention
  - Designed to withstand all high-impact playground activities
  - Should not be used for bombardment games
- Color Options: **Blue, Green, Orange, Purple, Red, Yellow.**

**EXTRA TOUGH!**

I54470  
I369483

Specify Color  
Prism Pack

\$7.62 EA ★  
\$44.22 SET OF 6 ★



## POOF

### FOAM BALLS

- Students successfully learn skills by eliminating the fear
- Spongy foam core with a durable, moisture resistant outer skin
- Great for restricted areas indoors or out
- Colors vary

<b>3169</b>	7 1/2" Size 3 Soccer Ball	\$12 <sup>22</sup> EA
<b>3166</b>	7" Size 3 Junior Basketball	\$10 <sup>22</sup> EA
<b>3168</b>	3/4 Size 9 1/2" Football	\$8 <sup>22</sup> EA
<b>1378321</b>	Pack of 3 Balls (1 of Each Ball)	\$29 <sup>22</sup> PACK OF 3



### COATED SPORTFOAM BALLS

- Both rugged and economical
- Light molded foam with micro-fine, durable vinyl coating
- Restricted flight for use in limited spaces indoors or out
- High visibility yellow can enhance eye-hand coordination

<b>5202XXXXY</b>	8 1/2" Volleyball	\$13 <sup>22</sup> EA ★
<b>5200XXXXY</b>	11" Long Football	\$13 <sup>22</sup> EA ★
<b>MSSBSPON</b>	12" Softball	\$5 <sup>22</sup> EA ★
<b>607XXXXXY</b>	7" Playball	\$10 <sup>22</sup> EA ★
<b>608XXXXXY</b>	8 1/2" Playball	\$16 <sup>22</sup> EA ★
<b>609XXXXXY</b>	10" Playball	\$21 <sup>22</sup> EA ★

### PLAYOFF™ FOAM TURBO FOOTBALL

- Unique foam football is grooved to make it easier to grip and throw
- Non-toxic powder construction makes it environmentally safe
- Dense construction for better performance and aerodynamics
- Colors may vary



<b>40199XXX</b>	8 1/2" Long	\$7 <sup>22</sup> EA
-----------------	-------------	----------------------

### CUSH-N-CATCH®

- Ideal for building athletic confidence in young children
- Restricted flight make these colorful, soft and durable balls perfect for use in limited spaces
- Features a nylon stitched, heavy-duty vinyl cover
- Recommended for K through 4



<b>MSCNCSBLY</b>	Softball	\$7 <sup>22</sup> EA ★
<b>MSCNCSOCY</b>	Soccerball	\$13 <sup>22</sup> EA ★
<b>MSCNCFBY</b>	Football	\$9 <sup>22</sup> EA ★

**NEW!**



### PRO GRIP FOOTBALL

- Classic-sized football features Pro Grip texture for throwing great spirals and catching like a pro
- Colors may vary



<b>1375319</b>	9" Long - Ages 4 and Up	\$18 <sup>22</sup> EA
----------------	-------------------------	-----------------------



### JELLY BALL

#### GRAB - PULL - BOUNCE - YEOW!

- Non-threatening elastic ball for squeezing, kicking and catching
- Super-light, super-tough material can take anything kids can dish out
- Vary inflation to adjust from low to medium bounce
- Features a re-inflatable valve and straw attachment for easy inflation
- Includes 1 of each color: **Blue, Green, Orange, Purple, Red and Yellow**



<b>1275025</b>	9" Prism Pack	\$42 <sup>22</sup> SET OF 6 ★
----------------	---------------	-------------------------------



### ECONOMY FOAM BALLS - UNCOATED

- Soft, lightweight balls for a variety of indoor activities
- Ideal for lead-up ball games
- Colors may vary

<b>MSFOAM3X</b>	3"	\$2 <sup>22</sup> EA ★
<b>MSFOAM4X</b>	4"	\$3 <sup>22</sup> EA ★
<b>MSFOAM6X</b>	6"	\$7 <sup>22</sup> EA ★
<b>MSFOAM7X</b>	7"	\$13 <sup>22</sup> EA ★
<b>MSFOAM8X</b>	8"	\$16 <sup>22</sup> EA ★



### HIGH DENSITY FOAM BALLS - UNCOATED

- Excellent for practice
- Flight characteristics similar to real balls

<b>MSVOLHB8</b>	Volleyball, 8" dia.	\$27 <sup>22</sup> EA ★
<b>MSVOLHB7</b>	Allround, 7" dia.	\$21 <sup>22</sup> EA ★
<b>MSVOLHB6</b>	Play Ball, 6" dia.	\$14 <sup>22</sup> EA ★



### FOAM TENNIS TRAINERS

- Slower and slightly larger than regular tennis balls
- Easier to track and hit

<b>MSVOLHB3</b>	3 1/2" dia.	\$3 <sup>22</sup> EA ★
<b>MSVOLHB2</b>	2 3/4" dia.	\$2 <sup>22</sup> EA ★

## Voittuff

AVAILABLE IN 4 SIZES!

**SOFT-LOW BOUNCE TUFF BALLS**

- Our coated foam balls are soft, squeezable and built to last
- Durable enough for all playground and indoor games
- Builds confidence and enhances skill development
- Easy to catch, grip and control
- Tear-resistant cover is washable, non-toxic and can be disinfected

**2 Year Limited Warranty**  
Color Options: **Blue, Green, Orange, Purple, Red, Yellow.**

<b>44075</b>	5" "Mini Playball" (Specify Color)	\$13.99 EA ★
<b>1181555</b>	5" "Mini Playball" (Prism Pack)	\$64.99 SET OF 6 ★
<b>440011</b>	6 1/4" "Softi" (Specify Color)	\$14.99 EA ★
<b>1179286</b>	6 1/4" "Softi" (Prism Pack)	\$78.99 SET OF 6 ★
<b>1369513</b>	7" "Seven" (Specify Color)	\$17.99 EA ★
<b>1369579</b>	7" "Seven" (Prism Pack)	\$97.99 SET OF 6 ★
<b>440101</b>	8 1/4" "Special" (Specify Color)	\$25.99 EA ★
<b>1236149</b>	8 1/4" "Special" (Prism Pack)	\$147.99 SET OF 6 ★

## Voittuff

### TUFF MEDIUM DENSITY SPECIALTY BALLS

- Firmer and larger than the Softi, yet appropriately sized for children
- Recommended for activities requiring greater ball action and weight than the Softi can provide

**2 Year Limited Warranty**

<b>4407</b>	Yellow All Around 7" dia.	\$23.99 EA ★
<b>4406</b>	Red Playball 6 1/2" dia.	\$19.99 EA ★

## Voittuff

### TUFF COATED FOAM SOCCER BALL

- Durable ball, perfect to learn lead-up skills
- Features high-density foam covered in "tuff" vinyl

**2 Year Limited Warranty**  
Color Options: **Blue, Green, Orange, Purple, Red, Yellow.**

<b>44017</b>	Size 4 (Specify Color)	\$28.99 EA ★
<b>1243987</b>	Size 4 (Prism Pack)	\$154.99 SET OF 6 ★
<b>1369585</b>	Size 5 (Specify Color)	\$29.99 EA ★
<b>1369584</b>	Size 5 (Prism Pack)	\$159.99 SET OF 6 ★

## Voittuff

### TUFF 6 1/4" DODGEBALL

- Soft, slow moving and easy to grip
- Perfect for target games (bowling pins, critters, cones) and dodgeball
- Soft, low density foam covered in a "Tuff" outer cover

**2 Year Limited Warranty**

<b>44020</b>	Black	\$13.99 EA ★
<b>1369507</b>	Prism Pack	\$76.99 SET OF 6 ★

## Voittuff

### TUFF COATED FOAM FOOTBALLS

- Lightweight, yet heavy enough for quality football action

**2 Year Limited Warranty**  
Color Options: **Blue, Green, Orange, Purple, Red, Yellow.**

<b>VTFTBL10</b>	9 3/4" Junior (Specify Color)	\$20.99 EA ★
<b>1243925</b>	9 3/4" Junior (Prism Pack)	\$119.99 SET OF 6 ★
<b>VTMNF891</b>	8 1/2" Mini (Specify Color)	\$17.99 EA ★
<b>1243864</b>	8 1/2" Mini (Prism Pack)	\$99.99 SET OF 6 ★

## Voittuff

### 6 1/4" NEON "SOFTI" TUFF BALLS

- Soft, squeezable coated foam balls in exciting neon colors
- Soft enough for indoor play and "tuff" enough for rugged playground activities
- Easy to catch, grip and control

**2 Year Limited Warranty**

<b>1274967</b>	Prism Pack	\$80.99 SET OF 6 ★
----------------	------------	--------------------



**CAGEBALLS**

- **A TRADITIONAL FAVORITE!**
- Multi-color ball for multi-player action
- Super-duty nylon cover over a durable, vinyl bladder with sonic welded seams
- Helps develop coordination and teamwork
- Inflate with a high powered inflator/deflator
- The bigger the ball, the more players you can use

**Complete Set**

<b>CAGEUN24X</b>	24" (2 lbs. 2 oz.)	\$42 <sup>22</sup> EA ★
<b>CAGEUN30X</b>	30" (3 lbs. 1 oz.)	\$49 <sup>22</sup> EA ★
<b>CAGEUN36X</b>	36" (6 lbs. 10 oz.)	\$72 <sup>22</sup> EA ★
<b>CAGEUN48X</b>	48" (7 lbs. 6 oz.)	\$129 <sup>22</sup> EA ★
<b>CAGEUN60X</b>	60" (11 lbs. 5 oz.)	\$184 <sup>22</sup> EA ★
<b>CAGEUN72X</b>	72" (17 lbs. 3 oz.)	\$259 <sup>22</sup> EA ★

**Cover Only**

<b>CAGE24CO</b>	24"	\$21 <sup>22</sup> EA ★
<b>CAGE30CO</b>	30"	\$25 <sup>22</sup> EA ★
<b>CAGE36CO</b>	36"	\$37 <sup>22</sup> EA ★
<b>CAGE48CO</b>	48"	\$64 <sup>22</sup> EA ★
<b>CAGE60CO</b>	60"	\$89 <sup>22</sup> EA ★
<b>CAGE72CO</b>	72"	\$139 <sup>22</sup> EA ★



**Bladder Only**

<b>CAGEBL24</b>	24"	\$22 <sup>22</sup> EA ★
<b>CAGEBL30</b>	30"	\$27 <sup>22</sup> EA ★
<b>CAGEBL36</b>	36"	\$39 <sup>22</sup> EA ★
<b>CAGEBL48</b>	48"	\$67 <sup>22</sup> EA ★
<b>CAGEBL60</b>	60"	\$99 <sup>22</sup> EA ★
<b>CAGEBL72</b>	72"	\$159 <sup>22</sup> EA ★



**HUMONGO BALLS**

- **Great Big Fun!**
- Extra heavy-duty, large balls have a no-seam vinyl bladder for heavy use indoors or outdoors
- Oversized balls are great for group activities
- Bladder inflates easily with a high power electric inflator/deflator
- Durable polyester cover can be removed easily for washing
- 40" diameter. Weighs only 7 lbs.

<b>1299403</b>	Soccer	\$79 <sup>22</sup> EA ★
<b>1299410</b>	Basketball	\$79 <sup>22</sup> EA ★
<b>1299427</b>	Volleyball	\$79 <sup>22</sup> EA ★
<b>1299434</b>	Baseball	\$79 <sup>22</sup> EA ★
<b>1299441</b>	Beach Ball	\$79 <sup>22</sup> EA ★



**KIN-BALL® SPORT BALLS**

- **FAST PACED EXCITING TEAM SPORT!**
- 3 teams of 4 players each try to keep this super lightweight ball from hitting the ground or the gym wall in this constant action game
- When a team has possession of the ball, every member of that team will touch the ball before serving to another team
- Promotes cooperation and teamwork
- Develops physical, social and critical thinking skills while being just plain fun

**3 Year Limited Warranty**

<b>24640</b>	48" KIN-BALL® Sport (Pink)	\$299 <sup>22</sup> EA
<b>20020170</b>	48" KIN-BALL® Sport (Black)	\$299 <sup>22</sup> EA
<b>1071450</b>	40"- 48" Replacement Bladder	\$54 <sup>22</sup> EA

**KIN-BALL® Accessories**

<b>24644</b>	How To Play KIN-BALL® DVD	\$39 <sup>22</sup> EA
<b>24646</b>	Official Rule Book	\$19 <sup>22</sup> EA
<b>24648</b>	Instruction Manual	\$22 <sup>22</sup> EA



**8' JUMBO BEACH BALL**

- Kids have a big imagination and this giant, multicolor ball will bring out their best
- 8' diameter vinyl beach ball is great for team building activities, push ball races, field day activities and more
- Includes an attached rope to help players control the ball
- Inflates using a high power electric inflator/deflator
- Weighs approximately 15 lbs.

**1255751** \$209<sup>22</sup> EA ★

**OMNIKIN® MULTICOLOR BALLS**

- Bright and ultra-light
- Use indoors and outdoors - throw, bounce, kick them
- Change traditional activities into giant-sized activities
- Includes nylon cover and 1 latex bladder

**3 Year Limited Warranty**

<b>24632</b>	33" Ball (1 lb. 7 oz.)	\$179 <sup>22</sup> EA
<b>24634</b>	40" Ball (2 lbs. 6 oz.)	\$239 <sup>22</sup> EA
<b>1071450</b>	40"- 48" Replacement Bladder	\$54 <sup>22</sup> EA
<b>1071467</b>	33" Replacement Bladder	\$42 <sup>22</sup> EA
<b>1313888</b>	24" Ball (1 lb.)	\$77 <sup>22</sup> EA
<b>1313895</b>	24" Replacement Bladder	\$24 <sup>22</sup> EA



**SPORTOGO™ GIANT SOCCER BALL**

- A rolling, bouncing good time for all
- Indoor/outdoor use - kick, hit, roll on it
- 100% double knit, washable cover + heavy-duty PVC bladder
- Includes instructions - Weighs only 4 lbs.

**90 Day Limited Warranty**

**22004** 40" Diameter \$89<sup>22</sup> EA



**OMNIKIN® INFLATOR**

- Made of lightweight, durable plastic
- Includes 3 adapters and dual handles
- Use on any large inflatable

**24630XXX** 4 1/2 HP \$259<sup>22</sup> EA



**ALL SPORT BALL INFLATOR / DEFLATOR**

- Best used with balls up to 30" diameter
- **Not for use with Omnikin® balls**
- Includes 3/4 Peak HP (75 CFM) 4.5 amp, 500 watt inflator/deflator motor, 2 tapered adapters (7/8" and 3/16" OD) and a 110V power cord

**NAATI4XX** \$69<sup>22</sup> EA  
**Z150NAATI4** Replacement Nozzle \$12<sup>22</sup> EA

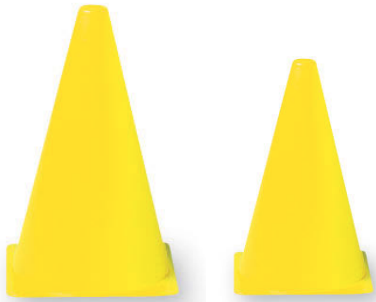

### ECONOMY CONES

- Lightweight vinyl with small base
- No hole in top

<b>MSCONE9XY</b>	9"	\$2 <sup>22</sup> EA ★
<b>MSI2CONEY</b>	12"	\$3 <sup>22</sup> EA ★



### ORANGE GAME CONES

- Flexible PVC with weighted base for added stability
- Stack easily for storage

<b>1040814</b>	12"	\$8 <sup>22</sup> EA ★
<b>1040838</b>	18"	\$10 <sup>22</sup> EA ★
<b>1040845</b>	28"	\$29 <sup>22</sup> EA
<b>1040852SET</b>	36"	\$209 <sup>22</sup> SET OF 5



### PENNANT STREAMERS

- Rope streamers with 18" plastic pennants in a variety of colors: Blue, Green, Red, White and Yellow
- Use to dress up your field, crowd control or for cross-country events
- Sold in lengths of 100' (approx. 48 flags per 100')



<b>1260XXXX</b>	Streamers	\$17 <sup>22</sup> EA ★
-----------------	-----------	-------------------------

### ROPE POSTS

- 5' galvanized steel post with pointed end for easy insertion into ground
- Minimum order of 6

<b>1041392</b>	Post only	\$31 <sup>22</sup> EA
----------------	-----------	-----------------------



### CONE CART

- Holds (60) 12" pvc or (200) plastic cones
- 1" diameter steel tube frame w/ silver powder coated finish
- 10" semi pneumatic wheels with roller bearings

<b>1362619</b>	45"H x 26"W x 16"D - 30 lbs.	\$149 <sup>22</sup> EA ★
----------------	------------------------------	--------------------------



### AVAILABLE IN 3 SIZES!

### COLOR MY CLASS® GAME CONES

- Flexible, PVC cones with weighted bases for increased stability
- Use to designate boundaries, lanes and teams
- Each set includes 1 of each color: **Blue, Green, Orange, Purple, Red and Yellow**

<b>1245875</b>	18" Prism Pack	\$69 <sup>22</sup> SET OF 6 ★
<b>1093452</b>	12" Prism Pack	\$43 <sup>22</sup> SET OF 6 ★
<b>MS6CONPK</b>	6" Prism Pack	\$28 <sup>22</sup> SET OF 6 ★
<b>MSCONE</b>	6" Cones (Specify Color)	\$4 <sup>22</sup> EA ★



### LOW PROFILE CONES

- Soft, flexible and stack easily
- Color code your drills for more effective practice time
- Available in Orange, Yellow or Prism Packs (2 each: Blue, Green, Orange, Purple, Red and Yellow)
- 3"H x 7 3/4" diameter

<b>1255706</b>	Orange	\$12 <sup>22</sup> DZN ★
<b>1276558</b>	Yellow	\$12 <sup>22</sup> DZN ★
<b>1255690</b>	Prism Pack	\$12 <sup>22</sup> DZN ★



### COLOR MY CLASS® SPOTS/MARKERS

- 9" diameter, soft, flexible, plastic markers
- Stick to gym floors without shifting
- Prism packs include either 1 or 2 of each color: **Blue, Green, Orange, Purple, Red and Yellow**

<b>6058SPOT</b>	Prism Pack	\$29 <sup>22</sup> DZN ★
<b>1309973</b>	Prism Pack	\$15 <sup>22</sup> SET OF 6 ★
<b>6059XXXY</b>	Orange	\$29 <sup>22</sup> DZN ★



**BEST SELLER**



**DELUXE PARACHUTES**

- **WE'VE RAISED THE STANDARDS!**
- Features durable, reinforced handles
- High quality nylon parachutes with an air-flow mesh center
- Perfect cool down activity for children with Autism Spectrum Disorder
- Storage bag included



1040005	6' Dia. - 8 Handles	\$25 <sup>99</sup> EA ★
1040012	12' Dia. - 12 Handles	\$59 <sup>99</sup> EA ★
1255874	20' Dia. - 16 Handles	\$129 <sup>99</sup> EA ★
1040029	24' Dia. - 20 Handles	\$159 <sup>99</sup> EA ★
1040036	30' Dia. - 24 Handles	\$229 <sup>99</sup> EA ★
1255881	35' Dia. - 28 Handles	\$319 <sup>99</sup> EA ★
1255898	45' Dia. - 32 Handles	\$449 <sup>99</sup> EA ★



**WEIGHTED BOWLING SET**

- This set plays almost like the real thing
- The weighted pins react more realistically when hit
- Set includes ten 15"H pins weighing about 10 oz. each, one 4 1/2 lb. ball, set up sheet and score pad

1248050 \$99<sup>99</sup> SET ★



**LIGHTWEIGHT BOWLING SET**

- Ideal for teaching the fundamentals of bowling to beginners
- Each set includes ten 15"H, lightweight, 5 oz. hollow pins, 5 lb. rubber ball, set-up sheet and score pad

1041149	Complete Set	\$89 <sup>99</sup> SET ★
PPSS27XXY	Replacement 5 lb. Ball	\$43 <sup>99</sup> EA ★
PPSS28XXY	Replacement 2 1/2 lb. Ball (2 Finger Holes)	\$25 <sup>99</sup> EA ★
PPSS24XX	Replacement Set of Pins, Set-Up Sheet and Score Pad	\$49 <sup>99</sup> SET ★



**ROLL OUT BOWLING LANE**

- Store this colorful 42"W x 20'L vinyl mat and roll it out when needed
- Lies flat after being brought out of storage
- Printed pin placement graphics assures pins will be set up correctly
- The printed directional arrows will have bowlers throwing strikes in no time
- Pins and balls sold separately

1274974 \$146<sup>99</sup> EA ★



**ECONOMY TUG-O-WAR ROPE**

- 1" diameter, top grade manila rope
- 72" loop and braided at each end

1040968	50'	\$94 <sup>99</sup> EA ★
1040975	75'	\$134 <sup>99</sup> EA ★
1040951	100'	\$149 <sup>99</sup> EA ★



**TEAMWORK TREKKERS**

- **WALK THIS WAY!**
- Designed to develop balance, coordination, agility and cooperation
- Students must communicate and work together in order to walk together
- Features a soft foam bottom that will not harm gym floors
- Use indoors or outdoors
- Recommended for ages 4 and up
- 5 1/2" wide

1026535	2-Person Trekker 36" L	\$74 <sup>99</sup> PR ★
1026542	4-Person Trekker 59" L	\$124 <sup>99</sup> PR ★
1026559	6-Person Trekker 96" L	\$174 <sup>99</sup> PR ★



**HOPPERS**

- A fun way to develop leg strength and balance
- Use as an aerobic workout indoors or out
- Heavy duty PVC cover is washable
- Available in 2 sizes
- 18" for ages 3 to 6 and 24" for ages 6 to 10

1039986	18" Hopper - Tie Dye	\$27 <sup>99</sup> EA ★
1256772	18" Hopper - Yellow	\$27 <sup>99</sup> EA ★
1039993	24" Hopper - Tie Dye	\$29 <sup>99</sup> EA ★
1256789	24" Hopper - Red	\$29 <sup>99</sup> EA ★



## HEAVYWEIGHT SASH ROPES

- Thick sash cord jointed into well shaped hollow handles

2546XXXX	8'	\$5 <sup>12</sup> EA ★
2547XXXX	9 1/2'	\$6 <sup>42</sup> EA ★
2548XXXX	16'	\$7 <sup>42</sup> EA ★



## HANDLELESS JUMP ROPES

- Nylon braided ropes turn in your hand without handles
- The danger of injury from a hard plastic handle is eliminated
- Each set includes 1 of each color: **Blue, Green, Orange, Purple, Red and Yellow**

1172522	6'	\$17 <sup>22</sup> SET OF 6 ★
1172539	7'	\$18 <sup>22</sup> SET OF 6 ★
1172546	8'	\$19 <sup>22</sup> SET OF 6 ★
1172553	9'	\$20 <sup>22</sup> SET OF 6 ★
1172560	10'	\$21 <sup>22</sup> SET OF 6 ★
	16'	\$32 <sup>22</sup> SET OF 6 ★

## LEATHER JUMP ROPE

- Ball bearing swivel and foam handles
- 9 1/2' long

2549XXXX	\$17 <sup>22</sup> EA ★
----------	-------------------------

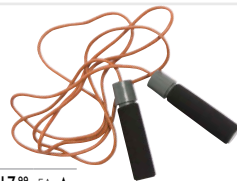

## JUMP ROPE/HOOP RACK

- Stores and transports over 120 jump ropes (up to 10' long) plus hoops
- Large base for increased stability
- Bar heights of 56", 62" and 68" allow children and adults to easily access the correct size jump rope
- Easily goes through standard doorway



1188325	68"H x 27"L x 19"D	\$169 <sup>22</sup> EA
---------	--------------------	------------------------

### JUMP ROPE TIP!

Use the following guidelines when selecting jump ropes for your students

- 6' - UP TO 4' 5" TALL
- 7' - 4' 5" TO 4' 10" TALL
- 8' - 4' 10" TO 5' 3" TALL
- 9' - 5' 4" TO 5' 10" TALL
- 10' - 5' 11" TALL AND OVER



## SPEED ROPES

- Poly rope with plastic swivel handle
- Speed, durability, and flexibility all in one rope

1040043	6'	\$2 <sup>22</sup> EA ★
1040050	7'	\$2 <sup>42</sup> EA ★
1040067	8'	\$2 <sup>62</sup> EA ★
1040074	9'	\$2 <sup>72</sup> EA ★
1040081	10'	\$2 <sup>92</sup> EA ★
1040098	16'	\$3 <sup>82</sup> EA ★



## NEON SPEED ROPES

- Hot, bright, exciting neon colors
- Poly rope with plastic swivel handle is light, durable and flexible

1700XXXX	7' Pink	\$34 <sup>22</sup> DZN ★
1702XXXX	8' Green	\$37 <sup>22</sup> DZN ★
1701XXXX	9' Purple	\$39 <sup>22</sup> DZN ★



## EX-U-ROPES

- Perfect for beginners or experienced jumpers who want the best
- Great for speed jumping and a favorite with jump teams
- Injection molded handles designed for comfort and free spin
- Durable, plastic rope

17206XXX	Black 6' Licorice	\$3 <sup>22</sup> EA
17207XXX	Orange 7' Licorice	\$3 <sup>82</sup> EA
17208XXX	Red 8' Licorice	\$4 <sup>12</sup> EA
17209XXX	Green 9' Licorice	\$4 <sup>42</sup> EA
17210XXX	Black 10' Licorice	\$4 <sup>82</sup> EA



## WALL MOUNTED JUMP ROPE RACK

- All steel wall-mounted unit features five 10" long pegs for storage
- 25" long unit attaches to wall to save space
- Mounting hardware not included

MSWMJRACBM	\$44 <sup>22</sup> EA ★
------------	-------------------------



## SEGMENTED SKIP ROPES

- Designed for use by all age groups and skill levels
- An economical way to promote mass participation
- Great for a fun, aerobic workout
- Features durable, plastic segments over a solid long-lasting nylon cord

1040142	6' Black/White	\$2 <sup>12</sup> EA ★
1040159	7' Red/White	\$2 <sup>22</sup> EA ★
1040166	8' Blue/White	\$2 <sup>42</sup> EA ★
1040173	9' Red/White/Blue	\$2 <sup>72</sup> EA ★
1040128	10' Red/White	\$3 <sup>22</sup> EA ★
1040180	11' Blue/White	\$4 <sup>02</sup> EA ★
1040135	16' Green/White	\$5 <sup>02</sup> EA ★



## THE KANGA-ROPE™

### BY HEARTBEAT

- Developers of Jump Aerobics™
- Tough colored plastic segments on solid braid cord with spin-free handles
- Choose any two-color combination from these colors: **Black, Royal Blue, Green, Orange, Pink, Purple, Red, Yellow and White**

1610XXXX	7'	\$77 <sup>22</sup> DZN
1611XXXX	8'	\$83 <sup>22</sup> DZN
1612XXXX	9'	\$89 <sup>22</sup> DZN
1613XXXX	10'	\$97 <sup>22</sup> DZN
1614XXXX	14'	\$84 <sup>22</sup> SET OF 6
1615XXXX	16'	\$97 <sup>22</sup> SET OF 6



## DOUBLE-DUTCH JUMP ROPES

- Durable cotton/nylon blend ropes are designed for group jump rope activities
- Lightweight construction reduces risk of injury

1706XXXX	14'	\$17 <sup>22</sup> PR ★
----------	-----	-------------------------



Diller Set

**PICKLE BALL®**

- Fast paced game combining badminton, table tennis and tennis
- Played by 2-4 players on a doubles badminton-sized court (20' x 44") indoors or out using wood paddles and a plastic baseball
- Play consists of all the shots and ground strokes similar to tennis
- Lower your badminton net to 3' and start playing
- Perfect game to teach students lead-up skills for all racquet sports
- Set includes 4 wooden paddles, 6 balls, heavy-duty net and rules
- Standards not included

I024XXXX	Diller Set	\$199 <sup>22</sup> SET
I025XXXX	Master Set - Larger, Tapered Paddles	\$249 <sup>22</sup> SET

**TOURNAMENT SET**

- Portable set that can be set up in your gym or on the playground in minutes
- Set includes metal pole standards with net, 4 diller paddles and 6 balls

**90 Day Limited Warranty**

I364661		\$259 <sup>22</sup> SET
---------	--	-------------------------

**PICKLE BALL® ACCESSORIES**

MSPBRDLX	Budget Wood Paddle with Holes	\$16 <sup>42</sup> EA ★
I052XXXX	Replacement Diller Paddle	\$31 <sup>22</sup> EA
I049XXXX	Replacement Master Paddle	\$42 <sup>22</sup> EA
I384931	Graphite Paddle - Specify Blue, Black, Green or Red	\$89 <sup>22</sup> EA
I050XXXX	Outdoor Ball - Specify Orange, White or Yellow	\$36 <sup>22</sup> DZN
I384886	Indoor Ball - Yellow	\$19 <sup>22</sup> DZN



Tournament Set



**PICKLEBALL NET**

- Official pickleball height (34") and width (22') net
- Portable, powder-coated steel frame net system
- Center-strap design for consistent height
- Adjustment straps on net edge for excellent net tension
- Fast and easy assembly, with nylon storage bag

I363633		\$179 <sup>22</sup> EA
---------	--	------------------------



With extenders



Without extenders

**USE IN YOUR 10 & UNDER TENNIS PROGRAM!**

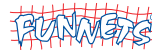

**PORTABLE NET SYSTEM**

- Portable net system for a variety of games and activities
- Ideal for beginning tennis, badminton & volleyball
- Height adjustable from 32" to 52"
- Comes complete with carrying case

I282450	10'L Model	\$109 <sup>22</sup> EA ★
I282467	18'L Model	\$129 <sup>22</sup> EA ★



**Maxi Net**



**QUICKSTART MINI AND MAXI NET SYSTEMS**

- Portable net systems for a variety of activities and lead-up games, including tennis, badminton and beginner volleyball
- Nets are easy to set up and take down in 2 minutes or less without tools
- Mini Net is constructed of durable round metal tubing and adjusts from 30" - 52" high
- Maxi Net is constructed of durable oval metal tubing and adjusts from 30" to 64" high
- Comes complete with carrying case

20025187	Mini Net - 10'L (Round Tubing)	\$139 <sup>22</sup> EA
20021837	Maxi Net - 18'L (Oval Tubing)	\$159 <sup>22</sup> EA

**SEE TENNIS SECTION FOR MORE QUICKSTART PRODUCTS!**

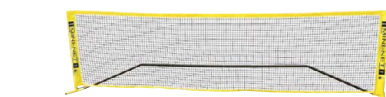

Mini Net

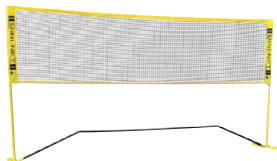

Mini Net with extensions



### HEAVY DUTY SHUFFLEBOARD SET

- Designed for heavy-duty outdoor use
- Cues have regulation 6' tempered aluminum shafts fastened to rugged plastic heads
- 6" high-impact, plastic discs for lively, non-flutter slide
- Set includes 4 cues, 8 discs and instructions

<b>MSSHBSET</b>	Complete Set	\$239 <sup>22</sup> SET
<b>MSSHBRUN</b>	8 Replacement Runners	\$24 <sup>22</sup> SET OF 8
<b>MSSHBDIS</b>	8 Replacement Discs	\$109 <sup>22</sup> SET OF 8
<b>MSSHBRPH</b>	Replacement Heads	\$23 <sup>22</sup> EA



**NEW!**

### RAMPSHOT

- Designed by a Physical Education teacher as an alternative to traditional tossing games, which only allow one player to be active at a time
- Three out of four player players are involved in every play in RampShot which allows for increased physical activity and player engagement
- A highly interactive game that develops motor skills, hand-eye coordination, teamwork and good old fashion fun
- Allows players to toss for points plus catch for points
- Ramps stack inside one another for easy storage and transportation

1388859 \$69<sup>22</sup> EA



### DELUXE CROQUET SET

- Includes 6 solid wood mallets (24" x 7"), 6 color-coded knurled balls (2 3/4" dia.), 9 weather-resistant wickets, 2 goal stakes and a carry case

1152043 \$89<sup>22</sup> SET ★



### TOURNAMENT BOCCÉ SET

- Indoor/outdoor bowling game promotes hand-eye coordination
- Solid, one-piece, composition resin, striped, precision balls
- Official ball of the United States Bocce Federation
- Features 8 bocce balls (107mm) and 1 jack ball (57mm)
- Includes rule book, instructions for court layout and zippered tote bag
- For all age groups

MSUS1602 \$191<sup>22</sup> SET

### ECONOMY BOCCÉ SET

- Perfect for kids and beginner players
- Includes 8 synthetic 4" dia. balls (2 each Blue, Green, Purple, and Yellow) and 1 jack ball

7221XXXX \$59<sup>22</sup> SET ★



### ST. PIERRE® OFFICIAL HORSESHOES

- Official size and weight shoes - NHPA approved
- Includes four 2 lb. 8 oz. solid steel drop forged shoes, 2 solid steel 24"L regulation stakes and rules

3219XXXX \$59<sup>22</sup> SET



### INDOOR/OUTDOOR HORSESHOES

- Includes four 9 oz. hard plastic shoes, two 12" rubber mats with two plastic 6" pegs for indoors and two 16" outdoor plastic stakes

MSSH0EIOY \$29<sup>22</sup> SET ★

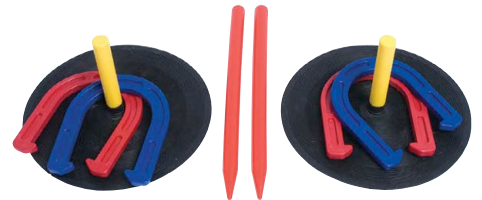

### WASHER TOSS GAME

- Similar to horseshoes, players toss coated metal washers at the bulls eye target
- Score points for hitting the center bulls eye cup and for landing it in the box but not in the cup
- Portable game can be set up for different skill levels
- Includes 2 wooden boxes and 8 washers

1268874 \$52<sup>22</sup> SET ★

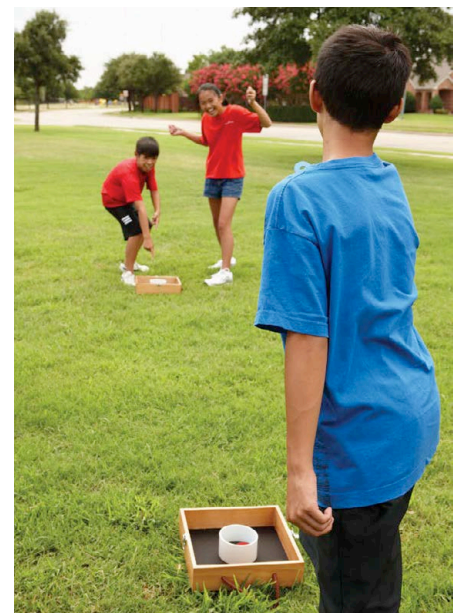



### Disc Golf DISCATCHER®

- Galvanized steel construction with HD welds
- 28 chain grid design
- Powder coated stainless steel chain rack with vinyl numbers
- Anti-skip basket rim prevents skips

MDCI	In-Ground/Permanent	\$599 <sup>99</sup> EA
MDCP	Portable w/Base	\$599 <sup>99</sup> EA

### PORTABLE ECONOMY DISCATCHER®

- Same specs as above units except 18 single chain design with electroplate galvanized finish
- Portable model that can be locked down
- Not meant for permanent outdoor installation

20029345	\$259 <sup>99</sup> EA
----------	------------------------

### ULTIMATE FRISBEE® DISC

- Meets the specifications for the sport of Ultimate
  - UPA approved - 175 grams and 10 1/2" diameter
  - Colors and graphics may vary
- 30 Day Limited Warranty**

<b>1268942</b>	\$13 <sup>99</sup> EA
----------------	-----------------------



### MACH LITE PORTABLE PRACTICE TARGET

- Lightweight (26 lbs.), portable and compact with folding upper chain assembly, basket assembly and base
  - Sturdy steel frame with 16 heavy-duty chains
  - PDGA approved
  - Not designed to be left outdoors
  - Includes carry bag and game instructions
- Color Options: **Black, Blue.**

1390389	Specify Color	\$189 <sup>99</sup> EA
---------	---------------	------------------------



### DISC GOLF SCHOOL PACK

- Includes 12 each drivers, mid-range and putters
- Store in the mesh bag included

<b>1304176</b>	\$199 <sup>99</sup> SET OF 36
----------------	-------------------------------

### TRAVELERS DISCATCHER® TARGET

- Lightweight, portable target pops open in seconds
- Chain and mesh fabric catching area
- Features a wide sturdy base, anchor rings and stakes for increased stability
- Includes bag for storing and transporting
- 50"H x 22"W x 22"L (colors may vary)

1246056	Single Target	\$169 <sup>99</sup> EA
1246063	9 Target Course	\$1,329 <sup>99</sup> SET OF 9 <b>SALE</b>



### COMPETITION DISCS

- Top of the line flying discs for sports games
- Available in 3 different weights, each offering individual features for distance, loft, and freestyle throwing

<b>MSDIS120Y</b>	120g Neon Pink	\$6 <sup>99</sup> EA ★
<b>MSDIS140Y</b>	140g Neon Orange	\$7 <sup>49</sup> EA ★
<b>MSDIS165Y</b>	165g Neon Yellow	\$7 <sup>99</sup> EA ★



### PLASTIC FLYING DISCS

- More fun for the money than any other game
- Each set includes 1 of each color: **Blue, Green, Orange, Purple, Red and Yellow**

<b>1201550</b>	9" Diameter	\$13 <sup>99</sup> SET OF 6 ★
----------------	-------------	-------------------------------

### SPIKEBALL

- A fun, aerobic game that is played 2 on 2
- It's sort of a funky combo of four square and volleyball
- A taut hoop-sized net is placed at ankle level between a pair of two-player teams
- You smack the palm-sized ball down on the net so it ricochets up at your opponents
- They have up to three hits between them (just like volleyball) to control it and bounce it back to you
- When they miss, you score
- Includes 1 net and frame with 3 balls

### 90 Day Limited Warranty

<b>1376884</b>	Combo Set	\$59 <sup>99</sup> SET
<b>1376885</b>	2 Replacement Balls	\$8 <sup>99</sup> SET





## BAGGO BEAN BAG TOSS GAME

- Played similar to horseshoes
- Weighs only 20 lbs. and folds making it easy to carry and store (2 1/2"H x 20"W x 36"L)
- Constructed of high-impact polyethylene for lasting durability
- Take the two boards, spread them apart and begin to play
- Includes 2 game boards, eight 6" bean bags, a distance regulator, wall mounting bracket, and instruction booklet

1269000		\$119 <sup>22</sup>	SET
1269017	Replacement Bean Bags - 4 Red + 4 Blue	\$27 <sup>22</sup>	SET OF 6



## 5" NYLON BEAN BAGS

- Nylon bags are filled with synthetic filler
- Please specify one color per dozen or purchase a prism pack which includes 2 of each color
- Color Options: **Blue, Green, Orange, Purple, Red, Yellow.**

1039900	Specify Color	\$15 <sup>22</sup>	DZN ★
1293418	Prism Pack	\$15 <sup>22</sup>	DZN ★



## WHAMO FRISBEE® DISCS

- The original Frisbee®
- 3 weights and diameters to choose from
- Colors and graphics may vary

1308815	9 3/4" Diameter - 140 Grams	\$8 <sup>22</sup>	EA
1308822	10 1/4" Diameter - 160 Grams	\$11 <sup>22</sup>	EA
1308839	11" Diameter - 200 Grams	\$13 <sup>22</sup>	EA



## FOAM HOOP HOLDERS

- Create your own games by sliding hoops or wands on horizontally and vertically
- Create dozens of over, under and through obstacles
- Use with our standard, deluxe and premium hoops
- Each set includes 1 pair of each color: **Blue, Green, Orange, Purple, Red and Yellow**

1812XXXX \$39<sup>22</sup> SET OF 6 PAIR



## SAFETY GUARD SCOOTERS

### AVAILABLE IN 6 COLORS!

- 12"L x 12"W x 1" thick heavy-duty plastic boards
- Feature safety hand guards with non-marring, double ball-bearing swivel casters

Color Options: **Blue, Green, Orange, Purple, Red, Yellow.**

GCSC12	Specify Color	\$22 <sup>22</sup>	EA ★
1092493	Prism Pack	\$129 <sup>22</sup>	PACK OF 6 ★
1389167	Replacement Wheels	\$6 <sup>22</sup>	SET OF 4 ★



## ZOOMER SCOOTERZ

- 16" x 16" scooters with safety guards to protect hands and fingers
- Feature large 4", durable all-terrain, ball bearing wheels
- Tough enough for the playground but will not harm gym floors
- Each set includes 1 of each color: **Blue, Green, Orange, Purple, Red and Yellow**

1265293	Prism Pack	\$329 <sup>22</sup>	SET OF 6 ★
1296082	Blue	\$57 <sup>22</sup>	EA ★
1389168	Replacement Wheels	\$25 <sup>22</sup>	SET OF 4 ★



## STANDARD HOOPS

- No P.E. or recreation program is complete without hoops
- Versatile hoops teach balance, coordination and rhythm
- Use as targets, jump and hop rings for races and much more
- Each dozen includes 2 of each color: **Blue, Green, Orange, Purple, Red and Yellow**

1246087	24" Diameter	\$37 <sup>22</sup>	DZN
1246070	30" Diameter	\$41 <sup>22</sup>	DZN
1274646	36" Diameter	\$45 <sup>22</sup>	DZN

## DELUXE HOOPS

- Stronger than our standard hoops - thicker wall
- Set them up as targets for tossing, jump and hop rings for races or in your obstacle course
- Set of 12 includes 2 of each color: **Blue, Green, Orange, Purple, Red and Yellow**

1064902	24" Diameter	\$57 <sup>22</sup>	DZN
1064919	30" Diameter	\$62 <sup>22</sup>	DZN
1064926	36" Diameter	\$67 <sup>22</sup>	DZN



## PREMIUM NO-KINK® HOOPS

- Regular hoops often become the object of tug-of-war
- Pulling causes a kink, and off to the hoop graveyard!
- Extra thick walls prevent kinking
- Includes 2 of each color: **Blue, Green, Orange, Purple, Red and Yellow**

02150XXX	24" Diameter	\$59 <sup>22</sup>	DZN
02160XXX	30" Diameter	\$64 <sup>22</sup>	DZN
02170XXX	36" Diameter	\$68 <sup>22</sup>	DZN



**YOUTH LACROSSE STICK**

- Aluminum shaft, wide plastic head with nylon mesh pocket
- 40" overall length makes this the ideal stick for the beginner or youth player

Color Options: **Blue, Red.**

**1363676** Specify Color \$18<sup>22</sup> EA ★



**TRAINING SET**

- Play indoors or out with a safer, modern stick
- Sticks feature plastic pockets and exclusive ball "keeper" straps
- Sticks are lightweight, flexible, durable and will not harm gym floors
- Includes: (12) 36" sticks, 6 orange balls, rule book and lesson plans



1010XXXX	Blue & Red Set	\$249 <sup>22</sup> SET
1011XXXX	Yellow & Green Set	\$249 <sup>22</sup> SET
1012XXXX	Sticks Only - Specify 1 Color	\$129 <sup>22</sup> SET OF 6



**FUN-AIR SCOOP BALL**

- Helps to develop hand-eye coordination
- Use as a lead-up to lacrosse activities
- Complete set of two throwing scoops and a softball sized fun ball

<b>1040104</b>	Green and Pink	\$9 <sup>22</sup> SET ★
<b>1270402</b>	Prism Pack	\$49 <sup>22</sup> SET OF 6 ★



**POLYBAT**

- 29 1/2" long bat weighs 7 oz. - hollow with taped grip

**MSCOS705** \$7<sup>22</sup> EA ★



**PLASTIC TRAINING BALLS**

- Designed for true slow and limited flight

<b>1033601</b>	9" Baseball	\$8 <sup>22</sup> SET OF 6 ★
<b>1033618</b>	12" Softball	\$9 <sup>22</sup> SET OF 6 ★
<b>1141245</b>	Wiffle™ 9" Baseball	\$1 <sup>22</sup> EA
<b>3193XXXX</b>	32" Wiffle® Bat	\$3 <sup>22</sup> EA



**NEW!**

**deBeer DEBEER CLINCHER® SOFTBALL**

- Trutech leather cover
  - Kapok core
  - Unique Clincher® hidden stitching
  - Great for use on hard surfaces
- 30 Day Limited Warranty**

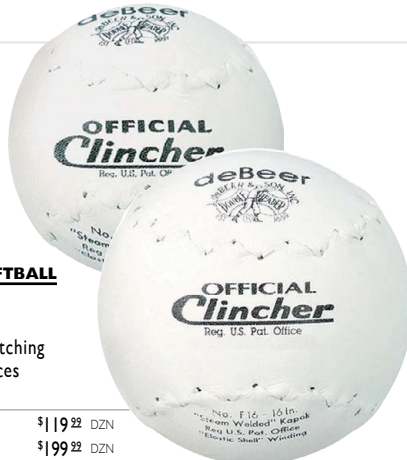

1388860	12"	\$119 <sup>22</sup> DZN
1388861	16"	\$199 <sup>22</sup> DZN

**Voit**

**SPONGE CENTER SOFTBALL**

- Very soft rubber cover
- Cotton surface windings

**VSBC8125** 12" White \$4<sup>22</sup> EA ★



**BLASTBALL™**

- The fun, exciting alternative to traditional T-Ball because of the exclusive "Honking" base
- Easy to learn, fast paced game keeps all of the players involved and "on their toes" at all times
- A great way to help kids develop all their baseball/softball skills
- Everything you need is included in the set: Honking BlastBase™, BlastBat™, BlastBalls™, BlastTee™, Distance Marker and Foul Cone

**20013395** Complete Set \$119<sup>22</sup> SET

**EXTRA BLASTBALL™ EQUIPMENT**

<b>33955XXX</b>	BlastBase™	\$84 <sup>22</sup> EA
<b>FF1861XXXX</b>	BlastTee™	\$24 <sup>22</sup> EA
<b>33956XXX</b>	Two BlastBalls™	\$8 <sup>22</sup> PACK OF 2
<b>1040227</b>	Foam Bat	\$13 <sup>22</sup> EA ★
<b>33957XXX</b>	Distance Marker	\$4 <sup>22</sup> EA
<b>189BLAST</b>	Foul Cone	\$3 <sup>22</sup> EA



**ARE YOU HAVING TROUBLE GETTING YOUR YOUNGER STUDENTS AND PLAYERS EXCITED ABOUT PLAYING BASEBALL OR T-BALL? IF SO, THEN BLASTBALL® IS WHAT YOU NEED!**



## Voitt TETHERBALLS

- Both balls feature nylon windings and a butyl bladder for added shape and air retention
- Choose between a soft touch cover for added comfort or a traditional rubber cover
- Includes an attached recessed rope

1. <b>VCT850HS</b>	Soft Touch Cover	\$17 <sup>99</sup> EA ★
2. <b>VCT850HX</b>	Rubber Cover	\$15 <sup>99</sup> EA ★



## SSTB Sof-T™ TETHERBALL

- Manufactured with a special rubber composition cover
- Provides a softer play and feel
- Includes a nylon rope with metal clip

3. <b>TACSSTBX</b>		\$19 <sup>99</sup> EA
--------------------	--	-----------------------



## PORTABLE TETHERBALL STANDARD

- 40" dia. steel base with a non-marring rubber edge
- Rolls indoors or outdoors
- 10'H pole is 1.9" OD galvanized steel tube with a permanent top eye
- **Ball included**

<b>THBPORT</b>	\$429 <sup>99</sup> EA ★	
----------------	--------------------------	--

## OUTDOOR TETHERBALL POLE

- 12'L (2 pieces 6'L) 2 3/8" galvanized steel post installs permanently into the ground 2'
- Permanent top eye and ball included

<b>THBIG</b>	\$149 <sup>99</sup> EA ★
--------------	--------------------------

## TETHERBALL POLE GROUND SLEEVE

- For semi permanent installation of our outdoor pole

<b>STTBGSXX</b>	\$44 <sup>99</sup> EA ★
-----------------	-------------------------



## RUBBER BUCKET SWING CHAIR

- Soft, all-weather safety seat for toddlers
- Safety chain included
- For ages 2-4

<b>1040746</b>	\$59 <sup>99</sup> EA ★
----------------	-------------------------

## 360° ENCLOSED SWING SEAT

- Heavy-duty, rubber enclosed seat for infants
- For ages 2-4

<b>1040685</b>	\$89 <sup>99</sup> EA ★
----------------	-------------------------



## 6" SLASHPROOF SWING SEAT

- Synthetic rubber seat with a metal insert for increased durability
- For ages 5-12

<b>6152DXXX</b>	\$29 <sup>99</sup> EA ★
-----------------	-------------------------

## SWING HANGERS - GALVANIZED STEEL

<b>1041194</b>	For 3 1/2" OD Pipe	\$50 <sup>99</sup> EA
<b>1041200</b>	For 2 3/8" OD Pipe	\$40 <sup>99</sup> EA

## REPLACEMENT SWING SET PARTS

<b>1041217</b>	3/8" Galvanized Large S-Hook	\$1 <sup>99</sup> EA ★
<b>1041354</b>	4/0 Heavy Duty Galvanized Chain (Specify Length)	\$4 <sup>99</sup> FT ★



## JUGGLING SCARVES

- Teach juggling fundamentals with these 15" square, nylon scarves
- Beginners enjoy early success with these scarves that float through air
- Engages children with poor concentration
- Includes 2 of each color: **Blue, Green, Orange, Purple, Red and Yellow**

<b>1206258</b>	\$15 <sup>99</sup> DZN ★
<b>1041057</b>	School Pack of 108 \$89 <sup>99</sup> PACK OF 108 ★



## CLASSIC POTATO SACKS

- Large heavy duty burlap bags
- Great for field day activity
- Incorporates core strength and locomotor skills in children of all abilities
- Approximately 34"H x 20"W

<b>1378733</b>	\$54 <sup>99</sup> DZN ★
----------------	--------------------------



## BLONGOBALL

- Physical education and classroom teachers can use this game to teach math, literature and hand-eye coordination to kids of all ages and abilities
- Players take turns tossing the Blongoballs at the opposite goal trying to wrap them on one of the three bars
- Each bar scores different points while points are subtracted when a players balls are knocked off by their opponent
- Set includes 2 goals (2'W x 3'H), 2 sets of 3 outdoor balls and instructions

## 90 Day Limited Warranty

<b>1257021</b>	Complete Game	\$69 <sup>99</sup> SET
----------------	---------------	------------------------

## Replacement Blongoballs

Color Options: **Blue, Green, Red.**

<b>1257038</b>	Hard - Outdoors	\$13 <sup>99</sup> SET OF 3
<b>1257069</b>	Soft - Indoors	\$11 <sup>99</sup> SET OF 3

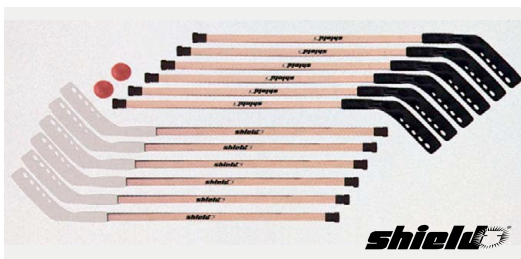

### OUTDOOR HOCKEY SETS (GRADES 9+)

- Extra thick reinforced plastic blades
- Available with wood or aluminum shafts
- Includes 12 sticks, 2 speed control balls and instruction booklet

10740XXX	#740 Pro Wood Set (56" Sticks)	\$219 <sup>22</sup> EA
20026521	#730 Aluminum Set (53" Sticks)	\$349 <sup>22</sup> SET
2002745	Replacement Wood Stick, Black or White	\$24 <sup>22</sup> EA
2002735	Replacement Alum. Stick, Black or White	\$32 <sup>22</sup> EA
896WHXXX	Replacement Blade - Black or White	\$15 <sup>22</sup> SET



### PROTECTIVE GOGGLES

- Made of hard polycarbonate — impact resistant
- Fits comfortably over glasses

PAA728XX \$9<sup>22</sup> EA

### HELMET WITH WIRE FACE CAGE

FEATURES THE EASY FIT "SLIDE" ADJUSTMENT SYSTEM!

- These lightweight helmets come with a heavy-duty wire cage and foam chin cup for a comfortable fit
- Model #0151 features 1/2" foam padding
- Model #0152 has 3/4" foam and a smaller cage for a secure fit for younger players
- Please specify color

Color Options: **Black, White.**



0151	Hat Size 7 1/4" - 8 1/3"	\$49 <sup>22</sup> EA
0152	Hat Size 6 3/4" - 7 3/4"	\$49 <sup>22</sup> EA



### HELMETS

- Features an easy to fit "slide" adjustment system
- Lightweight and durable outer shell with 1/2" foam padding
- Available in **Royal, Scarlet, Black and White**
- Please specify one color per set

0150XXXX \$109<sup>22</sup> SET OF 4

### GOALIE EQUIPMENT

#### CATCH GLOVES

- Specify Right or Left handed player

0540XXXX	Jr.	\$64 <sup>22</sup> EA
0560XXXX	Sr.	\$84 <sup>22</sup> EA

#### BLOCKERS

- Specify Right or Left handed player

0520XXXX	Jr. - 15" x 8 1/4"	\$52 <sup>22</sup> EA
0530XXXX	Sr. - 16" x 9"	\$66 <sup>22</sup> EA

#### 1. ULTRA PRO II GOALIE MASK

- Molded high impact ultra lightweight plastic vented shell with chrome colored cage
- Full adjustable back plate and elastic straps with snaps
- Not intended for ice hockey or hard puck play

1135756	White	\$99 <sup>22</sup> PR
1342772	Black	\$99 <sup>22</sup> PR
1135763	Patriot	\$99 <sup>22</sup> PR

#### 2. PRO GOALIE MASK

- Traditional wrap-around design and back skull plate with adjustable straps
- Designed for street and floor hockey

Color Options: **Black, White.**

1038XXXX \$26<sup>22</sup> EA

#### GOALIE PADS

- Specify **Black or White**

0172XXXX	Small 22"	\$72 <sup>22</sup> PR
0171XXXX	Medium 27"	\$74 <sup>22</sup> PR
0170XXXX	Large 32"	\$79 <sup>22</sup> PR

#### AIR-FLO HOCKEY CHEST PROTECTOR

PROTECTS CHEST AND COMPLETE ARMS!

- Lightweight, breathable 1/2" foam padding with a ventilated mesh outer shell
- Features reinforced nylon binding, adjustable elastic strap with buckle and full arm protection

Jr. shown

20020189	Junior	\$70 <sup>22</sup> EA
1363639	Senior	\$73 <sup>22</sup> EA

### TUFF PUCK

- Extra-tough, one-piece, soft PVC puck

1040944 \$9<sup>22</sup> SET OF 3 ★



### US Games

### TUFF BALL

#### EXTRA HEAVY-DUTY WALLS!

- A one-piece, roto-molded, soft PVC hockey ball
- 2 3/4" diameter

1040234 \$6<sup>22</sup> SET OF 3 ★



### SUPERSAFE® PUCK

- Slides flat against the floor - reduces puck flip
- 4" dia. soft, spongy construction - colors may vary

1139822 \$5<sup>22</sup> EA



### Shield

### ORANGE No-BOUNCE HOTBALL

- One-piece, seamless, vinyl ball

1058XXXX 2.5/8" Diameter \$10<sup>22</sup> SET OF 3



### FELT PUCK

- Felt filled and leather wrapped - moves effortlessly across a gym floor
- Simulates the speed of an ice hockey puck

1272871 \$10<sup>22</sup> EA



### Shield

### SPEED CONTROL BALLS

- This 3" soft, over-sized plastic ball travels straight and true, slower than a ball and faster than a plastic puck

1135718 \$38<sup>22</sup> DZN







## Shield 47" ALUMINATOR® HOCKEY SET

- Strong aluminum shafts and reinforced plastic blades
- Great grip improves stick handling
- Includes: 12 sticks, 2 hotballs, 2 soft shot pucks, 2 replacement blades and instructions

1057XXX	47" Stick Set	\$319 <sup>99</sup> SET
8853	Replacement 47" Aluminum Stick, Red or Blue	\$32 <sup>99</sup> EA
894	Replacement Blades Red or Blue	\$14 <sup>99</sup> SET OF 3
20026517	40" Goalie Stick, Aluminum Shaft	\$26 <sup>99</sup> EA



## 43" SENIOR FLOOR HOCKEY SET

### SENIOR SET SHOWN

- Extra strong, plastic shafts and blades
- Includes 12 sticks (6 each **Blue** and **Yellow**), 2 plastic goalie sticks, 2 pucks and 2 balls

MSHOCKSRY	43" Stick Set	\$159 <sup>99</sup> SET ★
1151015	43" Replacement Sticks - Blue or Yellow	\$37 <sup>99</sup> SET OF 3 ★
MSFHSRBBY	Replacement Blades - Blue or Yellow	\$14 <sup>99</sup> SET OF 3 ★

## 36" JUNIOR FLOOR HOCKEY SET

- Durable, plastic shafts and blades
- Includes 12 sticks (6 each **Red** and **Yellow**) and 3 pucks

MSHOCKJRY	36" Stick Set	\$99 <sup>99</sup> SET ★
1150995	36" Replacement Sticks - Red or Yellow	\$27 <sup>99</sup> SET OF 3 ★
1040869	Replacement Blades - Red or Yellow	\$13 <sup>99</sup> SET OF 3 ★

## Shield 42" DELUXE HOCKEY SET

- Patented ABS plastic shafts with reinforced plastic blades
- Includes: 12 sticks, 2 all plastic goalie sticks, 2 hotballs, 2 soft shot pucks, 2 replacement blades and instructions

1053XXXX	42" Stick Set	\$219 <sup>99</sup> SET
----------	---------------	-------------------------

## 42" BASIC HOCKEY SET

- Patented ABS plastic shafts with reinforced plastic blades
- Includes: 12 sticks, 1 hotball, 1 soft shot puck and instructions

1053BXXX	42" Stick Set	\$179 <sup>99</sup> SET
1055	Replacement Sticks, Red or Blue	\$18 <sup>99</sup> EA
20026520	Replacement Shafts	\$37 <sup>99</sup> SET OF 3
894	Replacement Blades Red or Blue	\$14 <sup>99</sup> SET OF 3
1057XXXX	G goalie Stick, Plastic Shaft	\$26 <sup>99</sup> EA

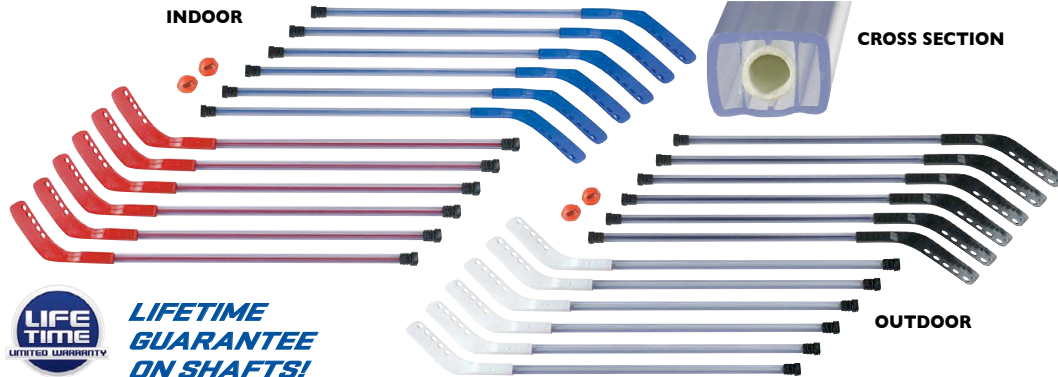

## Shield LTG 42" MIDDLE SCHOOL HOCKEY SETS

- LTG shafts guaranteed for life!
- Tough, clear, plastic shaft with a lightweight, hollow, fiberglass, tube
- Set includes: 12 LTG sticks, 2 speed control balls and instructions
- Indoor sticks have red and blue blades
- Outdoor sticks have black and white blades
- Made in the USA

1249637	Indoor	\$289 <sup>99</sup> SET
1249644	Outdoor	\$309 <sup>99</sup> SET



## Shield LTG 50" HIGH SCHOOL/COLLEGIATE HOCKEY SETS

- LTG shafts guaranteed for life!
- Tough, black, plastic shaft with a lightweight, solid, fiberglass, rod
- Set includes: 10 LTG sticks, 2 ABS goalie sticks, 2 speed control balls and instructions
- Indoor sticks have red and blue blades
- Outdoor sticks have black and white blades
- Made in the USA

1304213	Indoor Set	\$229 <sup>99</sup> SET
1304220	Outdoor Set	\$239 <sup>99</sup> SET





**FOLDING SPORTS GOAL**

- High impact, 1 5/8" PVC tubing with center pipe support for added strength
- Features a "sleeve" netting system that slides on easily
- Quick and easy assembly - folds for storage
- 44"H x 54"W x 24"D

<b>1065336</b>		\$49 <sup>99</sup> EA
<b>1304855</b>	Replacement Net	\$25 <sup>99</sup> EA



**FOLDING ALL PURPOSE GOAL**

- 1 5/8" high-impact PVC frame
- Push-button Loc fittings for easy folding and storage
- Bungee Slip-Net with 1-1/2" mesh size for quick set-up
- Double back support bars for stability
- Includes ground anchors for outdoor use
- 48"H x 72"W x 36"D

<b>1304763</b>		\$89 <sup>99</sup> EA
<b>1304794</b>	Replacement Net	\$24 <sup>99</sup> EA



**ALL PURPOSE STEEL GOAL**

- Heavy gauge 1 1/4" steel tubing with center pipe support
- Features the sleeve netting system
- Pro style design with top shelf
- Assembly required - non folding
- 43"H x 52"W x 28"D

<b>1256208</b>		\$63 <sup>99</sup> EA
<b>1304855</b>	Replacement Net	\$25 <sup>99</sup> EA



**ULTRA PRO GOAL**

- 1 5/8" PVC tubing with back support bar
- Includes heavy-duty sleeve net
- Pro style design - assembly required
- 44"H x 54"W x 24"D

<b>1304848</b>		\$72 <sup>99</sup> EA
<b>1304855</b>	Replacement Net	\$25 <sup>99</sup> EA



**FOLDING STEEL HOCKEY GOAL**

- Durable, 1 1/2" diameter, 18 gauge, steel frame
- Bungee slip net with clamps for easy attachment and adjustment
- Includes anchors for outdoor use on grass
- 44"H x 54"W x 30" D

<b>1343113</b>		\$99 <sup>99</sup> EA
<b>1388262</b>	Replacement Net	\$19 <sup>99</sup> EA



**MULTI-PURPOSE EQUIPMENT CART**

- Constructed of 1" powder coated steel tubing
- Great for carrying PE and baseball equipment
- Polyester bag measures 24"W x 24"W x 12"D

<b>1197655</b>	46"H x 29"W x 30"D - 29 lbs.	\$199 <sup>99</sup> EA ★
----------------	------------------------------	--------------------------



**SOCCER/HOCKEY GOAL - ABS**

- 4' x 6' goal to be used indoors or outdoors for soccer, hockey, floor hockey or many other uses.
- 3mm net with nylon sleeves
- 1 5/8" O.D. Sportstuff rods and assembled with ABS fittings
- Weight: 18 lbs.

<b>FH046D</b>	4'H x 6'W x 18"D	\$179 <sup>99</sup> EA ★
<b>1162400</b>	Replacement Net	\$64 <sup>99</sup> EA ★



**SOCCER/HOCKEY GOAL - STEEL**

- 4' x 6' goal to be used indoors or outdoors for soccer, hockey, floor hockey or many other uses
- 3mm net with nylon sleeves
- 1 5/16" O.D. galvanized steel tubing and assembled with galvanized steel fittings; equipped rubber footings for indoor use
- Weight: 44 lbs.

<b>FH046DS</b>	4'H x 6'W x 18"D	\$399 <sup>99</sup> EA ★
<b>1162400</b>	Replacement Net	\$64 <sup>99</sup> EA ★

## THE ORIGINAL PILLO POLO®

### HOW THE GAME IS PLAYED:

- Played similar to ice hockey rules, except the goalie is allowed to pick up the ball and throw it down field
- No. Players: 12 plus substitutes
- Age Levels: 7 years and up
- Space Required: 50' x 100'
- Supervision Required: 1 Referee
- Average Activity Time: 30 - 60 min.
- Sticks are lightweight yet durable - tough outer skin over urethane foam heads that resist peeling and flexible plastic shafts

### HIGH PERFORMANCE STICKS. MADE OF SOFT DURABLE FOAM!

#### Complete Pillo Polo® Game

- 6 **Blue** and 6 **Yellow** sticks 31" long, two 7" foam balls, set of official rules
- Goals, cones and bag not included

**1041170**

 \$149<sup>99</sup> SET ★

#### Double Pillo Polo® Game

- 12 **Blue** and 12 **Yellow** sticks 31" long, four 7" foam balls, set of official rules
- Goals, cones and bag not included

**2600XXXX**

 \$269<sup>99</sup> PACK ★

## ACCESSORIES

### Extra Pillo Polo® Sticks

Specify Blue or Yellow

**601XXXXX**

 \$15<sup>99</sup> EA ★

### 6" Game Cones

 Color Options: **Blue, Orange, Purple, Red, Yellow, Green.**
**MSCONE**

 \$4<sup>99</sup> EA ★

### Storage Bag

 Color Options: **Black, Blue, Gold, Kelly, Orange, Purple, Red.**
**SNBCNET**

 \$10<sup>99</sup> EA ★

### Extra 7" Foam Balls

**607XXXXXY**

 \$10<sup>99</sup> EA ★

### Pillo Polo Goal

• 44"H x 54"W x 30"D steel goal

**1343113**

 \$99<sup>99</sup> EA

## PILLO HOCKEY

- Combines floor hockey, polo, field hockey and ice hockey in one safe, soft and easy-to-use game
- Perfect for all ages
- The head is made of soft urethane foam attached to a flexible, hollow, plastic stick with a contoured handle
- Set includes: 5 **Blue** and 5 **Yellow** 36"L sticks, 1 - 7" foam ball, and 1 - 4" puck

**625XXXXX**

Complete Set

 \$149<sup>99</sup> SET ★

**607XXXXXY**

7" Vinyl Coated Foam Ball

 \$10<sup>99</sup> EA ★

## FOAMTUFF POLO SET

- Tough ethafoam heads with durable plastic shafts
- Sticks are 34"L with 9"L x 4" diameter heads
- Set includes 12 sticks and 1 polyurethane foam 6" ball

**1267228**

Complete Set

 \$89<sup>99</sup> SET ★

**1268843**

Red Stick

 \$7<sup>99</sup> EA ★

**1268850**

Yellow Stick

 \$7<sup>99</sup> EA ★

**1268867**

6" Ball

 \$5<sup>99</sup> EA ★

## TOPPLEBALL®

- Requires only a 60' square area to play
- Played in over 10,000 recreation and school systems
- Permits 15-25 players to participate and be involved
- Easy to learn - play indoors or out - for ages 8 and up
- **How The Game is Played:**

- Players form a circle and each takes a turn batting
- Batter with the most runs wins game

- **Batter's Objective:** Get the maximum number of runs before the "Toppleball" is knocked off the batter's post by the playground ball - batter hits the playground ball past the fielders and runs to the edge of the circle and back earning a run
- **Fielder's Objective:** Get the batter out by knocking the "Toppleball" off the post with the playground ball - requires teamwork

**1125924**

Complete Toppleball® Game

 \$179<sup>99</sup> EA ★

**1125931**

Replacement Bat

 \$39<sup>99</sup> EA ★

**INDIVIDUAL CLUBS****Two-Way Putter**

Two-Way Putter-Left or Right Hand

**3099XXXX** 33.5" Long \$19<sup>99</sup> EA**Men's Individual Metal Woods 1-3-5**

3081MXXX	Right Hand	\$35 <sup>99</sup> EA
3083MXXX	Left Hand	\$35 <sup>99</sup> EA

**Men's Individual Irons 3-9 - PW**

3082MXXX	Right Hand	\$25 <sup>99</sup> EA
3084MXXX	Left Hand	\$25 <sup>99</sup> EA

**Women's Individual Irons 3-9-PW**

3082WXXX	Right Hand	\$25 <sup>99</sup> EA
3084WXXX	Left Hand	\$25 <sup>99</sup> EA

**Junior (Ages 10-14) Individual Irons 3,5,7,9,PW**

3086XXXX	Right Hand	\$25 <sup>99</sup> EA
3089XXXX	Left Hand	\$25 <sup>99</sup> EA

**GOLF TEES**

- 2 1/8" wood tees
- White

**60278XXX** \$27<sup>99</sup> BOX OF 500**PRACTICE GOLF BALLS**

- Plastic ball for indoor/outdoor use
- 6 balls per pack

**MSPGBWHT** \$1<sup>99</sup> PACK OF 6 ★**DRIVING RANGE BALLS**

- Perfect for driving ranges
- Brand new - not recycled
- Surlyn cover
- Packed half white, half yellow

20011436	3 dz	\$38 <sup>99</sup> PACK OF 36
20011444	12 dz	\$142 <sup>99</sup> PACK OF 144

**JUNIOR SETS**

- Oversized Ti-Matrix driver (#1) and matching fairway wood (#3)
- Wide sole hybrid (#5)
- Stainless steel irons (#7- #9 - SW)
- Ball alignment putter
- Lightweight stand bag
- For ages 13+

<b>3079XXXX</b>	Right Hand	\$169 <sup>99</sup> SET
<b>3088XXXX</b>	Left Hand	\$169 <sup>99</sup> SET

**PLASTIC PUTTING CUP**

- Improves putting accuracy
- Features positive retention system that holds on-line putts while rejecting gimmies
- Official size hole

**1303926** \$4<sup>99</sup> EA ★**ROUGH CHIPPING MAT**

- Practice short chips out of the rough
- Perfect companion to any chipping target
- Skid resistant foam backing
- Indoor/outdoor use

**1303957** 1' x 2' \$37<sup>99</sup> EA ★**ALMOSTGOLF™ PRACTICE BALL**

- High performance practice ball
  - True ball flight and feel
  - Limited distance (1/3 regulation ball) with accuracy
  - 25% the weight of a regulation ball
  - Use indoors or outdoors
- Color Options: **White, Yellow.**

<b>1309997</b>	3 Dozen Pack	\$47 <sup>99</sup> PACK
<b>1310016</b>	20 Dozen Pack	\$279 <sup>99</sup> PACK ★

**10 PIECE SET****7 PIECE SET****GOLF CLUB SETS**

- Satin finished irons balanced to weight to help maximize the sweet spot
- Oversize titanium alloy woods
- True Temper® shafts with composition grips
- 10 piece sets include 7 irons (4-PW), 2 metal woods (1-3) and one 3/4 combo hybrid
- 7piece sets include 4 irons (5-7-9,PW), 2 metal woods (1-3) & putter

<b>3075RHXX</b>	Men's 10 Piece Right Handed Set	\$164 <sup>99</sup> SET
<b>3075LHXX</b>	Men's 10 Piece Left Handed Set	\$164 <sup>99</sup> SET
<b>3076RHXX</b>	Women's 10 Piece Right Handed Set	\$164 <sup>99</sup> SET

**Men's 7 Piece Right Handed Set**

<b>3077RHXX</b>	Men's 7 Piece Right Handed Set	\$117 <sup>99</sup> SET
<b>3077LHXX</b>	Men's 7 Piece Left Hand Set	\$117 <sup>99</sup> SET

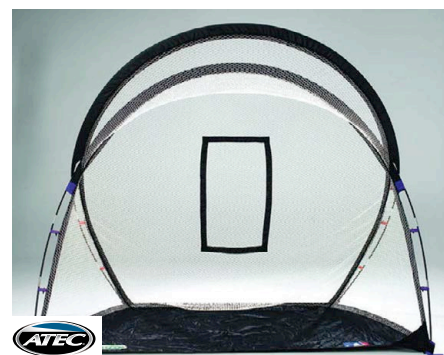
**ACADEMY GOLF NET**

- Dimensions: 88"H x 104"W x 51"D
- Cantilever design with extra large surface area
- Simple, fast assembly and storage
- Rugged, durable net and double stitched floor are weather-resistant for long life
- Includes carry bag

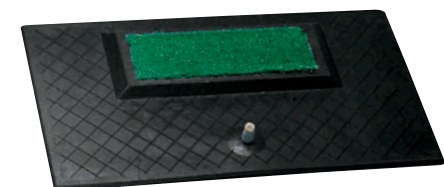
**1033496** \$199<sup>99</sup> EA**CHIP-N-DRIVE MAT**

- 14" x 26" size
- Includes rubber tee

**6113XXXX** \$42<sup>99</sup> EA ★



## ARCHERY STARTER KIT

### PACKAGE INCLUDES:

- (3) foam targets, 36" diameter x 6" thick with 10 ring target face
- (3) tripod target stands
- (3) 60" - 20-29 lb. draw youth bows
- (3) 60" - 30-35 lb. draw youth bows
- (72) 28" Safetyglass vaned arrows
- (6) armguards
- (6) shooting gloves (3 medium and 3 large)
- (3) ground quivers
- (1) archery manual
- (1) storage cart designed specifically to store this entire package

1072549

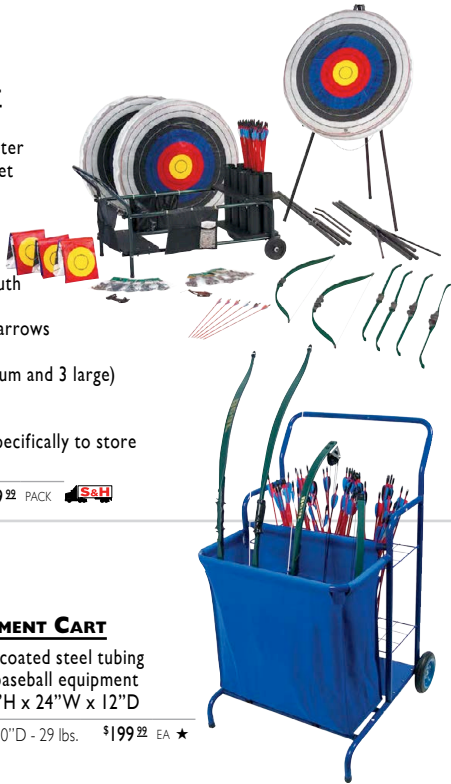
 \$1,899<sup>22</sup> PACK 

## MULTI-PURPOSE EQUIPMENT CART

- Constructed of 1" powder coated steel tubing
- Great for carrying PE and baseball equipment
- Polyester bag measures 24"H x 24"W x 12"D

**1197655**

 46"H x 29"W x 30"D - 29 lbs. \$199<sup>22</sup> EA ★

## SINGLE LOOP BOW STRING

- Recurve bow single loop braided nylon string
- 60" long - Please order in increments of 6 each (6-12-18-etc.)
- Fits most bows up to 40 lbs.

### 30 Day Limited Warranty

1380796

 \$5<sup>22</sup> EA

## DOUBLE LOOP BOW STRINGS

### With Center Serving

- Braided for bows up to 40 lbs.
- **Please specify string length (3 per size)**  
Length: **36", 40", 44", 46", 48", 52", 56", 58", 60"**.

**PAR50**

 \$24<sup>22</sup> PACK OF 3

**NEW!**

## MOCKING JAY YOUTH LONGBOW

- Durable bow made of palm tree wood
- Leather wrap-around grip
- Arrow shelf on both sides for RH and LH shooters
- 58" length with 20-25 lb. draw for recreational shooting
- Bow string included
- For ages 10 - 19 and adults up to 5' 10" with a draw length up to 28"

1387743

 Ages 10 and Up \$69<sup>22</sup> EA

## MONARCH TAKEDOWN BOW

- 62" takedown bow designed for beginners
- Hard wood riser, wood core and fiberglass limbs
- Ready to shoot with arrow rest installed
- Shoots right or left handed
- Available in 20-25-29-35 lb. draw weights

 Hand: **Left, Right**

 Weight: **20 LB, 25 LB, 29 LB, 35 LB.**

1387750

 Specify Hand and Draw Weight \$124<sup>22</sup> EA

## RECURVE BOWS



### SOLID RECURVE BOWS

- Uses durable composite limbs with molded plastic handle
- Used nationwide by camp and school programs
- For left or right hand - bow string included

- |             |   |                       |
|-------------|---|-----------------------|
| 1. 3752XXXX | Bow AMO 44", Draw Wt. 10-18 lbs. (Ages 5 to 10) | \$27 <sup>22</sup> EA |
| 2. 3678XXXX | Bow AMO 51", Draw Wt. 10-20 lbs. (Ages 9+)      | \$37 <sup>22</sup> EA |
| 3. 3751XXXX | Bow AMO 60", Draw Wt. 20-29 lbs. (Ages 10+)     | \$54 <sup>22</sup> EA |
| 4. 3676XXXX | Bow AMO 60", Draw Wt. 30-35 lbs. (Ages 10+)     | \$59 <sup>22</sup> EA |

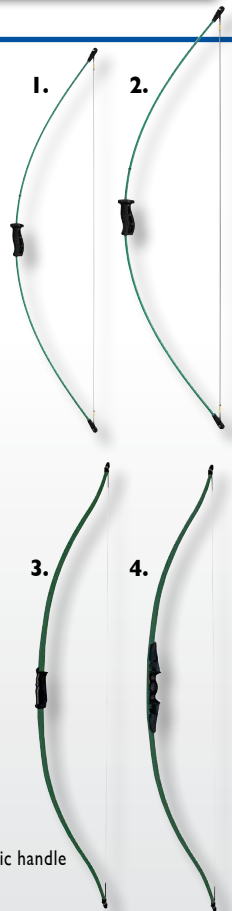

## COMPOUND BOWS



### GENESIS BOWS

- Fiberglass and aluminum bow that is easy to shoot
  - Combines "zero let-off" with light, adjustable 10-20 lb. draw weights that cover all standard draw lengths
  - **Official Bow of the National Archery in the Schools Program**
- Color Options: **Blue, Green, Orange, Purple, Red, Yellow**  
Hand: **Right, Left.**

1255485

 \$199<sup>22</sup> EA

### GENESIS MINI BOW

- Same as the Genesis bow - for younger archers
  - Weighs only 2 lbs. with adjustable draw weights of 6-12 lbs. to cover draw lengths from 14" - 25"
- Color Options: **Black, Blue, Red**  
Hand: **Right, Left.**

1255591

 \$199<sup>22</sup> EA



### FLU-FLU CEDAR ARROWS

- Limited flight, 30" cedar shaft arrow with 3 fletchings
- Rubber blunt tip - spined 45/50 lbs.

**90 Day Limited Warranty**

3765XXXX	18 Pack	\$169 <sup>99</sup>	PACK OF 18
3789XXXX	3 Dz.	\$319 <sup>99</sup>	PACK OF 36

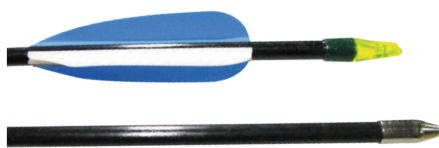

### FIBERGLASS TARGET ARROWS

- Extremely durable, withstands much abuse
  - 3" plastic vanes and steel target point
  - Maximum spine weight 40 lbs.
- Length: **26", 28", 30"**.

20027506	Dz.	\$49 <sup>99</sup>	DZN
20027572	72 Pack	\$289 <sup>99</sup>	PACK OF 72
20027544	Gross	\$499 <sup>99</sup>	GROSS OF 144
1305067	Nocks 17/64"	\$42 <sup>99</sup>	PACK OF 100
1305074	Points 17/64"	\$4 <sup>99</sup>	DOZEN



### EASTON GENESIS ALUMINUM ARROWS

- Tournament approved by the NASP
  - Made from 7075 aerospace alloy
  - 3" vanes with nock and point installed
  - 30" long for bows up to 30 lb. draw weight
- Color Options: **Blue, Orange.**

<b>1380826</b>	Specify Color	\$79 <sup>99</sup>	DZN
----------------	---------------	--------------------	-----

### SELECT WOOD ARROWS

- Select grade arrows with 5/16" wood shafts
  - Features 3" feathers, snap-on nock and crimped steel target point
  - Maximum spine weight 35 lbs.
  - Please specify length
- Length: **26", 28", 30"**.

#### Cedar Shafts - Dozen

20021106	\$69 <sup>99</sup>	DZN
20021172	\$399 <sup>99</sup>	PACK OF 72
20021144	\$759 <sup>99</sup>	GROSS OF 144

#### Poplar Shafts - Dozen

1160123	\$65 <sup>99</sup>	DZN
1160130	\$349 <sup>99</sup>	PACK OF 72
1162950	\$619 <sup>99</sup>	GROSS OF 144



### STANDARD WOOD ARROWS

- Standard grade arrows with 5/16" wood shafts
  - Features PVC vanes, snap-on nock and crimped steel target point
  - Maximum spine weight 35 lbs.
  - Please specify length
- Length: **24", 26", 28"**.

#### Cedar Shafts - Pack of 144

3726XXXX	\$649 <sup>99</sup>	GROSS OF 144
3791XXXX	\$59 <sup>99</sup>	DZN
<b>3732XXXX</b>	\$339 <sup>99</sup>	PACK OF 72 ★

#### Poplar Shafts - Dozen

1160109	\$53 <sup>99</sup>	DZN
1160116	\$299 <sup>99</sup>	PACK OF 72
1162943	\$559 <sup>99</sup>	GROSS OF 144

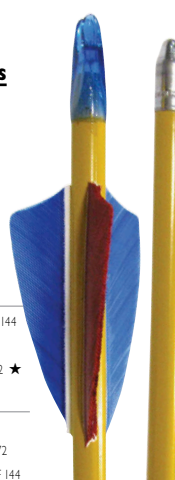

### SAFETYGLASS™ TARGET ARROWS

- Strong, durable, fiberglass arrows that flex and will not splinter
- Includes nock, point and vanes
- Spine weight maximum 29 lbs.

8102XXXX	26"	\$279 <sup>99</sup>	PACK OF 72
8114XXXX	Combo 24 Each 26"-28"-30"	\$279 <sup>99</sup>	PACK OF 72
20020810	28"	\$279 <sup>99</sup>	PACK OF 72
20020811	30"	\$279 <sup>99</sup>	PACK OF 72



### ARCHERY CUSTOM NETTING

#### FOR INDOOR AND OUTDOOR USE!

- Heavy-duty, fine mesh netting for use with bows up to 35 lbs.
- Support nets on guy wires from walls, HD portable standards or in-ground posts - not included
- Netting is bordered with grommets at top and corners
- **Specify Size: 10' standard height - Order 10'H x desired length**

SNARCHEY	\$2 <sup>99</sup>	SQ.FT.
----------	-------------------	--------

### PRE-CUT ARCHERY NETTING

<b>1233810</b>	16'W x 10'H	\$199 <sup>99</sup>	EA
<b>1233827</b>	26'W x 10'H	\$319 <sup>99</sup>	EA
<b>1233834</b>	36'W x 10'H	\$439 <sup>99</sup>	EA
<b>1233841</b>	50'W x 10'H	\$599 <sup>99</sup>	EA

### 6" DELUXE ARMGUARD

- Tough vinyl with 2 straps and hook and loop fasteners
- One size fits all - colors may vary

<b>3759XXXX</b>	\$13 <sup>99</sup>	EA
-----------------	--------------------	----



### 12" DELUXE ARMGUARD

- Tough vinyl with 4 straps and hook and loop fasteners
- One size fits all

<b>3804XXXX</b>	\$14 <sup>99</sup>	EA
-----------------	--------------------	----



**NEW!**

### ECONOMY FINGER TAB

- An inexpensive shooting tab for the beginner
- **One size fits all**

<b>3799XXXXDZ</b>	\$7 <sup>99</sup>	DZN
-------------------	-------------------	-----



### 6" ECONOMY ARMGUARD

- Vinyl leatherette with easy fasten hook for youth programs

<b>3700XXXX</b>	\$4 <sup>99</sup>	EA
-----------------	-------------------	----



### SHOOTING GLOVE

- Durable glove with elastic back and adjustable hook and loop fastening strap
  - Reinforced, closed end finger tips
- Size: **MED, LRG.**

3733	\$9 <sup>99</sup>	EA
------	-------------------	----



### GROUND QUIVER

- All steel - holds 12 arrows

3764XXXX	\$16 <sup>99</sup>	EA
----------	--------------------	----





### ETHAFOAM TARGETS WITH REPLACEABLE CORE

- Used at many of the finest camp and school archery programs
- Features an 18" replaceable core
- 6" thick foam is weather/insect proof with self healing tendency
- Target stand sold separately
- Target face included

<b>1375654</b>	36" Square	\$189 <sup>22</sup> EA ★
<b>1375655</b>	36" Round	\$189 <sup>22</sup> EA ★
<b>1375656</b>	48" Square	\$269 <sup>22</sup> EA ★
<b>1375657</b>	48" Round	\$269 <sup>22</sup> EA ★
<b>ARCORE</b>	18" Replacement Cores - Fits 36" and 48"	\$199 <sup>22</sup> SET OF 3 ★



### E-Z TARGET

- Finally a good quality, economical foam target for institutional use
- 36" square and 3 1/2" thick
- Comes complete with stand and paper target face
- Lightweight for easy set up and take down
- For bows up to 40 lbs.

**30 Day Limited Warranty**

**1308563** \$64<sup>22</sup> EA



### FOAM TARGETS

- 100% self-healing foam - 6" thick
- Waterproof, UV resistant and impervious to insects
- Reversible - adds life to your target
- Target face included

<b>3739XXXX</b>	36" - 12 lbs.	\$269 <sup>22</sup> EA
<b>3740XXXX</b>	48" - 18 lbs.	\$349 <sup>22</sup> EA



### ROLLED FOAM TARGET

- Lighter weight for easy set up and storage
- Features "Rolled Heat Bond" - foam strips laminated under heat and pressure
- Arrows cause much less permanent damage
- Available in 36" and 48" diameters
- Approximately 7" thick
- Target face included

<b>NECA236X</b>	36" - 15 lbs.	\$199 <sup>22</sup> EA
<b>NECA248X</b>	48" - 30 lbs.	\$299 <sup>22</sup> EA

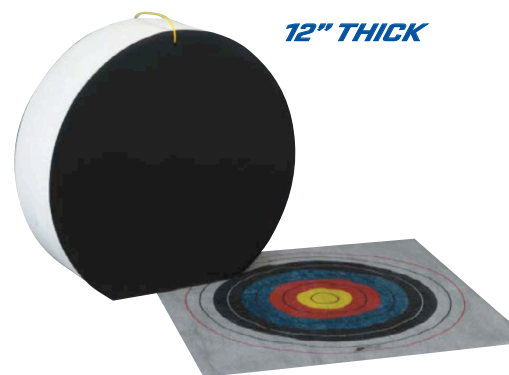

**12" THICK**

### FREE STANDING ROLLED FOAM TARGET

- Features "Rolled Heat Bond" - foam strips laminated under heat and pressure
- No stand needed because bottom is flat
- 36" tall and 12" thick
- Built-in carry handle
- 4 color hang on face included

**NECAS36** 36" - 30 lbs. \$239<sup>22</sup> EA



### TARGET STANDS

- Holds 36" and 48" targets

<b>3718XXXX</b>	Wheeled Stand	\$99 <sup>22</sup> EA ★
<b>1197761</b>	Tripod Stand	\$49 <sup>22</sup> EA ★



### MONSTER TARGET STAND

- Adjustable - holds all targets 30" - 50" in diameter
- Constructed using 1 1/3" galvanized steel tubing
- Large wheels allow for easy rolling

**4 Year Limited Warranty**  
**ARTARSTD** \$169<sup>22</sup> EA ★

### ARCHERS' FAVORITE FIBERCLOTH FACES



#### ROUND TARGET FACES

- Long lasting, fibercloth material
- Waterproof - skirted

<b>1282566</b>	48" - Slip-On	\$28 <sup>22</sup> EA ★
<b>1282580</b>	36" - Slip-On	\$18 <sup>22</sup> EA ★

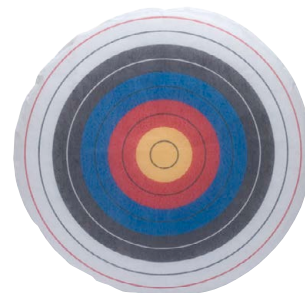

#### SQUARE TARGET FACES

- Long lasting, fibercloth material
- Waterproof - no skirt

<b>1282573</b>	48" - Flat	\$25 <sup>22</sup> EA ★
<b>1282597</b>	36" - Flat	\$16 <sup>22</sup> EA ★

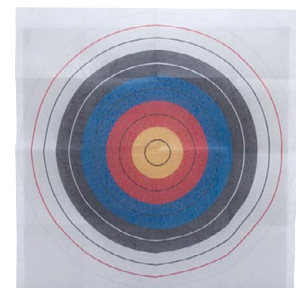

- Abdominal Exerciser . . . . . 235  
 Abwheel . . . . . 250  
 Accelerometers . . . . . 269  
 ADA Bleachers . . . . . 11-12  
 Adjustable Basketball Systems . . . . . 98, 100-101  
 Adjustable/Portable Basketball Standards . . . . . 100-101  
 Advantage Court Repair . . . . . 166  
 Aerobic Steps . . . . . 258  
 Agility Ladder/Trainers 121, 259, 262-263  
 Air Hockey Tables/Accessories . . . . . 302  
 Air Horn . . . . . 286  
 Aluminum Channeling . . . . . 275, 334-335  
 Ankle Braces . . . . . 324  
 Archery . . . . . 357-359  
 Arrows, Archery . . . . . 358
- ASSESSMENT . . . . . 265-273**  
 Blood Pressure Monitors . . . . . 271  
 Body Fat Measurement . . . . . 271-272  
 Flex Testers . . . . . 270  
 Heart Rate Monitors . . . . . 265-267, 271  
 Jump & Reach Boards . . . . . 270  
 Pedometers & Accelerometers . . . . . 268-269  
 Pulse Oximeters . . . . . 272  
 Team System . . . . . 265-266  
 Scales . . . . . 272-273
- Back & Abdominal Exercise Bench 235  
 Backboard Padding . . . . . 107  
 Backboards, Basketball . . . . . 102-103  
 Backgammon . . . . . 304
- BACKPACKS . . . . .**  
 Baseball . . . . . 70-71  
 Field Hockey . . . . . 157  
 Lacrosse . . . . . 155  
 Badminton . . . . . 170-171  
 Baggio Toss Game . . . . . 349  
 Bags, Equipment . . . . . 70-71, 143, 193  
 Balance Disc . . . . . 252  
 Ball Baskets . . . . . 64  
 Ball Carriers/Lockers . . . . . 111, 330-333  
 Ball Hoppers . . . . . 165  
 Ball Racks . . . . . 111, 330-333
- BALLS . . . . .**  
 Baseballs . . . . . 56-59, 62-64  
 Baseballs - Flat Seam . . . . . 56  
 Basketballs . . . . . 94-97, 338  
 Blast Balls . . . . . 350  
 Bocce Balls . . . . . 347  
 Bowling . . . . . 344  
 Cageballs . . . . . 342  
 Cush-N-Catch Balls . . . . . 340  
 Dodgeballs . . . . . 341  
 Field Hockey Balls . . . . . 156  
 Floor Hockey . . . . . 352  
 Foam Balls . . . . . 340-341  
 Footballs . . . . . 116-118, 338  
 Four Square . . . . . 338  
 Futsal . . . . . 176-177  
 Golf Balls . . . . . 356  
 Handballs . . . . . 172  
 Have a Ball Value Pack . . . . . 337  
 Heavy Basketballs . . . . . 97  
 Incrediballs . . . . . 62  
 Jelly Ball . . . . . 340  
 Kickballs . . . . . 338  
 Kin-Ball . . . . . 342  
 Lacrosse Balls . . . . . 155  
 Medicine Balls . . . . . 247  
 Omnikin Balls . . . . . 342  
 Pickle Balls . . . . . 346  
 Ping Pong . . . . . 298  
 Pitching Machine Balls . . . . . 55  
 Playground Balls . . . . . 339  
 Racquetballs . . . . . 173
- Reaction Ball . . . . . 262  
 Rubber Sport Balls . . . . . 337-338  
 Six Color Packs . . . . . 337  
 Soccer Balls . . . . . 174-177, 338  
 Softballs . . . . . 60-64  
 Special Tuff Balls . . . . . 341  
 Squash . . . . . 172  
 Stability Balls . . . . . 252-253  
 Table Tennis . . . . . 298  
 Tee Balls . . . . . 62  
 Tennis Balls . . . . . 168  
 Tennis Trainers . . . . . 168, 340  
 Tetherball . . . . . 351  
 Total Control Balls . . . . . 63  
 Training Balls . . . . . 337-338, 350  
 Unbelievaball . . . . . 62  
 Utility Balls . . . . . 338  
 Value Packs . . . . . 337  
 Volleyballs . . . . . 210-213  
 Wallyball . . . . . 219  
 Wiffle Balls . . . . . 63  
 Z-Balls . . . . . 262
- Bar Lifter . . . . . 199  
 Bar Wrap Pads . . . . . 226
- BASEBALL . . . . . 16-85**  
 Accubat . . . . . 81  
 Backpacks . . . . . 70-71  
 Backstops & Padding . . . . . 16-19, 24-25  
 Ball Baby . . . . . 85  
 Ball Bags, Umpire . . . . . 77  
 Ball Baskets . . . . . 64  
 Ball Bucket . . . . . 64  
 Base Caddy . . . . . 47  
 Base Plugs . . . . . 48, 50  
 Baseball Caps . . . . . 86-87  
 Baseball Foul Poles . . . . . 28, 32  
 Baseball Jerseys . . . . . 88-93  
 Baseball Pants . . . . . 88-89  
 Baseball/Softball Belts . . . . . 88  
 Baseball/Softball Rule Book . . . . . 84  
 Baseballs . . . . . 56-59, 62-64  
 Baseballs - Flat Seam . . . . . 56  
 Bases . . . . . 47-51  
 Bat Bag . . . . . 70-71  
 Bat Caddy . . . . . 68  
 Bat Rack . . . . . 85  
 Bat, Stick Training Bat . . . . . 81  
 Bats . . . . . 66-69, 81  
 Batters Box Foundations . . . . . 38-39  
 Batters Box Template . . . . . 45  
 Batting Cages & Accessories . . . . . 16-19  
 Batting Helmets . . . . . 72,73  
 Batting Practice Turf Blanket . . . . . 34-35  
 Batting Tees . . . . . 65  
 Batting Tunnel/Cage Savers . . . . . 21  
 Batting Tunnels . . . . . 20  
 Batting Tunnels - Netting . . . . . 21, 29  
 Big Bubba Pro Batting Cage . . . . . 19  
 Bubba Elite Batting Cage . . . . . 16-17  
 Catcher's Equipment Bag . . . . . 70-71, 76  
 Catcher's Helmets/Gear . . . . . 74-76  
 Catcher's Mitts . . . . . 78-80  
 Catching Mat . . . . . 37  
 Clay, Baseball/Softball Field . . . . . 39  
 Double First Bases . . . . . 47-51  
 Drag Mats . . . . . 40-41  
 Dry Line Markers . . . . . 45, 293  
 Dugout Organizer Rack . . . . . 85  
 Fence Guard . . . . . 25  
 Fence Stakes . . . . . 30-31  
 Fencing . . . . . 30-32  
 Fencing, Smart Poles . . . . . 30-31  
 Field Conditioners . . . . . 39  
 Field Covers/Tarps . . . . . 33-35  
 Field Groomer . . . . . 40-41  
 Field Markers/Strippers . . . . . 45, 292-293  
 Field Marking Paint . . . . . 45, 293
- Field Marking Stick . . . . . 45, 293  
 Field Marking Systems . . . . . 290-291  
 Field Tarp Roller . . . . . 33  
 Glovers Binder . . . . . 84  
 Gloves . . . . . 78-80  
 Grass Protectors . . . . . 34-35  
 Ground Anchors, Baseball . . . . . 48, 50-51  
 Ground Stakes, Baseball . . . . . 30-31  
 Helmet Caddy . . . . . 85  
 Hit-A-Way . . . . . 81  
 Hitting Mats, Baseball/Softball . . . . . 37  
 Hitting Nets . . . . . 83  
 Hitting Trainer . . . . . 81  
 Home Plates . . . . . 46, 48, 50-51  
 Hoses . . . . . 44  
 Incrediballs . . . . . 62  
 Instructo-Swing . . . . . 81  
 Jox Box . . . . . 38  
 Lightning/Storm Detector . . . . . 54  
 Line-Up Cards . . . . . 84  
 Line-Up/Field Boards . . . . . 84  
 Loop Hoe Edger . . . . . 43  
 Marking Dust . . . . . 39  
 Mops, Infield Finishing . . . . . 42  
 Mound & Base Covers . . . . . 33-35  
 Mound Slope Gauge . . . . . 43  
 Net Saver . . . . . 21  
 Netting . . . . . 21, 29  
 Nozzles . . . . . 44  
 On-Deck Circle . . . . . 37  
 Overseed Enhancing Tool . . . . . 43  
 Paint, Field Marking . . . . . 45, 293  
 Pitch Counter . . . . . 54  
 Pitch Indicator . . . . . 54  
 Pitcher Practice Screen . . . . . 22-23, 83  
 Pitchers Mounds . . . . . 52-53  
 Pitchers Plate . . . . . 46  
 Pitchers Rubbers . . . . . 46, 50-51  
 Pitchers Training Plates . . . . . 48, 81  
 Pitching Machines . . . . . 55  
 Pitching Machine Balls . . . . . 63  
 Pitching Mat, Softball . . . . . 52  
 Pitching Mounds . . . . . 52-53  
 Pitching Target . . . . . 82  
 Plate Brush . . . . . 77  
 Playback Trainer . . . . . 82-83  
 Poly Cap . . . . . 25  
 Pop Up Nets . . . . . 83  
 Portable Backstops . . . . . 24  
 Portable Pitching Screen/Nets . . . . . 22-23, 83  
 Protective Screens/Baseball & Softball . . . . . 22-23, 83  
 Protector Nets . . . . . 21-23, 29  
 Radar Guns . . . . . 54  
 Rakes . . . . . 43  
 Ricochet Cushion . . . . . 18, 25  
 Rosin Bags . . . . . 54  
 Rule Books . . . . . 84  
 Safeoam Padding . . . . . 18  
 Scoreboards . . . . . 312-323  
 Screens, Ball Park . . . . . 22-24, 87  
 Shovels . . . . . 43  
 Slide Rite . . . . . 81  
 Slug Rite Tee . . . . . 65  
 Smart Pole Fencing . . . . . 30-31  
 Softball Helmets . . . . . 72,73  
 Softballs . . . . . 60-64  
 Softhands Infield Trainer . . . . . 84  
 Speed Gun . . . . . 54  
 Sportpanel Fencing . . . . . 32  
 Step-Down Rubbers . . . . . 46, 50  
 Stride Guide . . . . . 52  
 Strike Zone Home Plate . . . . . 82  
 Striker II Hitting Trainer . . . . . 81  
 String Winder . . . . . 39  
 Tally Counter . . . . . 54
- Tamp . . . . . 42  
 Tarp Cart . . . . . 34  
 Template, Batters Box . . . . . 45  
 Throat Protectors . . . . . 74  
 Throwdown Bases . . . . . 48  
 Total Control Balls . . . . . 63  
 Training Bats . . . . . 81  
 Turf . . . . . 36  
 Twine . . . . . 22, 39  
 Ultimate Pitching Machine . . . . . 39  
 Umpire Equipment . . . . . 77  
 Unbelieva-Ball . . . . . 62  
 Wheel Kit . . . . . 22  
 Wiffle Balls . . . . . 63  
 Windscreen . . . . . 26-27
- Base Pads, Volleyball . . . . . 223  
 Base Protector Pads . . . . . 170, 195
- BASKETBALL . . . . . 94-112**  
 Backboards . . . . . 102-103  
 Ball Racks . . . . . 111, 330-331  
 Coaching Boards . . . . . 110  
 Court Chairs . . . . . 108-109  
 Court Stencil . . . . . 112  
 Goals/Rims . . . . . 104-105  
 Gooseneck Systems . . . . . 99  
 Nets . . . . . 106  
 Outdoor Systems . . . . . 98-99  
 Padding . . . . . 99, 107  
 Rebounders . . . . . 112  
 Scoreboards . . . . . 312-315, 321  
 Scorer's Tables . . . . . 109  
 Scorebook . . . . . 110  
 Storage . . . . . 111, 312-315  
 Systems . . . . . 98-101  
 Uniforms . . . . . 113-115  
 Basketballs . . . . . 94-97, 338
- Bean Bags . . . . . 349
- BELTS . . . . .**  
 Baseball/Softball . . . . . 88  
 Flag . . . . . 146-147  
 Football . . . . . 145  
 Weight Lifting . . . . . 228
- Bench Press Machine (Selectorized) . . . . . 236, 239  
 Benches (Players) . . . . . 4-5  
 Benches (Fitness) . . . . . 230  
 Bicep Machine (Selectorized) . . . . . 226, 239  
 Big Bubba Pro Batting Cage . . . . . 19  
 Bike Racks . . . . . 310  
 Billiard Tables & Accessories . . . . . 300-301  
 Binder, Glovers . . . . . 84  
 Bingo . . . . . 304  
 Birdies, Badminton . . . . . 170  
 Blast Ball . . . . . 350  
 Bleachers . . . . . 6-15  
 Blocking Dummies . . . . . 122-123  
 Blongo Ball . . . . . 351  
 Blood Pressure Monitor . . . . . 271  
 Board Games/Table Games . . . . . 303-305  
 Bocce . . . . . 347  
 Body Composition Analyzer/Scale . . . . . 271-273  
 Body Fat Analyzer . . . . . 271-273  
 BOSU . . . . . 256  
 Boundry Markers . . . . . 167  
 Boundary Netting . . . . . 29  
 Bowling . . . . . 344  
 Bows, Archery . . . . . 357  
 Boxing Bags . . . . . 281-283  
 Boxing Gloves . . . . . 281  
 Brooms . . . . . 42  
 Bulletin Board . . . . . 307  
 Bumper Plates . . . . . 227  
 Bumper Pool . . . . . 300-301
- Cable Attachments . . . . . 234  
 Cable Crossover Machine . . . . . 239



- Cageballs . . . . . 342  
 Canopies . . . . . 15  
 Cards . . . . . 304  
 Carom Board . . . . . 303  
 Catcher's Equipment Bag . . . . . 70-71, 76  
 Catcher's Helmets/Gear . . . . . 74-76  
 Catcher's Mitts . . . . . 78-80  
 Center Strap . . . . . 161  
 Chain Sets . . . . . 127  
 Chainman's Vests . . . . . 127  
 Chairs, Court . . . . . 108-109  
 Chalk . . . . . 39, 197, 228, 280, 286  
 Checkers . . . . . 304  
 Chess . . . . . 304  
 Chest Press Machine (Selectorized) . . . . . 236  
 Chest Protectors, Baseball & Softball . . . . . 74-77  
 Chin & Dip Station . . . . . 235  
 Chin/Dip/Ab Station . . . . . 235  
 Chinning/Pull Up Bar . . . . . 235, 250  
 Cleat Cleaner . . . . . 39  
 Clocks . . . . . 207, 323
- CLOTHING**
- Baseball/Softball Uniforms . . . . . 88-93  
 Basketball Uniforms . . . . . 113-115  
 Caps & Visors . . . . . 86-87  
 Football Uniforms . . . . . 145  
 Girdles/Sliders . . . . . 139  
 Jerseys, Baseball/Softball . . . . . 88-93  
 Jerseys, Reversible . . . . . 113-115  
 Major & Minor League Replica . . . . .  
     Caps/Shirts/Jerseys/Visors . . . . . 90-93  
 Official's Jersey . . . . . 113  
 Scrimmage Vests . . . . . 144, 190  
 Shorts . . . . . 113-115  
 Socks . . . . . 88  
 Umpire Shirts/Caps . . . . . 77  
 Volleyball Jerseys/Shorts . . . . . 220
- COACHING BOARDS**
- Baseball/Softball . . . . . 84  
 Basketball . . . . . 110  
 Football . . . . . 119  
 Lacrosse . . . . . 155  
 Soccer . . . . . 192  
 Volleyball . . . . . 220
- COACHING SUPPLIES**
- Air Horns . . . . . 286  
 Coaching Boards . . . . .  
     84, 110, 119, 155, 192, 220  
 Coolers . . . . . 151-153, 164  
 Inflating Needles . . . . . 285  
 Lanyards . . . . . 284  
 Laundry Bags . . . . . 284  
 Locks . . . . . 307  
 Megaphones . . . . . 286  
 Officials Jersey . . . . . 113  
 Scrimmage Vests . . . . . 144, 190  
 Towels . . . . . 144, 151-152  
 Two-Way Radios . . . . . 287  
 Water Coolers . . . . . 151-153, 164  
 Whistles . . . . . 284  
 Coach's Bag . . . . . 193  
 Cold Packs . . . . . 325  
 Collars, Spring . . . . . 226  
 Column Pads . . . . . 336  
 Competition Bench . . . . . 230  
 Concessions . . . . . 288-289  
 Cones . . . . . 191, 343  
 Cooler Stand . . . . . 151-152, 164  
 Coolers . . . . . 151-153, 164  
 Cooling Systems . . . . . 148-149, 152  
 Corner Flags . . . . . 191, 291  
 Court Chairs . . . . . 108-109  
 Court Marker . . . . . 112, 166  
 CourtClean . . . . . 110  
 Covers, Gym Floor . . . . . 294-295  
 Croquet Set . . . . . 347
- Crossbars . . . . . 198-199  
 Cups . . . . . 150, 153, 289  
 Curl Bars . . . . . 226  
 Curl Bench . . . . . 230  
 Custom Netting . . . . . 29
- D-Man . . . . . 112  
 Decline Bench . . . . . 230  
 Diamond Pro Products . . . . . 39  
 Dip Belt . . . . . 235  
 Dip Station, Free-Standing . . . . . 235  
 Disc Golf . . . . . 348  
 Discus . . . . . 204  
 Discus Cage . . . . . 206  
 Discus/Shot Carrier . . . . . 205  
 Discus/Shotput Circles . . . . . 206  
 Display Cases . . . . . 307  
 Distance Marker . . . . . 26  
 Dodgeballs . . . . . 341  
 Dominoes . . . . . 304  
 Dot Drill Mat . . . . . 263  
 Double First Bases . . . . . 47-51  
 Double Shot Basketball Game . . . . . 303  
 Down Box/Chain Set . . . . . 127  
 Down Boxes . . . . . 127  
 Drag Mats . . . . . 40-41  
 Dribble Specs . . . . . 112  
 Drinkers . . . . . 148-149  
 Dry Line Markers . . . . . 45, 293  
 Dual-Resistance Harness . . . . . 261  
 Duffie Bags . . . . . 70-71, 142, 187  
 Dumbbell Racks . . . . . 229  
 Dumbbells . . . . . 229  
 Dummies, Football . . . . . 122-123  
 Duraskin Backboard Padding . . . . . 107
- Easy-Up Youth Mini Goal . . . . . 101  
 Ekho . . . . . 209, 265, 267, 269, 272, 285  
 Electronic Whistles . . . . . 284  
 Elliptical Trainers . . . . . 243  
 Equipment Carts . . . . .  
     111, 126, 167, 222, 332-333  
 Exercise Bikes . . . . . 244-245  
 Exercise Mats . . . . . 254-255  
 Eye Goggles . . . . . 172  
 E-Z Curl Bar . . . . . 226  
 E-Z Fold Cart . . . . . 221
- Fence Guard . . . . . 25  
 Fence Stakes . . . . . 30-31  
 Fencing . . . . . 30-32  
 Fencing, Smart Poles . . . . . 30-32, 290  
 Field Covers/Tarps . . . . . 33-35, 128-129, 207  
 Field Distance Markers, Track . . . . . 205  
 Field Groomer . . . . . 40-41  
 Field Hockey Balls . . . . . 156  
 Field Hockey Equipment . . . . . 156-157  
 Field Markers/Strippers . . . . . 45, 293  
 Field Marking Paint . . . . . 45, 293  
 Field Marking Stick . . . . . 45, 293  
 Field Marking Systems . . . . . 30-31, 290-291  
 Field Tarp Roller . . . . . 33  
 First Aid Kits & Supplies . . . . . 326  
 Fitness Bands . . . . . 248, 251  
 Fitness Cart . . . . . 258, 325
- FITNESS EQUIPMENT**
- Abwheel . . . . . 250  
 Aerobic Steps . . . . . 258  
 Benches . . . . . 230  
 Bikes . . . . . 244-245  
 Body Bars . . . . . 248  
 Body Fat Analyzer . . . . . 271-272  
 Elliptical Trainers . . . . . 243  
 Exercise Mats . . . . . 254-255  
 Foam Plyo Boxes . . . . . 257  
 Foam Rollers . . . . . 255  
 Heart Rate Monitors . . . . . 265-267  
 Mat Cleaner . . . . . 328
- Medicine Balls . . . . . 247  
 Pedometers . . . . . 268-269  
 Pilates Equipment . . . . . 255  
 Plyometric Platforms . . . . . 257  
 Scales . . . . . 272-273  
 Skinfold Caliper . . . . . 271  
 Speed Trainers . . . . . 260-261  
 Stability Balls/Carts . . . . . 252-253  
 Stairclimbers/Steppers . . . . . 243  
 Step Carts . . . . . 258, 325  
 Treadmills . . . . . 242  
 Weight Room Flooring . . . . . 240-241  
 Fitness Mats . . . . . 254-255  
 Fitness Rings . . . . . 248  
 Fitness Step Cart . . . . . 258  
 Flack Vest . . . . . 138, 140
- FLAG FOOTBALL . . . . . 146-147**
- Flag-A-Tag Belts . . . . . 146  
 Flag-A-Tag Gamebook . . . . . 146  
 Flag Football Ball Spotter . . . . . 147  
 Triple Threat Belts . . . . . 147  
 Flashing Cone . . . . . 329  
 Flat Bench . . . . . 230  
 Flexibility Testing . . . . . 270  
 Flex-I-Wrap . . . . . 325  
 Floor Covers . . . . . 294-295  
 Floor Hockey Cart . . . . . 354  
 Floor Hockey Equipment . . . . . 352-355  
 Floor Marking Tape/Applicator . . . . . 294  
 Flooring, Exercise/Weight Room . . . . .  
     240-241  
 Flying Discs/Saucers . . . . . 348-349  
 Foam Balls . . . . . 340-341  
 Foosball Tables/Accessories . . . . . 299
- FOOTBALL . . . . . 116-145**
- Balls . . . . . 116-118, 338  
 Belts . . . . . 145  
 Cooling Systems . . . . . 148, 152  
 Down Indicators & Chain Sets . . . . . 127  
 Dummies & Shields . . . . . 122-123  
 Flag Football . . . . . 146-147  
 Gatorade . . . . . 150-151  
 Girdles . . . . . 139  
 Goalposts/Pads . . . . . 130-131  
 Helmet Carts . . . . . 142  
 Helmet Accessories . . . . . 141  
 Hydration . . . . . 148-153  
 Jerseys . . . . . 145  
 Kicking Cages . . . . . 125  
 Mouthguards . . . . . 143  
 Officials Equipment . . . . . 127  
 Pant Pads . . . . . 140  
 Pants . . . . . 145  
 Passing Machine . . . . . 119  
 Scoreboards, Play Clocks & Timers . . . . .  
     310-311  
 Shoulder Pad Racks . . . . . 142  
 Shoulder Pads . . . . . 128-129  
 Sideline Markers, Pylons . . . . . 126  
 Sideline Protectors . . . . . 128-129  
 Sleds . . . . . 120-122, 124  
 Stat Book . . . . . 119  
 Team Drinkers . . . . . 148-149  
 Wristcoaches . . . . . 144  
 Football/Soccer Combo Goal . . . . . 135, 179  
 Frisbee Golf . . . . . 348  
 FUNNETS Goals . . . . . 189, 354
- FUTSAL**
- Balls . . . . . 176-177  
 Goals . . . . . 187
- Game Clock . . . . . 312-323  
 Game Cones . . . . . 191, 321, 343  
 Game Standards, Volleyball . . . . . 223  
 Game Table, Flip Table . . . . . 302  
 Game Tables . . . . . 296-303  
 Gatorade . . . . . 150-151
- Gear Pro-Tec . . . . . 132-139  
 Girdles . . . . . 139  
 Girdle Inserts . . . . . 138, 140
- GLOVES**
- Baseball/Softball . . . . . 78-80  
 Boxing . . . . . 281  
 Field Hockey . . . . . 158  
 Goalie . . . . . 192  
 Weight Training/Workout . . . . . 228
- GOGGLES**
- Field Hockey . . . . . 157  
 Floor Hockey . . . . . 352  
 Racquet Ball/Squash . . . . . 172
- GOALS**
- Basketball . . . . . 104-105  
 Easy-Up Youth Mini Goal . . . . . 101  
 Field Hockey . . . . . 156  
 Floor/Street Hockey . . . . . 354  
 Football/Soccer Combo . . . . . 135, 179  
 Futsal . . . . . 187  
 Frisbee Golf . . . . . 348  
 Lacrosse Goals . . . . . 154-155  
 Soccer . . . . . 179-190, 354
- Golf . . . . . 356  
 Grass Protectors . . . . . 33-35  
 Grate Covers/Guards . . . . . 38  
 Grills . . . . . 311  
 Ground Anchors, Baseball . . . . . 48, 50-51  
 Ground Sleeves . . . . .  
     47-48, 51, 126, 127, 158, 179  
 Gym Chalk . . . . . 228, 280  
 Gym Floor Covers . . . . . 294-295  
 Gym Flooring . . . . . 294-295  
 Gym Wipes Buckets . . . . . 328  
 Gymnastics . . . . . 280
- Hack Squat Machine . . . . . 233  
 Handball . . . . . 172  
 Headbands, Tennis Net . . . . . 161  
 Headgear, Wrestling . . . . . 225  
 Headset, Coaches . . . . . 287  
 Heart Rate Monitors . . . . . 265-267, 271  
 Heat Index Warning System . . . . . 150  
 Heavy Bags . . . . . 283  
 Heavy Basketballs . . . . . 97  
 Helmet Caddy . . . . . 85  
 Helmet Covers . . . . . 144  
 Helmet Hardware . . . . . 141  
 Helmet Inflator . . . . . 141  
 Helmet Rack/Tree . . . . . 87, 142  
 High Jump Pits/Standards . . . . . 196-198  
 Hip Flexor Machine (Selectorized) . . . . . 236  
 Hip Pads, Football . . . . . 140  
 Hitting Mats, Baseball/Softball . . . . . 37  
 Hitting Trainer . . . . . 81  
 Hockey Equipment, Floor/Street . . . . . 352-355  
 Home Plates . . . . . 46, 48, 50-51  
 Hoops . . . . . 349  
 Hoppers . . . . . 344  
 Horseshoes . . . . . 347  
 Hoses/Accessories . . . . . 44  
 Huddle Zone Special Teams Mat . . . . . 128  
 Hurdle Carts . . . . . 202  
 Hurdles . . . . . 202-203
- HYDRATION . . . . . 148-153**
- Coolers . . . . . 151-153  
 Cups . . . . . 150, 153  
 Gatorade . . . . . 150-151  
 Sports Cool . . . . . 148-149  
 Towels . . . . . 151-152  
 Water Bottles . . . . . 150-151
- I-Beam Pads . . . . . 336  
 Ice Bags . . . . . 325  
 Ice Chest . . . . . 151, 153  
 Incline Bench . . . . . 230  
 Incline Rower (Plate Load) . . . . . 234

- Incline Support Bench . . . . . 230  
 Indoor Bleachers . . . . . 6-7, 10  
 Inflating Needles . . . . . 285  
 Inflators . . . . . 285, 342
- 
- Jaw Pads, Football . . . . . 141  
 Jerseys, Baseball . . . . . 88-93  
 Jox Box . . . . . 38  
 Judges Stand, Track . . . . . 207  
 Judges Stands/Pads, Volleyball 217, 222  
 Juggling . . . . . 351  
 Jump & Reach Board . . . . . 270  
 Jump Rope Racks . . . . . 345  
 Jump Ropes . . . . . 345
- 
- Kettlebells . . . . . 246  
 Kicking Cages . . . . . 125  
 Kicking Tees . . . . . 118  
 Knee Braces . . . . . 324  
 Knee Pads, Football . . . . . 138, 140  
 Knee Pads, Volleyball . . . . . 220  
 Kwik Goal . . . . . 155, 184-186
- 
- LACROSSE** . . . . .  
 Balls . . . . . 155  
 Heads/Sticks . . . . . 350  
 Goals . . . . . 154-155  
 Scoreboards . . . . . 321  
 Training . . . . . 350  
 Ladder Ball . . . . . 351  
 Land Mine Trainer . . . . . 227  
 Lanyards . . . . . 284  
 Lap Counter . . . . . 207  
 Lat Pull & Row Machine (Selectorized) . . . . . 237, 239  
 Lat Pull Machine (Plate Load) . . . . . 234  
 Laundry Bags . . . . . 284  
 Laundry Belts . . . . . 284  
 Leg Extension Machine (Selectorized) . . . . . 239  
 Leg Extension/Leg Curl Machine (Plate Load) . . . . . 233  
 Leg Guards, Baseball/Softball . . . . . 74-77  
 Leg Press (Plate Load) . . . . . 233  
 Leg Press (Selectorized) . . . . . 237  
 Lifting Belts . . . . . 228  
 Lifting Gloves . . . . . 228  
 Lifting Straps . . . . . 228  
 Lightning/Storm Detector . . . . . 54, 150  
 Lineman Chutes . . . . . 120  
 Lineman Splits Marker . . . . . 120  
 Line-Mate Field Marking Systems . . . . . 292-293  
 Linesman Flags . . . . . 192  
 Line-Up Cards . . . . . 84  
 Line-Up/Field Boards . . . . . 86, 110, 119, 155, 192, 220  
 Lockers & Locks . . . . . 306-307  
 Long Jump Mat . . . . . 270  
 Low Rise Bleachers . . . . . 6  
 Low Row Machine (Selectorized) . . . . . 237, 239  
 Low-Profile Cones . . . . . 191
- 
- Major & Minor League Replica Caps/Shirts/Jerseys/Visors . . . . . 90-91  
 Marking Dust . . . . . 39  
 Master Lock . . . . . 307  
 Mat Cleaner . . . . . 328  
 Mat Tape . . . . . 225, 277  
 Mat Truck/Transporter . . . . . 277
- 
- MATS** . . . . .  
 Bonded Foam . . . . . 274  
 Carpet/Foam Floor . . . . . 279  
 Carts . . . . . 277  
 Column Pads . . . . . 336  
 Custom . . . . . 334-336  
 Downhill . . . . . 280
- 
- Drag Mats . . . . . 40-41  
 EnviroSafe . . . . . 278  
 Exercise . . . . . 254-255  
 Expando . . . . . 276-277  
 Fitness . . . . . 254-255  
 Gymnastic/Tumbling . . . . . 274-280  
 Hitting, Baseball/Softball . . . . . 37  
 Incline Mats . . . . . 280  
 Landing Mats . . . . . 279  
 Multi-Purpose Mat . . . . . 336  
 Pitching . . . . . 52  
 Rainbow Mat . . . . . 276  
 Sideline Protective Mat . . . . . 128-129  
 Smart Mat . . . . . 254  
 Stage/Wall Pads . . . . . 334-336  
 Tape . . . . . 277  
 Ultimat . . . . . 275  
 Walkway . . . . . 294  
 Wall Pads . . . . . 334-336  
 Wrestling . . . . . 225  
 Yoga . . . . . 254-255
- 
- McCall's Rebounder . . . . . 112  
 Measuring Tapes . . . . . 206  
 Measuring Wheels . . . . . 206  
 Medicine Balls & Accessories . . . . . 247, 249  
 Megaphones . . . . . 286  
 Mini & Maxi-Net Systems . . . . . 167  
 Mission Athlete Care . . . . . 328  
 Monster Sled . . . . . 261  
 Mound & Base Covers . . . . . 33-35  
 Mound Slope Gauge . . . . . 43  
 Mouth Guards . . . . . 143  
 Multi Bench . . . . . 230  
 Multi-Fit System . . . . . 237-239  
 Multi-Game Boards . . . . . 303  
 Multi-Hip Flex . . . . . 236  
 Multi-Rack . . . . . 231-232  
 Multipoint Tabletop Scoreboard . . . . . 312-313  
 Multi-Station Machines . . . . . 237-239
- 
- Neck Machine . . . . . 234  
 Net Setter Chain . . . . . 220
- 
- NETS** . . . . .  
 Archery . . . . . 358  
 Backstop Replacement Net . . . . . 29  
 Badminton . . . . . 170  
 Baseball/Softball Nets . . . . . 16, 18, 19, 21-24, 29  
 Baseball/Softball Protectors . . . . . 22-23  
 Basketball . . . . . 106  
 Batting Cage Nets . . . . . 16, 18-19, 21  
 Boundary . . . . . 29, 161, 187  
 Field Hockey . . . . . 156  
 Floor Hockey . . . . . 354  
 Funnets® . . . . . 189, 346  
 Golf . . . . . 356  
 Lacrosse . . . . . 154, 155  
 Mini & Maxi-Net Systems . . . . . 167, 346  
 Net Saver . . . . . 21  
 Passing Drill Net . . . . . 125  
 Soccer . . . . . 178  
 Table Tennis . . . . . 298  
 Tennis . . . . . 158-159  
 Volleyball . . . . . 216-218  
 Wallyball . . . . . 219
- 
- Official's Jersey . . . . . 113  
 Official's Penalty Flag . . . . . 127  
 Olympic Bar Holder . . . . . 226-227  
 Olympic Plate Holder . . . . . 227  
 Olympic Style Bars . . . . . 226  
 Olympic-Style Weight Sets . . . . . 227  
 Outdoor Basketball Units . . . . . 98-99  
 Outdoor Benches & Tables . . . . . 308-311
- 
- PA System . . . . . 286-287  
 Padding, Backstop . . . . . 28  
 Paddles, Ping Pong . . . . . 298
- 
- Paint, Field Marking . . . . . 45, 293  
 Paint, Tennis Court . . . . . 166  
 Pants, Baseball . . . . . 88-89  
 Parachutes . . . . . 344  
 Park Benches . . . . . 308-311  
 Park Equipment . . . . . 308-311  
 Passing Drill Net . . . . . 121  
 Peanutball . . . . . 252  
 Pec Dec Machine (Selectorized) . . . . . 236  
 Pedometers . . . . . 268-269  
 Peg Boards . . . . . 250  
 Pennant Streamers . . . . . 343  
 Performance Indicators, Track . . . . . 207  
 Physical Education . . . . . 338-355  
 Pickle Ball . . . . . 346  
 Picnic Tables . . . . . 308-311  
 Pilates Equipment . . . . . 254-255  
 Pillo Hockey/Pillo Polo . . . . . 355  
 Ping Pong . . . . . 296-298  
 Pit Covers . . . . . 194-197, 207  
 Pitch Counter . . . . . 54  
 Pitcher Practice Screen . . . . . 22-23, 83  
 Pitchers Mounds . . . . . 52-53  
 Pitchers Plate . . . . . 46  
 Pitchers Rubbers . . . . . 46-51  
 Pitching Machines . . . . . 55  
 Pitching Machine Balls . . . . . 63  
 Pitching Target . . . . . 82  
 Plate Brush . . . . . 77  
 Plates, Weight . . . . . 227  
 Player's Benches . . . . . 4-5  
 Playground Balls . . . . . 339  
 Playground Basketball Posts . . . . . 98-99  
 Playground Carts . . . . . 330-333  
 Playing Cards . . . . . 304  
 Plyometric Platforms . . . . . 257  
 Pocket Golf . . . . . 303  
 Pole Vault Equipment . . . . . 194-197, 199  
 Poly Cap . . . . . 25  
 Pool Tables & Accessories . . . . . 300-301  
 Pop Up Nets . . . . . 82, 188  
 Portable Backstops . . . . . 24  
 Portable Basketball Standards . . . . . 100-101  
 Portable Cooling System . . . . . 148, 152  
 Portable Pitching Screen/Nets . . . . . 22-23  
 Portable Tennis System . . . . . 161, 167, 346  
 Possession Indicators . . . . . 109, 322  
 Post Pads . . . . . 98-99, 130, 180  
 Power Bench . . . . . 230  
 Power Lift Platform . . . . . 231  
 Power Racks . . . . . 231-232  
 Power Ram Sled Hack-Machine/Leg Press . . . . . 233  
 Pre Wrap . . . . . 327  
 Protective Screens/Baseball & Softball . . . . . 22-23, 83  
 Protector Nets . . . . . 22-23, 83  
 PUGG Goals . . . . . 188  
 Pull Up Bars . . . . . 242  
 Pulsemeter . . . . . 271  
 Push-Up Tester . . . . . 270  
 Pylons . . . . . 126, 329
- 
- Quadpods . . . . . 303  
 Quick Feet Agility Trainer . . . . . 263  
 Quik Shade Canopies . . . . . 15
- 
- Race Clock . . . . . 207  
 Racket Caddy . . . . . 167  
 Racks, Dumbbell . . . . . 229  
 Racks, Medicine Ball . . . . . 249  
 Racquetball . . . . . 173
- 
- RACQUETS** . . . . .  
 Badminton . . . . . 171  
 Paddleball . . . . . 172  
 Racquetball . . . . . 173  
 Squash . . . . . 172  
 Tennis . . . . . 169
- 
- Radio, Coaches . . . . . 287  
 Rakes . . . . . 43  
 RAZOR Shoulder Pads . . . . . 132-133  
 Ramp Shot . . . . . 347  
 Reaction Ball . . . . . 262  
 Recumbent Bikes . . . . . 244  
 Relay Batons . . . . . 201  
 Resistance Tubes/Bands . . . . . 251, 253  
 Reversible Jerseys . . . . .  
 Basketball . . . . . 113-115  
 Rib Protector . . . . . 138, 139  
 Ricochet Cushion . . . . . 16, 18-19  
 Rims . . . . . 104-105  
 Rol Dri Sponge Rollers . . . . . 160  
 Ropes . . . . .  
 Fitness Power/Battling Ropes . . . . . 259  
 Jump Ropes . . . . . 259, 345  
 Tug-O-War . . . . . 344  
 Rosin Bags . . . . . 54  
 Runner Mats . . . . . 294  
 Running Ropes . . . . . 121, 263  
 Runway, Rollout . . . . . 207
- 
- Safeoam Padding . . . . . 18  
 Safety Ratchet, Tennis . . . . . 158  
 Sandbags . . . . . 33, 178  
 Scales . . . . . 272-273  
 Scoop Ball . . . . . 350  
 Scooter Boards . . . . . 349  
 Scoreboards . . . . . 312-323
- 
- SCOREBOOKS** . . . . .  
 Baseball/Softball . . . . . 84  
 Basketball . . . . . 110  
 Football . . . . . 119  
 Lacrosse . . . . . 155  
 Soccer . . . . . 192  
 Tennis . . . . . 167  
 Volleyball . . . . . 220  
 Wrestling . . . . . 225  
 Scoring Tables . . . . . 109  
 Screens, Ball Park . . . . . 121-23, 29  
 Scrimmage Vests . . . . . 144, 190  
 Shade Canopies . . . . . 15  
 Shields . . . . . 122  
 Shin Guards . . . . . 192  
 Shiver Pads . . . . . 122  
 Shooter Ring . . . . . 112  
 Shot Clocks . . . . . 312, 315  
 Shot Puts . . . . . 205  
 Shot/Discus Carrier . . . . . 205  
 Shot/Discus Circles . . . . . 206  
 Shotgun Toe Board . . . . . 206  
 Shoulder Pad Rack . . . . . 142  
 Shoulder Pads & Accessories . . . . . 132-139, 141  
 Shoulder Press Machine (Selectorized) . . . . . 246  
 Shoulder Resistance Harness . . . . . 260-261  
 Shovels . . . . . 43  
 Shuffleboard . . . . . 299, 347  
 Shuttlecocks . . . . . 170  
 Sideline Kits . . . . . 141  
 Sideline Markers . . . . . 126  
 Sideline Protective Mat . . . . . 128-129  
 Sign Stands . . . . . 329  
 Sit Up Board . . . . . 235  
 Skinfold Caliper . . . . . 271  
 SKLZ . . . . . 82, 112  
 Skyscan . . . . . 54, 150  
 Sleds, Football . . . . . 120-122, 124  
 Slipp-Nott . . . . . 110  
 Smith Machine . . . . . 232
- 
- SOCCER** . . . . . **174-193**  
 Bag . . . . . 193  
 Balls . . . . . 174-177, 338  
 Bench . . . . . 188  
 Cones . . . . . 191

- Corner Flags . . . . . 191  
 Funnets® . . . . . 189  
 Goalie Gloves . . . . . 192  
 Goal Accessories . . . . . 178  
 Goals (Club/Competition) . . . . . 179-185  
 Goals (Practice/Training) . . . . . 187-190  
 Headgear . . . . . 193  
 Nets . . . . . 178  
 Referee Supplies . . . . . 192  
 Scoreboards . . . . . 320  
 Scorebook . . . . . 192  
 Scrimmage Vests . . . . . 190  
 Shin Guards . . . . . 192  
 Shelters, Team . . . . . 186  
 Socks . . . . . 88  
 Softballs . . . . . 60-64  
 Speed Bags . . . . . 282  
 Speed Chute . . . . . 261  
 Speed Trainers . . . . . 260-261  
 SpeedSac . . . . . 261  
 SpikeBall . . . . . 348  
 Spikeblaster, Volleyball . . . . . 219  
 Spikes, Track . . . . . 201  
 Sportpanel Fencing . . . . . 32  
 Sports Cool . . . . . 148-149  
**SPORTS MEDICINE 324-328**  
 Ankle Braces . . . . . 324  
 Athletic & Trainers Tape . . . . . 327  
 Bandages . . . . . 326-327  
 Cold Packs . . . . . 325  
 Disinfectants . . . . . 328  
 First Aid Kits & Supplies . . . . . 326  
 Ice Therapy Braces . . . . . 325  
 Knee Braces . . . . . 324  
 Sports Wristband . . . . . 113, 144  
 Spots . . . . . 343  
 Spring Boards . . . . . 280  
 Spring Collars . . . . . 226  
 Squash . . . . . 172  
 Squat Rack . . . . . 232  
 Stage Pads . . . . . 336  
 Stairclimbers/Steppers . . . . . 243  
 Standard Bench . . . . . 230  
 Starting Block Cart . . . . . 201  
 Starting Blocks . . . . . 200-201  
**STENCILS**  
 Basketball Court . . . . . 112  
 Football Field . . . . . 295  
 Step Squat Rack . . . . . 232  
 Stopwatches . . . . . 208-209, 385  
**STORAGE & TRANSPORT**  
 Archery . . . . . 357  
 Ball Carts . . . . . 111, 330-331  
 Ball Equipment Bags . . . . . 119, 193, 221  
 Ball Hoppers . . . . . 165  
 Ball Lockers/Ball Carriers . . . . . 330-333  
 Baseball/Softball Equipment Bags, Totes, Caddies . . . . . 64, 70-71  
 Bat Rack, Fence Mounted . . . . . 85  
 Duffie Bags . . . . . 70-71  
 Dugout Organizer Rack . . . . . 85  
 E-Z Fold Cart . . . . . 221, 331  
 Field Tarp Roller . . . . . 33  
 Fitness Carts . . . . . 333  
 Fitness Step Cart . . . . . 333  
 Floor/Street Hockey Transporter . . . . . 354  
 Football Equipment Bag . . . . . 119, 143  
 Football Helmet Cart . . . . . 142  
 Gym Floor Cover Mobile Storage Racks . . . . . 294  
 Helmet Rack/Tree . . . . . 85  
 Highboy Storage Shed . . . . . 85  
 Hurdle Carts . . . . . 202  
 Jump Rope Racks . . . . . 333, 345  
 Laundry Bags . . . . . 193, 284  
 Laundry Carts . . . . . 333  
 Mat Truck/Transporter . . . . . 277  
 Medicine Ball Racks . . . . . 249  
 Pit Transport Cart . . . . . 198  
 Playground Carts . . . . . 330-333  
 Racket Caddy . . . . . 167  
 Recess Rack . . . . . 333  
 Scooterboards . . . . . 332  
 Shot/Discus Carrier . . . . . 205  
 Shoulder Pad Rack . . . . . 142  
 Starting Block Cart . . . . . 201  
 Storage Sheds . . . . . 85  
 Tennis Ball Retrievers . . . . . 165  
 Volleyball Carry Bags . . . . . 221  
 Volleyball Carts . . . . . 221-222  
 Wall Mount Helmet Rack . . . . . 142  
 Storm Detector . . . . . 54  
 Streamers & Posts . . . . . 343  
 Street Hockey . . . . . 352-354  
 String Winder . . . . . 39  
 Swing Seats . . . . . 351  
 Table Games/Board Games . . . . . 303-305  
 Table Tennis . . . . . 296-298  
 Table Top Games . . . . . 303  
 Table Top Scoreboard . . . . . 221, 225, 313, 322  
 Take Off Boards . . . . . 206  
 Tape (Athletic) . . . . . 326-327  
 Tape, Floor Marking . . . . . 218  
 Tape, Mat . . . . . 277  
 Targets, Archery . . . . . 359  
 Team Walkers . . . . . 344  
 Teamwork Trekkers . . . . . 344  
 Team Shelter . . . . . 186  
 Template, Batters Box . . . . . 45  
**TENNIS . . . . . 158-169**  
 Ball Machines . . . . . 165  
 Balls . . . . . 168  
 Bench . . . . . 160  
 Carts . . . . . 165, 167  
 Nets . . . . . 158-159, 167  
 Paint . . . . . 166  
 Portable System . . . . . 161, 167, 346  
 Posts . . . . . 158  
 Quickstart, 10 & Under . . . . . 167-168, 346  
 Racquets . . . . . 169  
 Rol Dri . . . . . 160  
 Scorekeeper . . . . . 164  
 Tidi-Court . . . . . 164  
 Windscreen . . . . . 162-163  
 Tetherball . . . . . 351  
 Thigh Pads, Football . . . . . 138, 140  
 Thunder Thruster . . . . . 232  
 Tie Wraps . . . . . 25  
 Timers/Clocks . . . . . 317, 323  
 Tip-'N-Roll Bleachers . . . . . 10  
 Tooth Protectors . . . . . 143  
 Toppleball . . . . . 355  
 Toss Back Training Aid . . . . . 82-83  
 Towels . . . . . 151, 152  
**TRACK AND FIELD**  
 Batons . . . . . 201  
 Cages . . . . . 206  
 Circles . . . . . 206  
 Crossbars . . . . . 198-199  
 Discs . . . . . 204  
 Distance Markers . . . . . 205  
 High Jump Pits . . . . . 196-198  
 Hurdle Carts . . . . . 202  
 Hurdles . . . . . 202-203  
 Measuring Wheels . . . . . 206  
 Pit Cart . . . . . 198  
 Pole Vault Pits . . . . . 194-195  
 Scorebook . . . . . 207  
 Shots . . . . . 205  
 Spikes . . . . . 201  
 Standards . . . . . 198-199  
 Starting Blocks . . . . . 200  
 Stop Watches/Timers . . . . . 208-209, 385  
 Take Off/Toe Boards . . . . . 206  
 Tape Measures . . . . . 206  
 Vaulting Boxes . . . . . 199  
 Track Timing Clipboard . . . . . 207  
 Track Protectors . . . . . 128  
 Traffic Safety Vest . . . . . 329  
 Trainers Tape . . . . . 327  
 Training Gloves . . . . . 228  
 Training Multi-Purpose Sleds . . . . . 261  
 Training Platforms . . . . . 121, 231  
 Training Sled . . . . . 121, 261  
 Transportable Bleachers . . . . . 15  
 Trash Receptacle . . . . . 310  
 Treadmills . . . . . 242  
 Trophy Cases . . . . . 307  
 Tug-O-War Ropes . . . . . 344  
 Twine . . . . . 22, 39  
 Two-Way Radio . . . . . 287  
 Umpire Equipment . . . . . 77  
**UNIFORMS**  
 Baseball/Softball . . . . . 88-93  
 Basketball . . . . . 113-115  
 Football . . . . . 145  
 Volleyball . . . . . 220  
 Urban Rebounder . . . . . 258  
 Vault Box/Collar . . . . . 199  
 Vaulting Boards . . . . . 280  
 Vests . . . . . 144, 190, 262  
**VOLLEYBALL**  
 Antenna . . . . . 220  
 Bags . . . . . 221  
 Balls . . . . . 210-213, 244  
 Base Pad . . . . . 223  
 Boundary Markers . . . . . 224  
 Bungee Blocker . . . . . 219  
 Carts . . . . . 219, 221-222  
 Judges Stand . . . . . 217, 222  
 Knee Pads . . . . . 220  
 Linesman Flags . . . . . 219  
 Net Setter Chain . . . . . 220  
 Net Tension Straps . . . . . 220  
 Nets . . . . . 214-218  
 Pass Rite . . . . . 219  
 Pole Pads . . . . . 216-217, 222-223  
 Scorebook . . . . . 220  
 Scorekeeper . . . . . 221  
 Outdoor Sets . . . . . 224  
 Spikeblaster . . . . . 219  
 Standards . . . . . 223  
 Storage Racks . . . . . 218  
 Systems . . . . . 214-217  
 Target Challenger . . . . . 219  
 Tutor Machine . . . . . 219  
 Uniforms . . . . . 220  
 Volleyball Pal . . . . . 219  
 Walkway Runner Mats . . . . . 294  
 Wall Pads . . . . . 334-336  
 Wall Suction Cups, Wallyball . . . . . 219  
 Wallyball & Accessories . . . . . 219  
 Warning Cards & Wallet . . . . . 192  
 Washer Toss Game . . . . . 347  
 Water Bottles & Carrier . . . . . 150-151  
 Water Broom . . . . . 160  
 Water Coolers . . . . . 151-153, 164  
 Water Removers . . . . . 42, 178  
 Weather Cover . . . . . 33-35, 128-129, 194-197  
 Weight Collars . . . . . 226  
**WEIGHT EQUIPMENT**  
 Abdominal Exerciser . . . . . 235  
 Arm Curl Machine (Selectorized) . . . . . 238  
 Back & Abdominal Exercise Bench . . . . . 235  
 Bar Wrap Pads . . . . . 226  
 Belts . . . . . 228  
 Bench Press Machine (Selectorized) . . . . . 236, 239  
 Bumper Plates . . . . . 227  
 Cable Attachments . . . . . 234  
 Cable Crossover Machine . . . . . 239  
 Chalk . . . . . 228  
 Chest Press Machine (Selectorized) . . . . . 238  
 Chin & Dip Station . . . . . 235  
 Chin/Dip/Ab Station . . . . . 235  
 Competition Bench . . . . . 230  
 Curl Bars . . . . . 226  
 Curl Bench . . . . . 230  
 Decline Bench . . . . . 230  
 Dumbbell Racks . . . . . 229  
 Dumbbells . . . . . 229  
 Flat Bench . . . . . 230  
 Gloves . . . . . 228  
 Glute/Ham Bench . . . . . 233  
 Hack Squat Machine . . . . . 233  
 Hip Flexor Machine (Selectorized) . . . . . 236  
 Incline Bench . . . . . 230  
 Incline Rower (Plate Load) . . . . . 234  
 Incline Support Bench . . . . . 230  
 Jungle Systems . . . . . 237-239  
 Lat Pull & Row Machines . . . . . 234, 237, 239  
 Leg Extension/Leg Curl Machines . . . . . 233, 237, 239  
 Leg Press Machines . . . . . 233  
 Multi Bench . . . . . 230  
 Multi-Fit System . . . . . 237-239  
 Multi-Hip Flex . . . . . 236  
 Multi-Rack . . . . . 231-232  
 Multi-Station Machines . . . . . 237, 239  
 Neck Machine . . . . . 234  
 Olympic Style Bars . . . . . 226  
 Olympic-Style Weight Sets . . . . . 227  
 Pec Dec Machine (Selectorized) . . . . . 236  
 Power Bench . . . . . 230  
 Power Lift Platform . . . . . 231  
 Power Racks . . . . . 231-232  
 Power Ram Sled Hack-Machine/Leg Press . . . . . 233  
 Shoulder Press Machine (Selectorized) . . . . . 236  
 Sit Up Board . . . . . 240  
 Smith Machine . . . . . 232  
 Spring Collars . . . . . 226  
 Squat Rack . . . . . 232  
 Standard Bench . . . . . 230  
 Step Squat Rack . . . . . 232  
 Thunder Thruster . . . . . 232  
 Weight Plates . . . . . 227  
 Weightroom Racks . . . . . 231-232  
 Weight Lifting Chains . . . . . 226  
 Weight Lifting Resistance Bands . . . . . 226  
 Weighted Jump Ropes . . . . . 259  
 Weightroom Flooring . . . . . 240-241  
 Weightroom Racks . . . . . 231-232  
 Whistles . . . . . 284  
 Wiffle Ball . . . . . 63  
 Windscreen & Accessories . . . . . 26-27  
 Workout Steps . . . . . 258  
 Wrestling Equipment/Mats . . . . . 225  
 Wrist Roller . . . . . 226  
 Wristcoaches . . . . . 144  
 Yoga Mats . . . . . 254-255  
 Z-Balls . . . . . 262  
 Z-Cool . . . . . 134-135, 137-139

# **AC** ***Athletic Connection***

BASEBALL/SOFTBALL  
BASKETBALL  
FOOTBALL  
HYDRATION  
LACROSSE  
FIELD HOCKEY  
TENNIS  
RACQUETBALL  
BADMINTON  
SOCCER  
TRACK & FIELD  
VOLLEYBALL  
WRESTLING  
WEIGHT LIFTING  
CARDIO  
FLOORING  
CORE  
SPEED/AGILITY  
ASSESSMENT  
MATS  
GYMNASTICS  
BOXING  
COACHING  
CONCESSIONS  
FIELD MARKING  
FLOOR COVERS  
GAME TABLES  
LOCKS & LOCKERS  
BENCHES & BLEACHERS  
PARKS  
SCOREBOARDS  
SPORTS MEDICINE  
TRAFFIC SAFETY  
STORAGE  
WALL PADS  
PHYSICAL EDUCATION

